

TRES



IT EN CZ

listino prezzi price list ceník **2017**

TRES

www.tresgriferia.com

INDICE DEI CONTENUTI

TABLE OF CONTENTS

OBSAH

tres exclusive

SPAZIO DOCCIA / VASCA SHOWER / BATH SPACE SPRCHOVÝ / VANOVÝ PROSTOR	SERIE SERIES ŘADY	CUCINA KITCHEN KUCHYNĚ
Block System® 108	Slim exclusive 21	Monocomando Mixer taps 96 S jednopákovým mechanismem
Shower Technology® 160	Cuadro exclusive 39	Con manico estraibile With detachable spray nozzle 99 S výsuvnou sprškou
Mono-Term® 192	Study exclusive 51	Reclinabile Folding kitchen taps 100 Dřezová sklopná baterie
Monocomandi a 3 vie 3-way mixer taps 202 Jednopákové baterie se 3 přírady	Loft colors 71	Cucina a parete Wall kitchen 100 Nástěnné kuchyňské baterie
Programma per docce Bath space 215 Vanový prostor		

tres selection

SPAZIO DOCCIA / VASCA SHOWER / BATH SPACE SPRCHOVÝ / VANOVÝ PROSTOR	SERIE SERIES ŘADY	CUCINA KITCHEN KUCHYNĚ
Termostatiche Thermostatic 236 Termostatické	Cuadro-tres 377	Monocomando Mixer taps 520 S jednopákovým mechanismem
Gruppi termostatici Thermostatically-controlled sets 250 Termostatické soupravy	Max-tres 395	Con manico estraibile With detachable spray nozzle 528 S výsuvnou sprškou
Monocomandi Mixer taps 270 Baterie	Loft-tres 417	Reclinabile Folding kitchen taps 532 Dřezová sklopná baterie
Programma per docce Bath space 293 Vanový prostor	Class-tres 431	Elettronica Electronic kitchen taps 533 Dřezové elektronické baterie
	Lex-tres 443	Sistema trattamento acqua For water treatment 535 Dřezová baterie k úpravě vody
	Alplus 457	Industriale Industrial kitchen taps 536 Dřezová průmyslová baterie
	Flat-tres 469	Cucina a parete Wall kitchen 538 Nástěnné kuchyňské baterie
	K-tres 475	Doppio comando Dual-control 541 Dřezová kohoutková baterie
	Bm-tres 483	
	Monoclastic 1900 489	
	Clasic-tres 497	
	Retro-tres 505	
	Temporizzate / Elettroniche Fitted with timers / Electronic 545 S časovačem / Elektronické	

tres distribution

SERIE SERIES ŘADY

Monotres 2000	565
Eco-tres	571
Ese-23	579

RUBINETTERIA SPECIALE SPECIAL TAPWARE SPECIÁLNÍ BATERIE

Bidet Bidets Bidety	558
Rubinetteria medicale Medical fixtures Lékařská zařízení	560
Parrucchieri Hair salon fixtures Kadeřnictví	561
Cucina Kitchen Kuchyně	561
Giardino - Piscina Garden - Pool Zahrada - Bazén	562
Vino Wine Vino	563

ACCESSORI ACCESORIES VYBAVENÍ

Slim-tres	344
Cuadro-tres	345
Max-tres / Class-tres	346
Loft-tres	348
Retro-tres	350

COMPLEMENTI COMPLEMENTS PŘÍSLUŠENSTVÍ

Valvola Valve Ventil	354
Scarico vasca Bath drain Vanový sifon	360
Sifone Siphon Sifon	362
Rosone Cover plate Krycí rozeta	365
Erogatore Vasca Spout Výtoková hubice	365
Chiave di regolazione Adjustment key Uzavírací ventil	368
Limitatori di flusso Flow restrictors Omezovače průtoku	373
Ariatore Aerator Perlátor	374



N I PRODOTTI PIÙ IMPORTANTI
THE MOST IMPORTANT
TO NEJDŮLEŽITĚJŠÍ



Monocomandi a 3 vie per doccia con bocchette di idromassaggio. / 3-way mixer tap for shower with hydromassage jets. / Jednopakové trojcestné baterie pro sprchu s hydromasážními tryskami.



Monocomandi a 3 vie per vasca. / 3-way mixer tap for bath. / Jednopakové trojcestné baterie pro vanu.



Gruppi termostatici elettronici Shower Technology® a 4 vie. / 4-Way Shower Technology® electronic thermostats. / Čtyřcestné termostatické elektronické baterie Shower Technology®.



Gruppi termostatici elettronici Shower Technology® a 3 vie. / 3-Way Shower Technology® electronic thermostats. / Trojcestné termostatické elektronické baterie Shower Technology®.



Mono-Term®, la tecnologia dei monocomandi del futuro. / Mono-Term®: the mixer tap technology of the future. / Mono-Term® – technologie jednopákových baterií budoucnosti.



Gruppi termostatici da incasso Block System®. / Block System® built-in thermostats. / Vestavné termostatické baterie Block System®.

N I PRODOTTI PIÙ IMPORTANTI
THE MOST IMPORTANT
TO NEJDŮLEŽITĚJŠÍ



Lavabi Loft-Tres di differenti altezze e con canne più lunghe. / Loft-Tres sinks of different heights and with longer spouts. / Umyvadlové baterie Loft-Tres o různé výšce a s delšími ramínky.



Rubinetteria temporizzata ideale per spazi pubblici. / Timer tapware ideal for public spaces. / Baterie s časovým vypínačem, vhodné pro veřejné prostory.



Docce a mano con pulsante per scegliere i tipi di getto. / Press-button hand showers to choose water jet type. / Ruční sprchy s tlačítkem k volbě typu proudu.



Rubinetteria temporizzata a incasso ideale per spazi pubblici. / Built-in timer tapware ideal for public spaces. / Vestavné baterie s časovým vypínačem, vhodné pro veřejné prostory.



Cromoterapia con uscita d'acqua Micro-Drop. / Chromotherapy with Micro-Drop water outlet. / Chromoterapie s proudem vody Micro-Drop.



Soffioni INOX di grande formato. / Large stainless-steel spray nozzles. / Velkoformátová kroupitka INOX.



Cucine con finiture in Acciaio o Bianco opaco. / Kitchens with steel or white-matte finish. / Kuchyňské baterie s ocelovým nebo matně bílým povrchem.



Gruppi termostatici di superficie per vasca. / Surface-height thermostatic units for baths. / Povrchové termostatické soupravy pro vany.



LO SPIRITO DI TRES THE TRES SPIRIT DUŠE ZNAČKY TRES



Tradizione / Tradition / Tradice

Dalla sua fondazione nel 1968, lo spirito industriale di Tres combina l'ingegneria e la qualità delle grandi invenzioni con l'evoluzione di un'azienda familiare. / Since Tres was first established in 1968, its industrial spirit has been based on a combination of the engineering and quality of great inventions with the evolution of a family business. / Již od svého založení roku 1968 je v průmyslovém duchu společnosti TRES kombinováno inženýrství a kvalita velkých vynálezů s rozvojem rodinného podniku.



Fabbricazione / Fabrication / Výroba

Tutto il processo di fabbricazione, dall'idea fino al risultato finale, si realizza nelle installazioni di Tres. / The entire manufacturing process, from the idea to the end product, is executed on the Tres premises. / Celý proces výroby, od nápadu po samotný výrobek, je realizován ve vlastních instalacích společnosti Tres.



Sviluppo / Development / Vývoj

Ingegneria e ricerca che rivoluziona il mondo della rubinetteria e adatta i progressi tecnologici sia ai suoi prodotti che ai suoi processi di lavoro. / Engineering and research that have changed the tapware industry, adapting technological improvements to its products and work processes. / Inženýring a vývoj mění oblast baterií a adaptuje získané technologické poznatky jak na samotné výrobky, tak i na pracovní postupy.

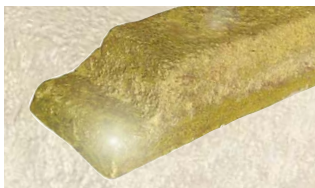

Qualità / Quality / Kvalita

Prodotti fabbricati con materiali garantiti, dalla materia prima come l'ottone fino al bagno in cromo. Con i processi di controllo di qualità più esigenti. / Products made with materials that are guaranteed, from raw materials such as brass, to chrome-plating. With the most stringent quality control processes. / Pro výrobu produktů jsou použity kvalitní materiály, ať již jde o prvotní suroviny jako mosaz nebo materiály pro závěrečné úpravy jako chrom. Celý proces je podroben nejpřísnějším kontrolám kvality.



Design / Design / Design

La maggior varietà di prodotti e design per trovare quello che si adatta meglio a ciascuno stile. Funzionalità senza rinunciare alla migliore decorazione e comodità. / The widest range of products and designs, to allow you to find the one that adapts best to each style. Functionality without renouncing the most exquisite decoration and comfort. / Velký výběr výrobků a designů, které vyhoví nejrůznějším stylům spotřebitele. Maximální funkčnost, bez nutnosti vzdát se estetiky či pohodlí.



Esposizione / Showroom / Expozice

Esposizione permanente nello showroom TRES TRAINING CENTER per vedere a pieno regime il piacere dell'acqua e la tecnologia di Tres. / Its permanent showroom at the TRES TRAINING CENTER lets customers experience the pleasure of water and the TRES technology for themselves. / Na permanentní expozici v showroomu TRES TRAINING CENTER je dobře vidět funkčnost technologie Tres a požitek z vody, který přináší.

I prodotti TRES sono prodotti integralmente in Spagna con materie prima di altissima qualità e di origine europea. I componenti e le aleazioni di ottone utilizzate da TRES soddisfano appieno le più esigenti normative di sicurezza, incluso la UBA (Agenzia Federale Tedesca per l'Ambiente) normativa DIN 50930 (EN 12164).

The TRES products are all made in Spain entirely with european first quality raw material. The components and brass alloys used by TRES, complish the strictest safety norms, including the norm DIN 50930 (EN 12164) from the UAB (German Federal Environmental Agency).

Tres Všechny výrobky jsou vyráběny výhradně ve Španělsku z vysoce kvalitních materiálů evropského původu. Komponenty a mosazné slitiny používané firmou Tres splňují nejprísnější bezpečnostní standardy, včetně UBA (Německá spolková agentura pro životní prostředí) podle DIN 50930 (EN 12164).



DOCCE PER TUTTI I GUSTI SHOWERS TO SUIT ALL TASTES SPRCHY PRO VŠECHNY

Monocomandi / Mixer taps / Jednopákové baterie

Con design adattabili e molte possibilità, è un'opzione semplice ed estremamente funzionale per un grande piacere nella doccia. / With adaptable designs and many possibilities, they offer a simple and extremely functional option for an enjoyable shower. / Díky množství možností a rozličným designům jsou jednoduchou a vysoce funkční alternativou pro skvělý zážitek ze sprchování.

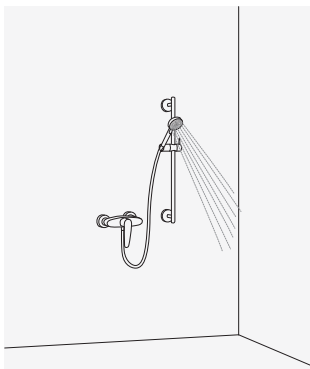

Gruppi da superficie.
Surface-mounted mixer tap sets.
Povrchové soupravy.

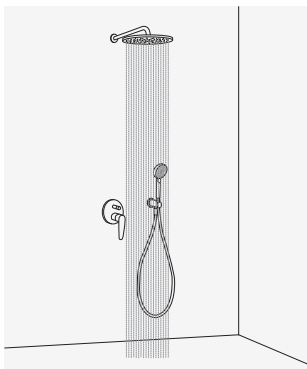

Gruppi incassati.
Built-in sets.
Vestavěné soupravy.

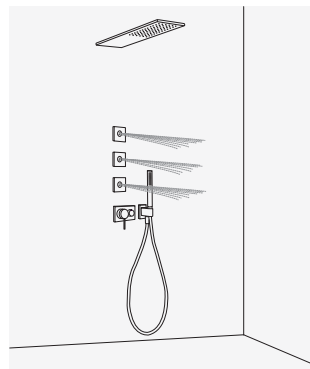

Gruppi incassati a 3 vie.
Built-in 3-way sets.
Vestavěné soupravy se 3 přívody.

Mono-Term®

La semplicità dei monocomandi ma con una cartuccia rivoluzionaria che offre prestazioni simili a quelle di una rubinetteria termostatica. / The simplicity of a mixer tap, but with a revolutionary cartridge with features similar to those of a thermostatic tap. / Díky své jednoduchosti a svému revolučnímu náboji poskytují jednopákové baterie obdobné možnosti jako baterie termostatické.

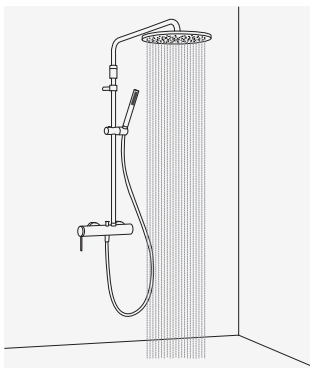

Gruppi da superficie.
Surface-mounted mixer tap sets.
Povrchové soupravy.



Gruppi incassati.
Built-in sets.
Vestavěné soupravy.

Termostatiche / Thermostatic / Termostatické

Il controllo massimo della temperatura e della doccia. Le maggiori prestazioni con diversi formati, design e funzionalità. / Maximum temperature and shower control. New, improved features with different formats, designs and functionalities. / Maximální kontrola teploty vody ve sprše. Vysoká výkonnost bez ohledu na formát, design či funkce.

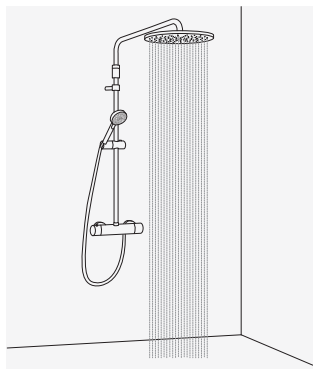

Gruppi termostatici di superficie.
Surface-mounted thermostatic taps.
Povrchové termostatické baterie.

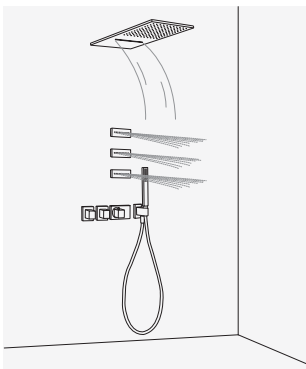

Gruppi incassati con varie funzioni.
Built-in sets with different functions.
Vestavěné soupravy s různými funkcemi.

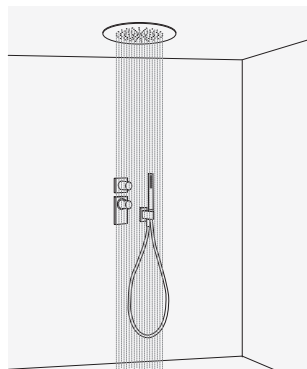

Gruppi incassati a soffitto.
Built-in ceiling-mounted sets.
Soupravy vestavěné do stropu.

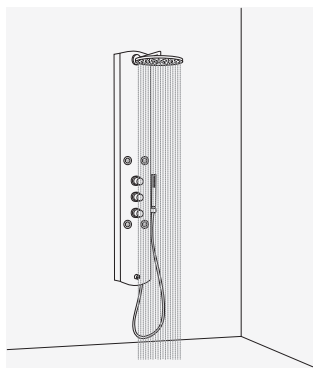

Colonne doccia multifunzioni.
Multifunctional shower columns.
Multifunkční sprchové panely.

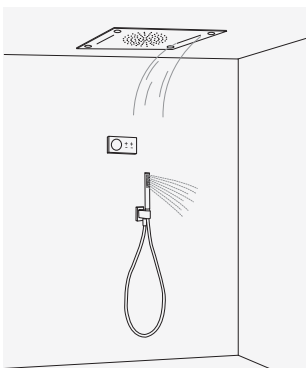

Gruppi con pannello digitale elettronico.
Sets with digital electronic control panels.
Soupravy s elektronickým digitálním panelem.

SISTEMI PER LA DOCCIA PIÙ EFFICIENTI MORE EFFICIENT SHOWER SYSTEMS SYSTÉMY PRO VÝKONNĚJŠÍ SPRCHY

Monocomandi / Mixer taps / Jednopákové baterie



Una soluzione semplice e di facile installazione con differenti design e forme che si adattano a qualsiasi spazio. I monocomandi spiccano per la loro funzionalità, un comodo uso da un solo telecomando e alta resistenza al passare del tempo. / A simple solution, easy to install and with different designs and shapes that can be adapted to any space. The predominant features of the mixer taps are their functionality, ease of operation with a single control and durability. / Jednoduché řešení se snadnou montáží a rozličnými designy, které se přizpůsobí jakémukoliv prostoru. Jednopákové baterie vynikají díky své funkčnosti, pohodlnému ovládnání a vysoké odolnosti vůči stárnutí.

P in "Serie" a pagina 202 e 270. / in "Series" and on page 202 and 270. / V oddílu "Řady" na straně 202 na 270.



Mono-Term®



Mono-Term® è un sistema unico e rivoluzionario ideato da Tres che segna il futuro nella fabbricazione di rubinetteria. L'uso è come quello dei monocomandi, ma offre delle prestazioni simili a quelle di un gruppo termostatico: mantiene la temperatura costante, basso livello acustico, sicurezza e precisione. / Mono-Term® is a unique new system designed by Tres which sets the future trend in tapware. It is just as easy to operate as a mixer tap, but with features similar to those of a thermostatic tap: it maintains the temperature constant, low noise levels, safety and precision. / Mono-Term® je jedinečný a revoluční systém značky Tres udávající krok do budoucnosti ve výrobě baterií. Ovládnání je stejné jako v případě jednopákových baterií, avšak s výkonem a schopnostmi baterií termostatických: udržuje stálou teplotu, nízkou hladinu hluku, je bezpečný a přesný.

P a pagina 192. / on page 192 / Na straně 192.



Termostatiche / Thermostatic / Termostatické



Controllo totale della temperatura, con cartucce che garantiscono un flusso d'acqua costante, di facile uso, con deviatore integrato al regolatore di flusso e dai design diversi con differenti funzioni e prestazioni. / Full temperature control, with cartridges that guarantee a constant water flow rate, easy to operate, with a built-in flow control inverter and different designs with different functions and features. / Maximální kontrola teploty, díky kartuším zaručující konstantní průtok, jednoduchému ovládnání pomocí zabudovaného regulátoru průtoku a rozličným designům s různými schopnostmi a funkcemi.

P in "Serie" a pagina 236. / in "Series" and on page 236. / V oddílu "Řady" na straně 236.



Block system®

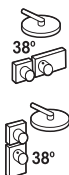

Gruppi termostatici da incasso di grande semplicità e bellezza, con controllo preciso della temperatura e un'infinità di combinazioni. Inoltre, il sistema block system è caratterizzato dalla sua semplicità di installazione e di allineamento degli elementi. / **Built-in thermostatic taps with a simple and attractive design, precise temperature control and endless combinations. In addition, the block system is characterised by its simplicity in terms of installation and alignment of elements.** / Vestavěné termostatické soupravy s jednoduchým a atraktivním vzhledem, přičemž umožňují přesné nastavení teploty a nabízí nespočet možností využití. Navíc jsou vybaveny block-systémem vyznačujícím se jednoduchostí pro instalaci a možností sladěni jednotlivých prvků.

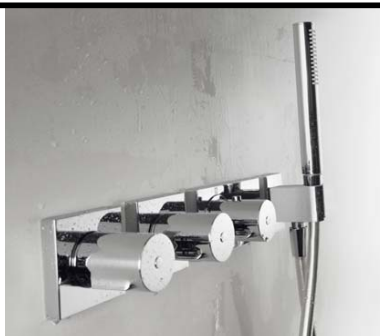

 in "Serie Exclusive" a pagina 108. / in "Series Exclusive" and on page 108. / V oddílu "Řady Exclusive" na straně 108.

Shower Technology®



Tramite il pannello touch digitale si seleziona la temperatura e le diverse uscite dell'acqua facilmente e intuitivamente, per creare un'esperienza unica e personale. La centralina termostatica si può installare in qualsiasi parte della casa. / **The digital touch-operated panel means you can program the temperature and water outlet flow easily and intuitively to create a unique, personal experience. The thermostatic regulator can be installed in any part of the home.** / Na dotykovém digitálním panelu si můžete snadno a přehledně naprogramovat teplotu a tok vody a vytvořit si tak jedinečný osobní zážitek. Termostatickou jednotku pak můžete umístit na jakékoliv místo ve Vašem domově.



 in "Serie Exclusive" a pagina 160 e 248. / in "Series Exclusive" and on page 160 and 248. / V oddílu "Řady Exclusive" na straně 160 na 248.

Colonne doccia / Shower columns / Sprchové panely



In un solo sistema sono integrati il soffione, la doccia a mano e le bocchette tonificanti per usufruire delle massime prestazioni di un prodotto termostatico che offre l'opportunità di godere del relax e dell'acqua allo stato puro. / **The shower head, hand shower and toning jets are built into a single system, to make full use of the features of a thermostatic product that offers you the opportunity to relax and enjoy water in its purest state.** / Jediný systém tak nabízí křopítko, ruční sprchu a masážní trysky, díky čemuž můžete zcela využít funkci této termostatické soupravy a užít si zážitek z vody v rozličných podobách.



 a pagina 266. / on page 266 / Na straně 266.

LAVABI FUNZIONALI E CON PERSONALITÀ FUNCTIONAL WASHBASINS WITH THEIR OWN PERSONALITY FUNKČNÍ A OSOBITÁ UMYVADLA

Scegliete il modello ideale / Select the ideal model / Vyberte si ideální model

L'altezza e la forma del lavandino, nonché il design del bagno, influiscono nella scelta del rubinetto da lavabo ideale.
The height and shape of the washbasin, and the bathroom design have an influence on the choice of the ideal tapware for the washbasin.
Výška a tvar umyvadla, stejně tak jako vzhled koupelny, mají významný vliv při výběru vodovodní baterie.

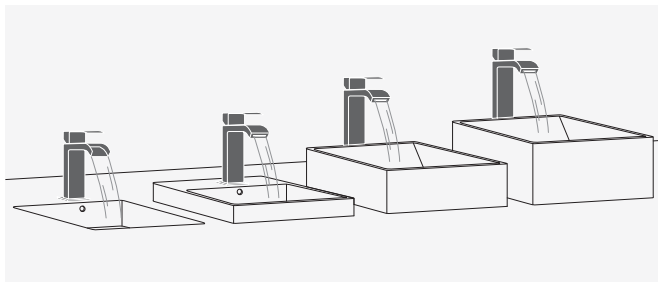

Rubinetti da lavabo convenzionali per lavelli per il piano cucina o con corpi più alti per lavelli da piano cucina di diverse altezze.

Conventional washbasin tapware for countertop basins or with higher bodies for above counter basins of different heights.

Konvenční baterie pro umyvadla vestavěná v toaletním stole či baterie vyšší, určené pro umyvadla o různých výškách, umístěná na toaletním stole.

Rubinetti da lavabo, monocomando o a doppio comando, con canne di differente altezza e distanza, ideali per piani cucina speciali.

Washbasin taps, mixer taps or dual control taps, with spouts of different heights and distances, perfect for special countertops.

Baterie běžné umyvadlové, baterie s jednou či dvěma pákami, s kohoutky s různými výškami a vzdálenostmi, ideální pro speciální pracovní plochy či toaletní plochy.

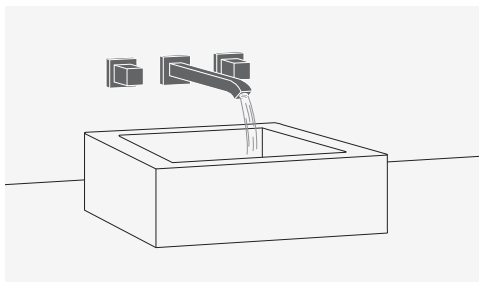
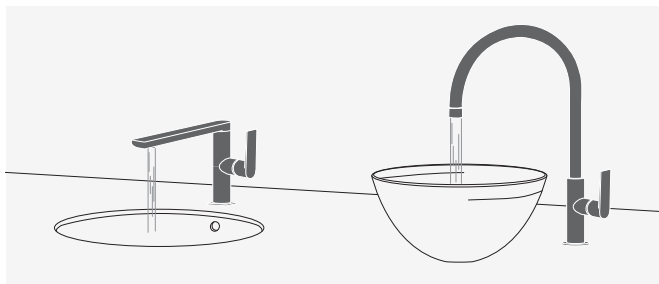

La rubinetteria a parete libera lo spazio del piano cucina, offre maggiore lunghezza della canna e adattabilità in altezza.

Wall-mounted taps free up counter space, with the option of longer spouts and adaptable heights.

Baterie vestavěné do zdi uvolňují prostor na pracovní či toaletní ploše a nabízí delší kohoutek s nastavitelnou výškou.

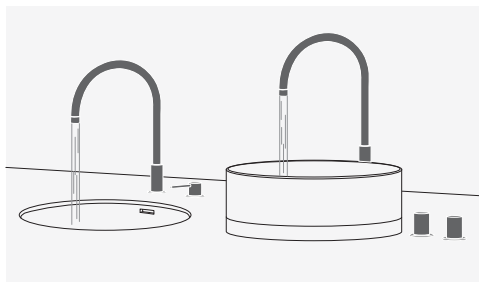

Il telecomando dei rubinetti a mensola si installa separatamente dalla canna, dove è più comodo da usarsi. Anche con diverse altezze.

Over-counter taps can be installed separately from the spout, in areas that are more appropriate for their use. Also supplied with different heights.

Ovládací páka baterie a její kohoutek se instalují zvlášť do polohy pohodlné pro její použití. S možností nastavení do různých výšek.

Caratteristiche generali / General characteristics / Všeobecné vlastnosti



Design per ogni spazio. Grande varietà di modelli con stili che si adattano a ciascun ambiente.

A design for each space. Large variety of models, with styles that are adapted to each space.

Design vhodný pro jakýkoliv prostor. Velké množství modelů a stylů, které se přizpůsobí jakémukoliv prostředí.



Dischi ceramici. Funzionamento delicato del comando con prolungata vita utile della cartuccia.

Ceramic discs. Smooth-operating handle and cartridge, with a long useful life.

Keramické disky. Jemný pohyb páky umožňuje delší životnost kartuše.



Diverse altezze. Per scegliere la migliore opzione secondo l'altezza e la forma del lavello.

Different heights. So that you can choose the best option, depending on the height and shape of the washbasin.

Různé výšky. Pro správnou volbu vzhledem k výšce a tvaru umyvadla.



Valvola SIMPLE-RAPID. Valvola con blocco superiore.

Ventil SIMPLE-RAPID. Valve with upper blockage.

SIMPLE-RAPID valve. Ventil s vrchním blokováním.



Diverse uscite d'acqua. Diversi modi di lasciar cadere l'acqua, come una cascata o con rompigetto.

Different water outlets. Different ways for the water to emerge, in a gush or in droplets with an aerator.

Různé výstupy pro vodu. Voda může vycházet rozličnými způsoby, jako například kaskáda či voduchovy šetrčí.



Sistema antiscozzature Protec-Tres®. Scelta della posizione massima della leva per l'acqua calda.

Protec-Tres® anti-scald system. Option of choosing the maximum position of the lever for hot water.

Systém proti opaření Protec-Tres®. Volba maximální polohy pro výstup horké vody.



Cromatura di alta resistenza. La cromatura Tres-Micron® è duratura e facile da pulire.

High-resistance chrome plating. Tres-Micron® chrome plating is durable and easy to clean.

Chromování s vysokou odolností. Chromování Tres-Micron® je trvanlivé a snadno se čistí.

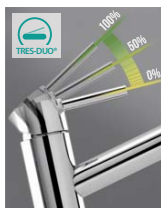

Risparmio idrico Tres-Duo®. Due posizioni di apertura della manopola. Nella posizione intermedia si consuma la metà.

Tres-Duo® water savings. Two handle opening positions. Half the consumption in the middle position.

Úspora vody Tres-Duo®. Dvě polohy páky pro otevření kohoutku. V prostřední poloze je spotřeba vody poloviční.

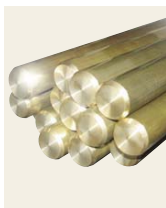

Ottone garantito. Fabricato con ottone in lega CB755S, con basso livello di piombo, nel rispetto della normativa europea.

Guaranteed brass. Made of alloy CB755S brass, with a low lead content, in compliance with European standards.

Kvalitní mosaz. Vyrobeno z mosazi slitiny CB755S, s nízkým množstvím olova, a v souladu s evropskými směrnici.

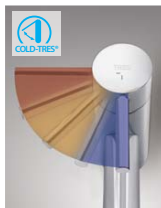

Risparmio energetico Cold-Tres®. Il rubinetto si apre sempre con l'acqua fredda, evitando inutili accensioni dello scaldabagno.

Cold-Tres® energy savings. The tap always turns on with cold water, preventing unnecessary activation of the water heater.

Úspora energie Cold-Tres®. Baterie se vždy spouští se studenou vodou a zamezuje tak zbytečnému spouštění ohřivače.

* I modelli con sistemi ecoefficienti vengono indicati con il simbolo corrispondente.

*Eco-efficient system models are marked with the corresponding symbol.

*Modely vybavené EKO-efektivními systémy jsou uvedeny společně s odpovídajícím symbolem.

QUANDO LA CUCINA È UN PIACERE
WHEN THE KITCHEN IS A GREAT PLACE TO BE
POTĚŠENÍ Z KUCHYNĚ



Cucine per tutti gli usi
Kitchens for all uses
Kuchyně pro všechna použití



Monocomando. Un'unica leva o manopola per regolare la temperatura e il flusso con un semplice movimento.

Mixer tap. A single lever or control to adjust the temperature and flow rate in a simple gesture.

Jednopákové baterie. Jediná páka nebo kohout pro nastavení teploty a průtoku jedním snadným pohybem.



Doppio comando. Controllo con due comandi o manopole indipendenti, uno per l'acqua fredda e un altro per la calda.

Dual control. Dual control or separate controls, one for cold water and the other for hot water.

Dvoupákové baterie. Ovládání pomocí dvou nezávislých pák či kohoutů, jednoho pro vodu studenou a druhého pro horkou.



Reclinabile. Ideale per l'installazione di fronte a finestre o armadi. Il rubinetto ruota e si stende quando è necessario.

Folding. Ideal when installed in front of windows or cupboards. The tap rotates and can be folded when necessary.

Sklápěcí. Ideální pro instalaci u oken či skříněk. Baterie se otáčí či sklápí vždy, když je to zapotřebí.



Canna estraibile. La doccia e la canna estraibili permettono di estendere la zona di lavoro da 50 a 70 cm.

Detachable spout. Detachable showers and spouts allow the operating area to be widened from 50 to 70 cm.

Výsuvná trubice. Výsuvná sprcha či trubice umožňuje rozšíření pracovní plochy o 50 až 70 cm.



Trattamento dell'acqua. In cucina acqua filtrata priva di cloro, con una stessa canna e due diverse condotte. Anche per sistemi di osmosi.

Water treatment. Chlorine-free filtered water in the kitchen with a single spout and two different tubes. Also for osmosis systems.

Ošetření vody. Filtrovaná voda v kuchyni, bez chlóru, s jedním kohoutkem a dvěma různými přívody. Také pro systémy na bázi osmózy.



Rubinetteria a parete. Combina autenticità, qualità e minimalismo delle forme, con diverse lunghezze della canna.

Wall-mounted tapware. Their shapes are a combination of authenticity, quality and minimalism, with different spout lengths.

Baterie vestavěné do stěny. Kombinace kvality, pravosti a minimalizmu, s různými délkami kohoutku.



Rubinetteria elettronica. Garantisce un maggiore livello di igiene, comfort e sicurezza.

Electronic tapware. Guarantees greater hygiene, comfort and safety.

Elektronické baterie. Zaručuje vyšší úroveň hygieny, pohodlí a bezpečnosti.



Industriale. Uscita alta e girevole, per garantire libertà di movimento e facilitare il lavoro in cucina.







































Industrial taps. These taps facilitate work in the kitchen, as they come with a high revolving output level, ensuring total freedom of movement.

Industriální. Uspadňují práci v kuchyni díky zabudovanému zvýšenému a otočnému výstupu, který zaručuje volnost pohybu.

UN MONDO DI ISPIRAZIONE ALLA VOSTRA PORTATA
A WORLD OF INSPIRATION AT YOUR FINGERTIPS
SVĚT INSPIRACE NA DOSAH

www.tresgriferia.com



Slim exclusive			Cuadro-tres
Cuadro exclusive			Max-tres
Study exclusive			Loft-tres
Loft colors			Class-tres
Cocina exclusive			Lex-tres
Block system®			Aplus
Shower technology®			Flat-tres
Mono-term®			K-tres
Monocomandi a 3/2 vie 3/2-way mixer taps Jednopákové baterie se 3/2 přívody			Bm-tres
Programma per docce exclusive Bath space exclusive Vanový prostor exclusive			Monoclastic 1900
Termostatiche Thermostatic Termostatické			Clasic-tres
Gruppi termostatici Thermostatically-controlled sets Termostatické soupravy			Retro-Tres
Monocomandi Mixer taps Baterie			Cucina exclusive Kitchen exclusive Kuchyně exclusive
Programma per docce selection Bath space selection Vanový prostor selection			Temporizzate / Elettroniche Fitted with timers/Electronic S časovačem/Elektronické
Accessori Accessories Vybavení			Rubinetteria speciale Special tapware Speciální baterie
Complementi Complements Příslušenství			Monotres 2000
			Eco-tres
			Ese-23
			Lista di codici articoli List of product references Seznam referencí





SLIM EXCLUSIVE



Lavabi
Basin mixer taps
Koupelňová baterie



Bidets
Bidets
Bidety



Monocomando esterno
Bathtub mixer taps
Jednopákový mechanismus vany



Monocomando ad incasso
Built-in sets
Vestavěné soupravy



Bordovasca
Deck-mounted bathtubs
Vany s prodlouženým pultem



Termostatica esterna
Thermostatically-controlled
Termostatické



Termostatica ad incasso
Concealed thermostatic mixer
Podomítková termostatická baterie



Termostatica elettronica ad incasso
Built-in electronic thermostatic
Podomítková termostatická elektronická



Accessori
Accessories
Vybavení



RICAMBI SU
SPARE PARTS AT
NÁHRADNÍ DÍLY NA
www.tresgriferia.com

www.tresgriferia.com





Monocomando lavabo
Single lever washbasin mixer
Jednöpáková umyvadlová baterie

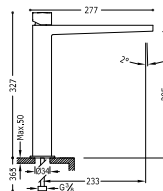
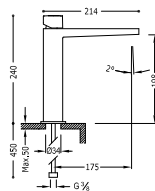
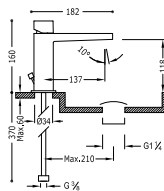

Monocomando lavabo
Single lever washbasin mixer
Jednopáková umyvadlová baterie

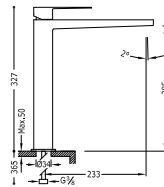
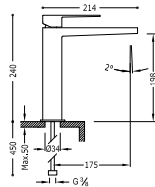
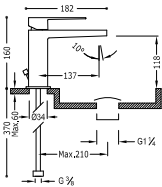

Monocomando lavabo
 Single lever washbasin mixer
 Jednoplávková umyvadlová baterie

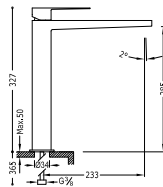
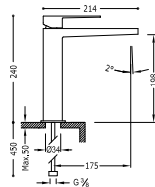
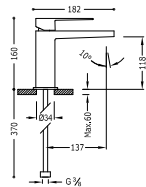
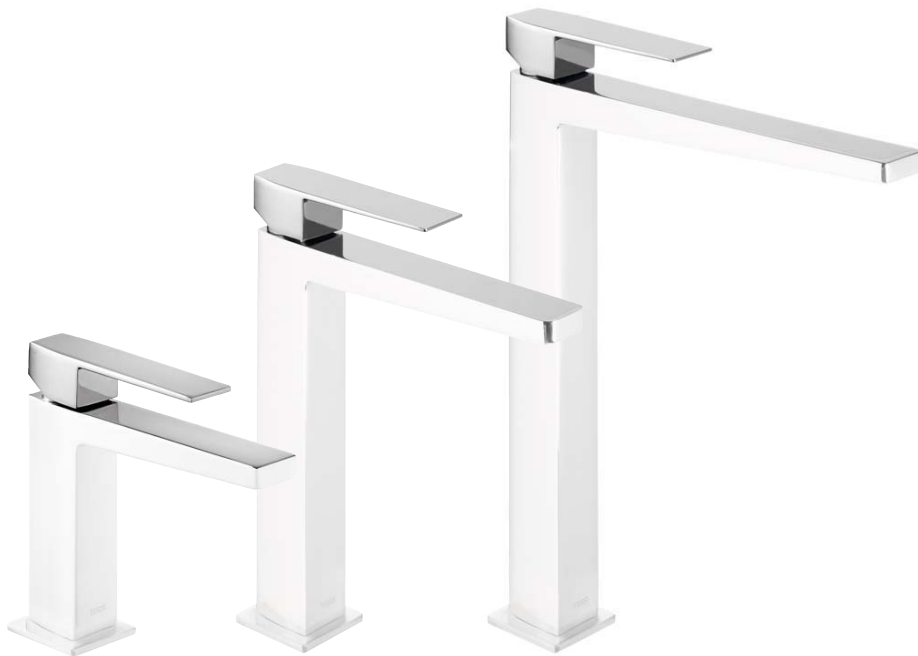

91.30.190	91.30.190	91.30.190
Ac	202.103.01.ACD	
	202.103.01.NED	
	202.103.01.BLD	

91.30.190	91.30.190	91.30.190
Ac	202.103.03.ACD	
	202.103.03.NED	
	202.103.03.BLD	

91.30.190	91.30.190	91.30.190
Ac	202.103.05.ACD	
	202.103.05.NED	
	202.103.05.BLD	

Monocomando lavabo

con bocca a cascata aperta. **NOTA:** La rubinetteria con canna a cascata è accompagnata da 2 rubinetti di regolazione con filtro (Ref: 91.34.525)

Single lever washbasin mixer

with open cascade spout. **NOTE:** Taps with a cascade spout come with 2 regulation valves and a filter (Nr.: 91.34.525)

Jednopáková umyvadlová baterie

ramínko s otevřeným vodopádem. **POZNÁMKA:** Baterie typu vodopádu je doplňena dvěma regulačními kohouty s filtrem (Kód.: 91.34.525)

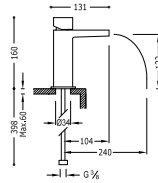

91.30.190

Cr 202.110.02

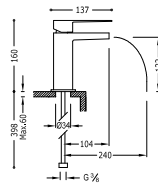

91.30.190

Cr 202.110.01



Monocomando lavabo

con bocca a cascata aperta. **NOTA:** La rubinetteria con canna a cascata è accompagnata da 2 rubinetti di regolazione con filtro (Ref: 91.34.525)

Single lever washbasin mixer

with open cascade spout. **NOTE:** Taps with a cascade spout come with 2 regulation valves and a filter (Nr.: 91.34.525)

Jednopáková umyvadlová baterie

ramínko s otevřeným vodopádem. **POZNÁMKA:** Baterie typu vodopádu je doplňena dvěma regulačními kohouty s filtrem (Kód.: 91.34.525)

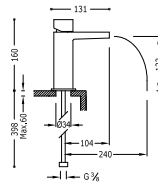

91.30.190

202.110.02.NE.D

202.110.02.BL.D

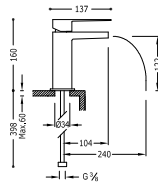

91.30.190

202.110.01.NE.D

202.110.01.BL.D



Monomando a muro

Single lever wall washbasin mixer

Jednopáková nástěnná baterie

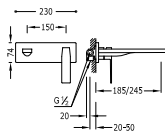

91.30.190

Cr 202.200.03 (185 mm.)

Cr 202.200.03



91.30.190

Cr 202.200.04 (245 mm.)

Ac 202.200.04.AC

Monocomando bide
Single lever bidet mixer
Jednopávková bidetová baterie

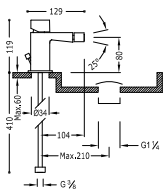

Cr	202.120.02	
Cr	202.120.02.D	

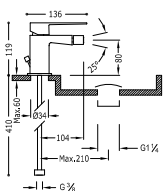

Cr	202.120.01	
Cr	202.120.01.D	

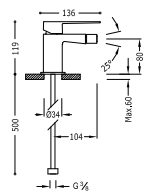

Monocomando bide
Single lever bidet mixer
Jednopávková bidetová baterie

Ac	202.120.01.ACD	
	202.120.01.NE.D	
	202.120.01.BLD	

MONOCOMANDI BAGNO / BATHTUB MIXER TAPS / JEDNOPÁVKOVÝ MECHANISMUS YANY

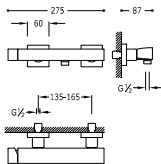

Monocomando doccia
Doccetta anticalcare (202.639.01) con supporto orientabile.
Flessibile satin (91.34.609.15).

Single lever shower mixer
Anti-limescale hand shower (202.639.01) with directable support.
Shower hose satin (91.34.609.15).

Jednopávková sprchová baterie
Ruční sprcha (202.639.01) s nastavitelným držákem, proti usaz. vod. kamene.
Flexi hadice SATIN (91.34.609.15)

Cr	202.167.01	

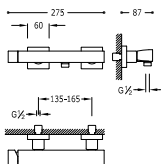

Monocomando doccia
Doccetta anticalcare con supporto orientabile. Flessibile satin (91.34.609.15).

Single lever shower mixer
Anti-limescale hand shower with directable support. Shower hose satin (91.34.609.15).

Jednopávková sprchová baterie
Ruční sprcha s nastavitelným držákem, proti usaz. vod. kamene.
Flexi hadice SATIN (91.34.609.15).

Ac	202.167.01.AC	
	202.167.01.NE	
	202.167.01.BL	



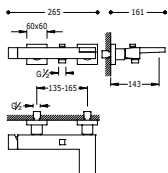

Monocomando vasca
Doccetta anticalcare (202.639.01) con supporto orientabile.
Flessibile satin (91.34.609).

Single lever bath and shower mixer
Anti-limescale hand shower (202.639.01) with directable support.
Shower hose satin (91.34.609).

Jednopávková baterie pro vanu-sprchu
Ruční sprcha (202.639.01) s nastavitelným držákem, proti usaz. vod. kamene. Flexi hadice SATIN (91.34.609).



91.30.190

Cr | **202.170.01**

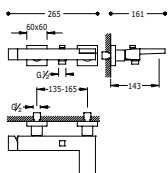

Monocomando vasca
Doccetta anticalcare con supporto orientabile. Flessibile satin (91.34.609).

Single lever bath and shower mixer
Anti-limescale hand shower with directable support. Shower hose satin (91.34.609).

Jednopávková baterie pro vanu-sprchu
Ruční sprcha s nastavitelným držákem, proti usaz. vod. kamene. Flexi hadice SATIN (91.34.609).



91.30.190

Ac | **202.170.01.AC**

■ | **202.170.01.NE**

■ | **202.170.01.BL**

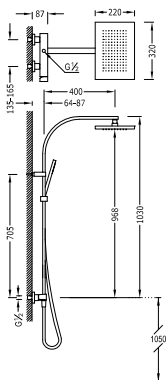

Kit doccia
- Doccia fissa 320x220 mm. con snodo. (299.632.02).
- Doccetta anticalcare (202.639.01).
- Flessibile satin (91.34.609.15).

Concealed shower set
- Fixed shower head 320x220 mm. with ball joint. (299.632.02).
- Antilime hand shower (202.639.01).
- Satin hose (91.34.609.15).

Sprchový set
- Hlavová sprcha 320x220 mm. s kloubem. (299.632.02).
- Ruční sprcha, proti usaz. vod. kamene (202.639.01).
- Flexi hadice SATIN (91.34.609.15).



91.30.190

Cr | **202.191.01**

GRUPPI AD INCASSO / BUILT-IN SETS / VESTAVĚNÉ SOUPRAVY

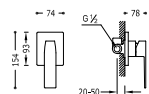

Monocomando incasso (1 via)
corpo incassato incluso

Built-in mixer taps (1 way)
Built-in body included

Vestavěná jednopávková baterie (jednocestný)
včetně podomítkového tělesa



91.30.190

Cr | **202.177.02**



91.30.190

Cr | **202.177.01**

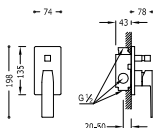

Monocomando incasso (2 vie)
corpo incassato incluso

Built-in mixer taps (2 way)
Built-in body included

Vestavěná jednopávková baterie (dvocestný)
včetně podomítkového tělesa



91.30.190

Cr | **202.180.02**



91.30.190

Cr | **202.180.01**

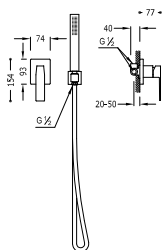
**Kit doccia ad incasso**

Con chiusura e regolazione di portata.

- Corpo incassato incluso
- Supporto per doccia (006.182.01).
- Doccetta anticalcare (202.639.01).
- Flessibile satin (91.34.609.15).

Concealed shower set

with water shut off and flow control.

- Built-in body included
- Elbow wall (006.182.01).
- Antilime hand shower (202.639.01).
- Satin hose (91.34.609.15).

Podomítkový jednopákový sprchový set

s uzávěrem a regulací průtoku.

- Včetně podomítkového tělesa
- Držák s nástěnným přívodem vody (006.182.01).
- Ruční sprcha, proti usaz. vod. kamene (202.639.01).
- Flexi hadice SATIN (91.34.609.15).



91.30.190

Cr 202.177.03

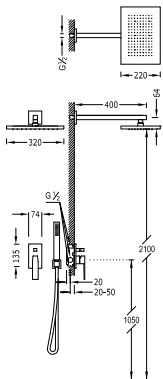
**Kit doccia ad incasso**

Con chiusura e regolazione di portata.

- Corpo incassato incluso
- Doccia fissa 320x220 mm. con snodo. Ottone (299.632.02).
- Supporto per doccia (006.182.01).
- Doccetta anticalcare (202.639.01).
- Flessibile satin (91.34.609.15).

Concealed shower set

with water shut off and flow control.

- Built-in body included
- Fixed shower head 320x220 mm. with ball joint. Brass (299.632.02).
- Elbow wall (006.182.01).
- Antilime hand shower (202.639.01).
- Satin hose (91.34.609.15).

Podomítkový jednopákový sprchový set

s uzávěrem a regulací průtoku.

- Včetně podomítkového tělesa
- Pevná sprcha 320x220 mm. s kloubem. Materiál mosaz (299.632.02).
- Držák s nástěnným přívodem vody (006.182.01).
- Ruční sprcha, proti usaz. vod. kamene (202.639.01).
- Flexi hadice SATIN (91.34.609.15).



91.30.190

Cr 202.180.06

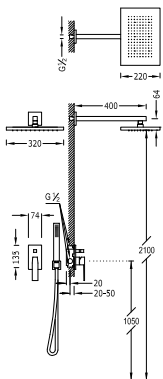
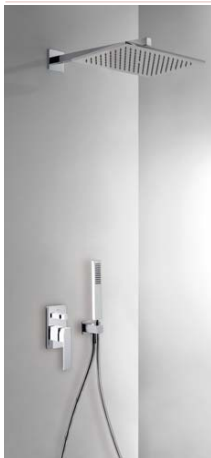
**Kit doccia ad incasso**

Con chiusura e regolazione di portata.

- Corpo incassato incluso
- Doccia fissa 320x220 mm. con snodo. Ottone.
- Supporto per doccia.
- Doccetta anticalcare.
- Flessibile satin (91.34.609.15).

Concealed shower set

with water shut off and flow control.

- Built-in body included
- Fixed shower head 320x220 mm. with ball joint. Brass.
- Elbow wall.
- Antilime hand shower.
- Satin hose (91.34.609.15).

Podomítkový jednopákový sprchový set

s uzávěrem a regulací průtoku.

- Včetně podomítkového tělesa
- Pevná sprcha 320x220 mm. s kloubem. Materiál mosaz.
- Držák s nástěnným přívodem vody
- Ruční sprcha, proti usaz. vod. kamene.
- Flexi hadice SATIN (91.34.609.15).



91.30.190

202.180.06.NE

202.180.06.BL



N

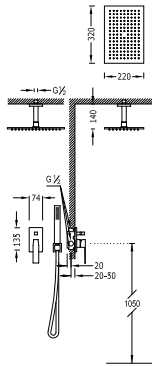

Kit doccia ad incasso

Con chiusura e regolazione di portata.

- Corpo incassato incluso
- Doccia fissa 320x220 mm. con snodo. Ottone (299.632.02).
- Supporto per doccia (006.182.01).
- Doccetta anticalcare (202.639.01).
- Flessibile satin (91.34.609.15).

Concealed shower set

with water shut off and flow control.

- Built-in body included
- Fixed shower head 320x220 mm. with ball joint. Brass (299.632.02).
- Elbow wall (006.182.01).
- Antilime hand shower (202.639.01).
- Satin hose (91.34.609.15).

Podomítkový jednopákový sprchový set

s uzávěrem a regulací průtoku.

- Včetně podomítkového tělesa
- Pevná sprcha 320x220 mm. s kloubem. Materiál mosaz (299.632.02).
- Držák s nástěnným přívodem vody (006.182.01).
- Ruční sprcha, proti usaz. vod. kamene (202.639.01).
- Flexi hadice SATIN (91.34.609.15).



91.30.190

Cr | 202.180.80 |

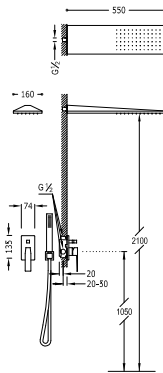

Kit doccia ad incasso

Con chiusura e regolazione di portata.

- Corpo incassato incluso
- Doccia acciaio inossidabile da parete 160x550 mm. (299.903.03).
- Supporto per doccia (006.182.01).
- Doccetta anticalcare (202.639.01).
- Flessibile satin (91.34.609.15).

Concealed shower set

with water shut off and flow control.

- Built-in body included
- Stainless steel wall shower 160x550 mm. (299.903.03).
- Elbow wall (006.182.01).
- Antilime hand shower (202.639.01).
- Satin hose (91.34.609.15).

Podomítkový jednopákový sprchový set

s uzávěrem a regulací průtoku.

- Včetně podomítkového tělesa
- Nástěnné sprchové křepitko z nerez. oceli 160x550 mm. (299.903.03).
- Držák s nástěnným přívodem vody (006.182.01).
- Ruční sprcha, proti usaz. vod. kamene (202.639.01).
- Flexi hadice SATIN (91.34.609.15).



91.30.190

Cr | 202.180.03 |

Ac | 202.180.03.AC |

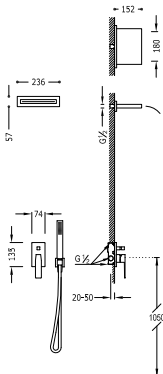

Kit doccia ad incasso

Con chiusura e regolazione di portata.

- Corpo incassato incluso
- Doccia acciaio inossidabile con cascata da 152x200 mm.
- Supporto per doccia (006.182.01).
- Doccetta anticalcare (202.639.01).
- Flessibile satin (91.34.609.15).

Concealed shower set

with water shut off and flow control.

- Built-in body included
- Stainless steel shower with cascade 152x200 mm.
- Elbow wall (006.182.01).
- Antilime hand shower (202.639.01).
- Satin hose (91.34.609.15).

Podomítkový jednopákový sprchový set

s uzávěrem a regulací průtoku.

- Včetně podomítkového tělesa
- Sprcha z nerez. oceli s kaskádou 152x200 mm.
- Držák s nástěnným přívodem vody (006.182.01).
- Ruční sprcha, proti usaz. vod. kamene (202.639.01).
- Flexi hadice SATIN (91.34.609.15).



91.30.190

Cr | 202.180.05 |

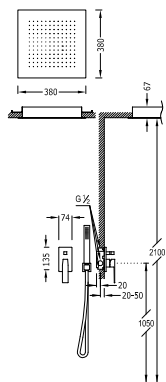

**Kit doccia ad incasso**

Con chiusura e regolazione di portata.

- Corpo incassato incluso
- Soffione doccia acciaio inossidabile 380x380 mm. (1.34.944).
- Supporto per doccia (006.182.01).
- Doccetta anticalcare (202.639.01).
- Flessibile satin (91.34.609.15).

Concealed shower set

with water shut off and flow control.

- Built-in body included
- Steel shower head 380x380 mm. (1.34.944).
- Elbow wall (006.182.01).
- Antilime hand shower (202.639.01).
- Satin hose (91.34.609.15).

Podomítkový jednopákový sprchový set

s uzávěrem a regulací průtoku.

- Včetně podomítkového tělesa
- Sprchové křepítko z nerez. oceli 380x380 mm. (1.34.944).
- Držák s nástěnným přívodem vody (006.182.01).
- Ruční sprcha, proti usaz. vod. kamene (202.639.01).
- Flexi hadice SATIN (91.34.609.15).



91.30.190

Cr 202.980.01

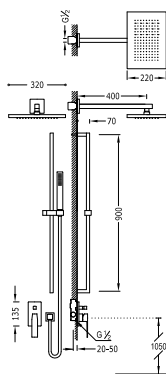
**Kit doccia ad incasso**

Con chiusura e regolazione di portata.

- Corpo incassato incluso
- Doccia fissa 320x220 mm. con snodo. Ottone (299.632.02).
- Asta anticivolo lunga 900 mm. (1.34.520).
- Presa a parete (006.182.01).
- Doccetta anticalcare (202.639.01).
- Flessibile satin (91.34.609.15).

Concealed shower set

with water shut off and flow control.

- Built-in body included
- Fixed shower head 320x220 mm. with ball joint. Brass (299.632.02).
- Sliding bar long. 900 mm. (1.34.520).
- Elbow wall (006.182.01).
- Antilime hand shower (202.639.01).
- Satin hose (91.34.609.15).

Podomítkový jednopákový sprchový set

s uzávěrem a regulací průtoku.

- Včetně podomítkového tělesa
- Pevná sprcha 320x220 mm. s kloubem. Materiál mosaz (299.632.02).
- Posuvná tyč 900 mm (1.34.520).
- Kolínko nást. Přívodem (006.182.01).
- Ruční sprcha, proti usaz. vod. kamene (202.639.01).
- Flexi hadice SATIN (91.34.609.15).



91.30.190

Cr 202.180.07

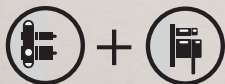

Come sempre, vi è un'unica referenza per la parte incassata e la parte a vista, pronte per essere installate.

As always, a single reference includes both the built-in and the exposed parts, ready for installation.

Obě části výrobku k instalaci, podomítková i vrchní viditelná, mají jako vždy stejné referenční číslo.



Monocomando bordo vasca
 con doccetta anticalcare.
 - Portata: 3 bar – 13 l/m.
 - NOTA: vedere lunghezza canna.

Bath-shower single lever tap for bracket shelf
 with shower antilime.
 - Flowrate: 3 bar – 13 l/m.
 - NOTE: see pipe length

Jednopávková stojánková baterie
 Sprcha, proti usaz. vod. kamene.
 - Průtok: 3 bar – 13 l/m
 - POZNÁMKA: viz délka ramínka

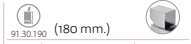
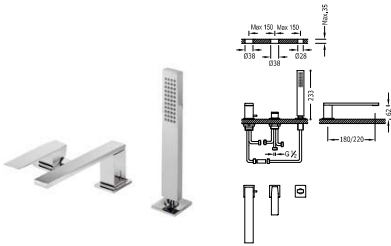

Monocomando bordo vasca
 Con bocca a cascata, doccetta anticalcare (202.639.01).
 - Portata: 3 bar – 13 l/m.
 - Compatibile con il kit serbatoio cod: 202.245.01.

Bath-shower single lever tap for bracket shelf
 with cascade cast spout and antilime hand shower (202.639.01).
 - Flowrate: 3 bar – 13 l/m.
 - Compatible with tank kit ref: 202.245.01.

Jednopávková vanová stojánková baterie
 s ramínkem kaskádou. Sprcha, proti usaz. vod. amene (202.639.01).
 - Průtok: 3 bar – 13 l/m
 - Kompatibilní se sadou nádrže ref. č.: 202.245.01.

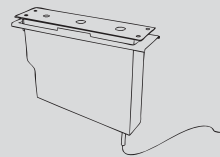
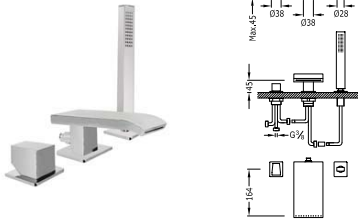
KIT BORDO VASCA

Facile montaggio superiore. Senza registro. Brevettato ®

BATH-SHOWER KIT CISTERN

Easy upper assembly, without installation. Patented ®

SADA NÁDRŽE PRO STOJÁNKOVÉ VANOVÉ BATERIE

Snadná montáž shora. Bez otvorů. Patentovaný ®

290

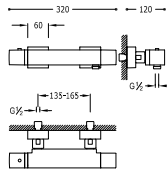

Doccia termostatica
 Doccetta anticalcare (202.639.01) con supporto orientabile.
 Flessibile satin (91.34.609.15).

Wall thermostatic shower mixer
 Anti-limescale hand shower (202.639.01) with directable support.
 Shower hose satin (91.34.609.15).

Termostatická sprchová baterie
 Ruční sprcha (202.639.01) s nastavitelným držákem, proti usaz. vod. kamene.
 Flexi hadice SATIN (91.34.609.15).



91.06.161.10

Cr 202.164.09

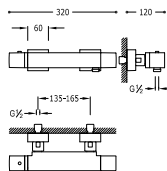

Doccia termostatica
 Doccetta anticalcare con supporto orientabile. Flessibile satin
 (91.34.609.15).

Wall thermostatic shower mixer
 Anti-limescale hand shower with directable support. Shower hose
 satin (91.34.609.15).

Termostatická sprchová baterie
 Ruční sprcha s nastavitelným držákem, proti usaz. vod. kamene.
 Flexi hadice SATIN (91.34.609.15).



91.06.161.10

Ac 202.164.09.AC
 202.164.09.NE
 202.164.09.BL

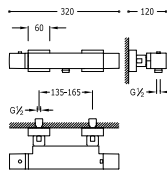

Vasca-Doccia termostatica
 Con bocca a cascata. Doccetta anticalcare (202.639.01) con
 supporto orientabile. Flessibile satin (91.34.609).

Wall thermostatic bath and shower mixer
 with cascade. Anti-limescale hand shower (202.639.01) with
 directable support. Shower hose satin (91.34.609).

Termostatická baterie pro vanu a sprchu
 s kaskádou. Ruční sprcha (202.639.01) s nastavitelným držákem,
 proti usaz. vod. kamene. Flexi hadice SATIN (91.34.609)



91.06.161.10

Cr 202.174.09

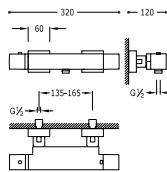

Vasca-Doccia termostatica
 Con bocca a cascata. Doccetta anticalcare con supporto orientabile.
 Flessibile satin (91.34.609).

Wall thermostatic bath and shower mixer
 with cascade. Anti-limescale hand shower with directable support.
 Shower hose satin (91.34.609).

Termostatická baterie pro vanu a sprchu
 s kaskádou. Ruční sprcha s nastavitelným držákem, proti usaz. vod.
 kamene. Flexi hadice SATIN (91.34.609)



91.06.161.10

Ac 202.174.09.AC
 202.174.09.NE
 202.174.09.BL

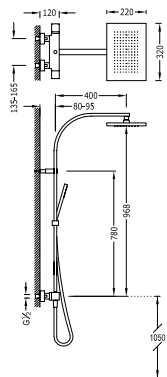

Set doccia termostatica
 - Doccia fissa 320x220 mm. con snodo. Ottone (299.632.02).
 - Doccetta anticalcare (202.639.01).
 - Flessibile satin (91.34.609.15).
 - Invertitore integrato nel regolatore di portata.

Wall thermostatic shower mixer
 - Fixed shower head 320x220 mm. with ball joint. Brass
 (299.632.02).
 - Antilime hand shower (202.639.01).
 - Satin hose (91.34.609.15).
 - Diverter integrated in the flow control.

Souprava termostatické sprchové baterie
 - Pevná sprcha 320x220 mm. s kloubem. Materiál mosaz
 (299.632.02).
 - Ruční sprcha, proti usaz. vod. kamene (202.639.01).
 - Flexi hadice SATIN (91.34.609.15).
 - Přepínač zabudovaný v regulaci průtoku



91.06.161.10

Cr 202.195.01

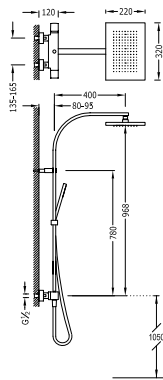

Set doccia termostatica

- Doccia fissa 320x220 mm. con snodo. Ottone.
- Doccetta anticalcare.
- Flessibile satin (91.34.609.15).
- Invertitore integrato nel regolatore di portata.

Wall thermostatic shower mixer

- Fixed shower head 320x220 mm. with ball joint. Brass.
- Antilime hand shower.
- Satin hose (91.34.609.15).
- Diverter integrated in the flow control.

Souprava termostatické sprchové baterie

- Pevná sprcha 320x220 mm. s kloubem. Materiál mosaz.
- Ruční sprcha, proti usaz. vod. kamene.
- Flexi hadice SATIN (91.34.609.15).
- Přepínač zabudovaný v regulaci průtoku.



91.06.161.16

202.195.01.NE

202.195.01.BL



Set doccia termostatica

- Doccia fissa 320x220 mm. con snodo. Ottone (299.632.02).
- Doccetta anticalcare (202.639.01).
- Flessibile satin (91.34.609.15).

Wall thermostatic shower mixer

- Fixed shower head 320x220 mm. with ball joint. Brass (299.632.02).
- Antilime hand shower (202.639.01).
- Satin hose (91.34.609.15).

Souprava termostatické sprchové baterie

- Pevná sprcha 320x220 mm. s kloubem. Materiál mosaz (299.632.02).
- Ruční sprcha, proti usaz. vod. kamene (202.639.01).
- Flexi hadice SATIN (91.34.609.15).

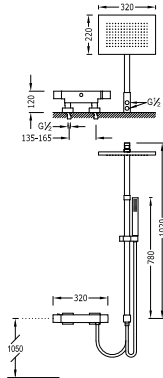

91.06.161.10

Cr | 202.385.01



Idrodoccia termostatica

- Doccia fissa 320x220 mm. con snodo. Ottone (299.632.02).
- Doccetta anticalcare (202.639.01).
- Flessibile satin (91.34.609).
- Asta telescopica.

Wall thermostatic bath mixer

- Fixed shower head 320x220 mm. with ball joint. Brass (299.632.02).
- Antilime hand shower (202.639.01).
- Satin hose (91.34.609).
- Telescopic bar.

Souprava termostatické baterie pro vanu-sprchu

- Pevná sprcha 320x220 mm. s kloubem. Materiál mosaz (299.632.02).
- Ruční sprcha, proti usaz. vod. kamene (202.639.01).
- Flexi hadice SATIN (91.34.609).
- Teleskopická tyč.

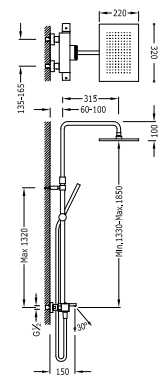

299.312.01

Cr | 202.312.01

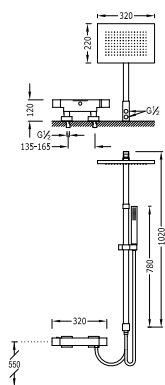

**Iidrodoccia termostatica**

- Doccia fissa 320x220 mm. con snodo. Ottone (299.632.02).
- Doccetta anticalcare (202.639.01).
- Flessibile satin (91.34.609.15).

Wall thermostatic bath mixer

- Fixed shower head 320x220 mm. with ball joint. Brass (299.632.02).
- Antilime hand shower (202.639.01).
- Satin hose (91.34.609.15).

Souprava termostatické baterie pro vanu-sprchu

- Pevná sprcha 320x220 mm. s kloubem. Materiál mosaz (299.632.02).
- Ruční sprcha, proti usaz. vod. kamene (202.639.01).
- Flexi hadice SATIN (91.34.609.15).

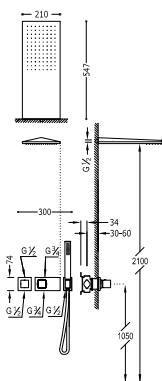

Cr 202.385.02

TERMOSTATICA AD INCASSO / CONCEALED THERMOSTATIC MIXER / PODOMÍTKOVÁ TERMOSTATICKÁ BATERIE**Kit doccia termostatica ad incasso BLOCK SYSTEM**

- Con chiusura e regolazione di portata (2 vie).
- Corpo incassato termostatico incluso.
- Doccia acciaio inossidabile da parete 210x550 mm. (299.903.02).
- Doccetta anticalcare (202.639.01).
- Flessibile satin (91.34.609.15).

Concealed thermostatic shower kit BLOCK SYSTEM

- with water shut off and flow control (2 ways).
- Built-in thermostatic body included.
- Stainless steel wall shower 210x550 mm. (299.903.02).
- Antilime hand shower (202.639.01).
- Shower hose SATIN (91.34.609.15).

Termostatický podomítkový sprchový set BLOCK SYSTEM

- s uzávěrem a regulací průtoku (2-cestná).
- Včetně podomítkového termostatického tělesa.
- Nástěnné sprchové křepitko z nerez. oceli 210x550 mm. (299.903.02).
- Ruční sprcha, proti usaz. vod. kamene (202.639.01).
- Flexi hadice SATIN (91.34.609.15).



Cr 207.252.02



Kit doccia termostatica ad incasso BLOCK SYSTEM

- Con chiusura e regolazione di portata (2 vie).
- Corpo incassato termostatico incluso
- Doccia acciaio inossidabile da parete 210x550 mm.
- Doccetta anticalcare.
- Flexibile satin (91.34.609.15).

Concealed thermostatic shower kit BLOCK SYSTEM

- with water shut off and flow control (2 ways).
- Built-in thermostatic body included
- Stainless steel wall shower 210x550 mm.
- Antilime hand shower.
- Satin hose (91.34.609.15).

Termostatický podomítkový sprchový set BLOCK SYSTEM

- s uzávěrem a regulací průtoku (2-cestná).
- Včetně podomítkového termostatického tělesa
- Nástěnné sprchové křepitko z nerez. oceli 210x550 mm.
- Ruční sprcha, proti usaz. vod. kamene.
- Flexi hadice SATIN (91.34.609.15).

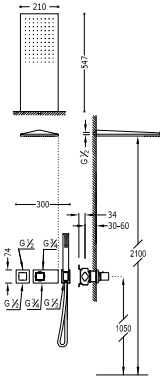

Ac	299.250.45.AC
■	299.250.45.NE
■	299.250.45.BL

Ac	207.252.02.AC
■	207.252.02.NE
■	207.252.02.BL



TERMOSTATICA ELETTRONICA AD INCASSO / BUILT-IN ELECTRONIC THERMOSTATIC / PODOMÍTKOVÁ TERMOSTATICKÁ ELEKTRONICKÁ



Kit elettronico per doccia termostatica da incasso SHOWER TECHNOLOGY

- Centralina termostatica elettronica inclusa (2 vie).
- Doccia acciaio inossidabile da parete 210x550 mm. (299.903.02).
- Supporto per doccia (207.182.01).
- Doccetta anticalcare (202.639.01).
- Flexibile satin (91.34.609.15).

Built-in electronic thermostatic shower kit SHOWER TECHNOLOGY

- Electronic thermostatic control box included (2 ways).
- Stainless steel wall shower 210x550 mm. (299.903.02).
- Elbow wall (207.182.01).
- Antilime hand shower (202.639.01).
- Shower hose SATIN (91.34.609.15).

Termostatický podomítkový elektronický sprchový set SHOWER TECHNOLOGY

- Zabudovaná termostatická elektronická kontrolní jednotka (2-cestná).
- Nástěnné sprchové křepitko z nerez. oceli 210x550 mm. (299.903.02).
- Držák s nástěnným přívodem vody (207.182.01).
- Ruční sprcha, proti usaz. vod. kamene (202.639.01).
- Flexi hadice SATIN (91.34.609.15).

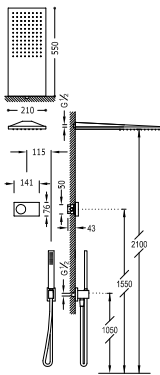

Cr	092.865.51
----	------------







CUADRO EXCLUSIVE



Lavabi
Basin mixer taps
Koupelnová baterie



Bidet
Bidets
Bidety



Monocomando esterno
Bathtub mixer taps
Jednopákový mechanismus vany



Monocomando ad incasso
Built-in sets
Vestavné soupravy



Bordovasca
Deck-mounted bathtubs
Vany s prodlouženým pultem



Termostatica esterna
Thermostatically-controlled
Termostatické



Termostatica ad incasso
Concealed thermostatic mixer
Podomítková termostatická baterie



Accessori
Accessories
Vybavení

www.tresgriferia.com



RICAMBI SU
SPARE PARTS AT
NÁHRADNÍ DÍLY NA
www.tresgriferia.com





Monocomando lavabo

con bocca a cascata. **NOTA:** La rubinetteria con canna a cascata è accompagnata da 2 rubinetti di regolazione con filtro (Ref: 91.34.525)

Single lever washbasin mixer

with cascade cast spout. **NOTE:** Taps with a cascade spout come with 2 regulation valves and a filter (Nr.: 91.34.525)

Jednopáková umyvadlová baterie

ramínko s kaskádou. **POZNÁMKA:** Baterie typu vodopádu je doplněna dvěma regulačními kohouty s filtrem (Kód: 91.34.525)

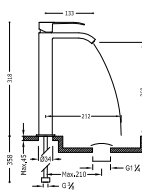
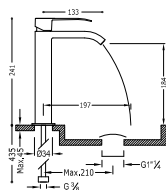
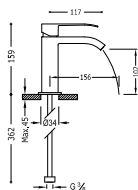

299.190.01		
Ac	006.101.01.ACD	
	006.101.01.NED	
	006.101.01.BLD	

299.190.01		
Ac	006.610.01.ACD	
	006.610.01.NED	
	006.610.01.BLD	

299.190.01		
Ac	006.810.01.ACD	
	006.810.01.NED	
	006.810.01.BLD	



Monocomando lavabo
con bocca a cascata aperta. NOTA: La rubinetteria con canna a cascata è accompagnata da 2 rubinetti di regolazione con filtro (Ref: 91.34.525)

Single lever washbasin mixer
with open cascade spout. NOTE: Taps with a cascade spout come with 2 regulation valves and a filter (Nr.: 91.34.525)

Jednopláková umyvadlová baterie
ramínko s otvoreným vodopádem. POZNÁMKA: Baterie typu vodopádu je doplněna dvěma regulačními kohouty s filtrem (Kód.: 91.34.525)

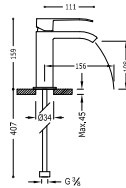
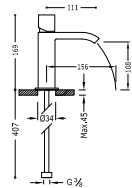

Monocomando lavabo
con bocca a cascata. NOTA: La rubinetteria con canna a cascata è accompagnata da 2 rubinetti di regolazione con filtro (Ref: 91.34.525)

Single lever washbasin mixer
with cascade cast spout. NOTE: Taps with a cascade spout come with 2 regulation valves and a filter (Nr.: 91.34.525)

Jednopláková umyvadlová baterie
ramínko s kaskádou. POZNÁMKA: Baterie typu vodopádu je doplněna dvěma regulačními kohouty s filtrem (Kód.: 91.34.525)

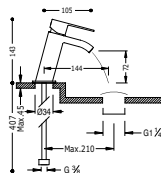

Monocomando lavabo
canna 34x10 mm.

Single lever washbasin mixer
spout 34x10 mm.

Jednopáková umyvadlová baterie
ramínko 34x10 mm

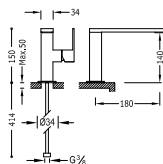

Ac 006.205.01.ACD

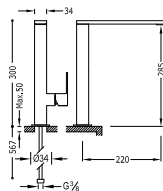

Ac 006.485.01.ACD

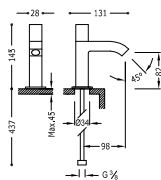

Rubinetto lavandino 1 acqua o premiscelata
1 water or premixed bathroom tap

Umyvadlová baterie pro jednu nebo předem smíchanou vodu



Ac 007.503.01.AC

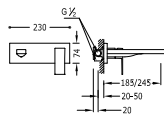

Monomando a muro

Single lever wall washbasin mixer

Jednopáková nástěnná baterie



Ac 006.200.03.AC



Ac 006.200.04.AC

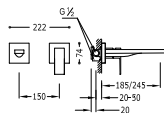

Monomando a muro

Single lever wall washbasin mixer

Jednopáková nástěnná baterie



Ac 006.200.12.AC



Ac 006.200.11.AC



Monocomando lavabo a mensola
canna 22x22 mm.

Deck-mounted washbasin mixer tap
spout 22x22 mm.

Páková baterie k umyvadlu
ramínko 22x22 mm

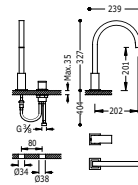

Ac | 006.105.03.AC

Doppio comando a mensola
canna 22x22 mm.

Counter-top dual control tap
spout 22x22 mm.

Kohoutková stojánková vanová baterie
ramínko 22x22 mm

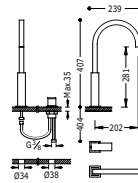

Ac | 006.105.04.AC

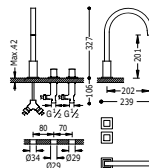

Ac | 008.105.03.AC

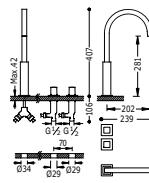

Ac | 008.105.04.AC

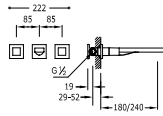

Monoblocco a muro
Single hole wall mixer
Nástěnná umyvadlová baterie

91.34.282 (180 mm.)
Ac **008.153.01.AC**

91.34.282 (240 mm.)
Ac **008.154.01.AC**

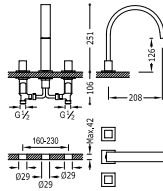

Doppio comando a mensola
Canna tubo 35x15 mm. Aeratore rettangolare
Counter-top dual control tap
Tube spout 35x15 mm. Rectangular Aerator

Kohoutková stojánková vanová baterie
ramínko 35x15 mm se skrytým obdélníkovým perlátorem

91.34.283
Ac **008.105.01.AC**

BIDET / BIDETS / BIDETY

Monocomando bidet
Single lever bidet mixer
Jednopáková bidetová baterie

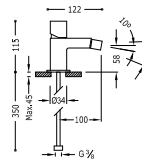

91.30.190
Ac **007.120.01.ACD**
007.120.01.NE.D
007.120.01.BLD

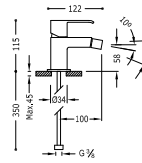

91.30.190
Ac **006.120.01.ACD**
006.120.01.NE.D
006.120.01.BLD



SIMPLE-RAPID

Valvola con blocco superiore
Valve with upper blockage
Ventil s vrchním blokáváním

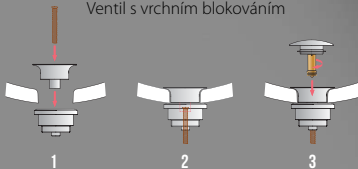

CLICK-CLACK



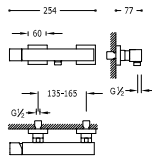

Monocomando doccia
Doccetta anticalcare con supporto orientabile. Flessibile satin
(91.34.609.15).

Single lever shower mixer
Anti-limescale hand shower with directable support. Shower hose satin (91.34.609.15).

Jednopáková sprchová baterie
Ruční sprcha s nastavitelným držákem, proti usaz. vod. kamene.
Flexi hadice SATIN (91.34.609.15).



Ac	5.07.167.03	
	6.07.167	
	4.07.167	

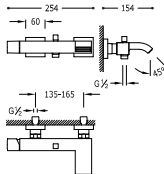

Monocomando vasca
Con bocca a cascata. Doccetta anticalcare con supporto orientabile.
Flessibile satin (91.34.609).

Single lever bath and shower mixer
with cascade. Anti-limescale hand shower with directable support.
Shower hose satin (91.34.609).

Jednopáková baterie pro vanu-sprchu
s kaskádou. Ruční sprcha s nastavitelným držákem, proti usaz. vod.
kamene. Flexi hadice SATIN (91.34.609).



Ac	5.07.170.02.03	
	6.07.170.02	
	4.07.170.02	

GRUPPI AD INCASSO / BUILT-IN SETS / VESTAVĚNÉ SOUPRAVY

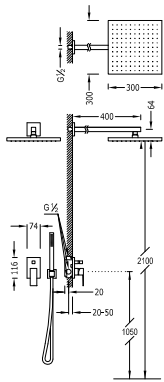

Kit doccia ad incasso
Con chiusura e regolazione di portata.
- Corpo incassato incluso.
- Doccia fissa 300x300 mm. con snodo. Ottone.
- Supporto per doccia.
- Doccetta anticalcare.
- Flessibile satin (91.34.609.15).

Concealed shower set
with water shut off and flow control.
- Built-in body included
- Fixed shower head 300x300 mm. with ball joint. Brass.
- Elbow wall.
- Antilime hand shower.
- Satin hose (91.34.609.15).

Podomítkový jednopákový sprchový set
s uzávěrem a regulací průtoku.
- Včetně podomítkového tělesa
- Pevná sprcha 300x300 mm. s kloubem. Materiál mosaz.
- Držák s nástěnným přívodem vody.
- Ruční sprcha, proti usaz. vod. kamene.
- Flexi hadice SATIN (91.34.609.15).



	6.06.980	
	4.06.980	

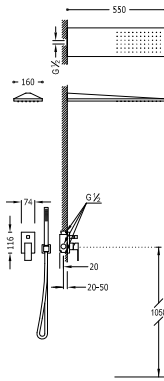

Kit doccia ad incasso
Con chiusura e regolazione di portata.
- Corpo incassato incluso
- Doccia acciaio inossidabile da parete 160x550 mm.
- Supporto per doccia.
- Doccetta anticalcare.
- Flessibile satin (91.34.609.15).

Concealed shower set
with water shut off and flow control.
- Built-in body included
- Stainless steel wall shower 160x550 mm.
- Elbow wall.
- Antilime hand shower.
- Satin hose (91.34.609.15).

Podomítkový jednopákový sprchový set
s uzávěrem a regulací průtoku.
- Včetně podomítkového tělesa
- Nástěnné sprchové křepitko z nerez. oceli 160x550 mm
- Držák s nástěnným přívodem vody.
- Ruční sprcha, proti usaz. vod. kamene
- Flexi hadice SATIN (91.34.609.15).



Ac	006.180.03.AC	
----	---------------	--

BORDOVASCA / DECK-MOUNTED BATHTUBS / VANY S PRODLOUŽENÝM PULTEM

Ref. / Nr. / Kód:

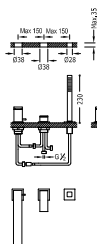

Monocomando bordo vasca
con doccetta anticalcare (006.639.01.AC).
· Portata: 3 bar – 13 l/m.
· NOTA: vedere lunghezza canna.

Bath-shower single lever tap for bracket shelf
with shower antilime (006.639.01.AC).
· Flowrate: 3 bar – 13 l/m.
· NOTE: see pipe length

Jednopáková vanová stojánková baterie
Sprcha, proti usaz. vod. kamene (006.639.01.AC).
· Průtok: 3 bar – 13 l/m.
· POZNÁMKA: viz délka ramínka

	91.30.150 (180 mm.)	
Ac	006.161.05.AC	
	91.30.150 (220 mm.)	
Ac	006.161.03.AC	

TERMOSTATICHE / THERMOSTATICALLY-CONTROLLED / TERMOSTATICKÉ

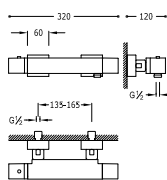

Doccetta termostatica
Doccetta anticalcare con supporto orientabile. Flessibile satin (91.34.609.15).

Wall thermostatic shower mixer
Anti-limescale hand shower with directable support. Shower hose satin (91.34.609.15).

Termostatická sprchová baterie
Ruční sprcha s nastavitelným držákem, proti usaz. vod. kamene. Flexi hadice SATIN (91.34.609.15).

	91.06.161.53					
Ac	5.07.164.03.9					
	91.06.161.16 = 91.06.161.14					
	6.07.164.9					
	4.07.164.9					

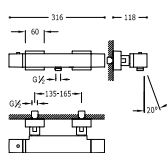

Vasca-Doccia termostatica
Con bocca a cascata. Doccetta anticalcare con supporto orientabile. Flessibile satin (91.34.609).

Wall thermostatic bath and shower mixer
with cascade. Anti-limescale hand shower with directable support. Shower hose satin (91.34.609).

Termostatická baterie pro vanu a sprchu
s kaskádou. Ruční sprcha s nastavitelným držákem, proti usaz. vod. kamene. Flexi hadice SATIN (91.34.609)

	91.06.161.53	
Ac	5.07.174.03.9	
	91.06.161.16 = 91.06.161.14	
	6.07.174.9	
	4.07.174.9	

TRES TOUCH COOL

Sistema antiscottatura
Scald security system
Bezpečnostní systém chránící před opažením

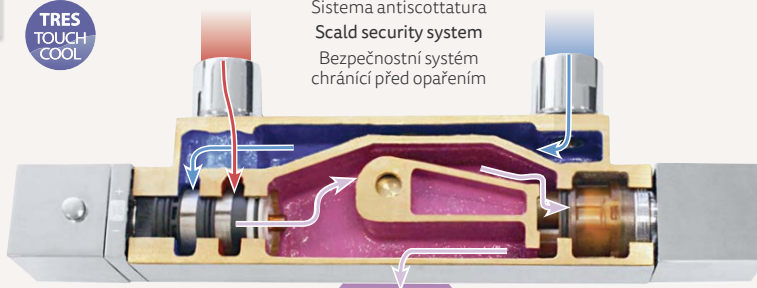

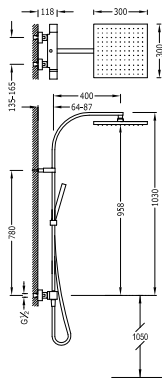

Set doccia termostatica

- Doccia fissa 300x300 mm. Ottone.
- Doccetta anticalcare.
- Flessibile satin (91.34.609.15).
- Invertitore integrato nel regolatore di portata.

Wall thermostatic shower mixer

- Fixed shower head 300x300 mm. Brass.
- Antilime hand shower.
- Satin hose (91.34.609.15).
- Diverter integrated in the flow control.

Souprava termostatické sprchové baterie

- Pevná sprcha 300x300 mm. Materiál mosaz.
- Ruční sprcha, proti usaz. vod. kamene.
- Flexi hadice SATIN (91.34.609.15).
- Přepínač zabudovaný v regulaci průtoku.



■ 91.06.161.16	REGOLAZIONE
■ 91.06.161.14	
■ 6.07.395	
■ 4.07.395	

TERMOSTATICA AD INCASSO / CONCEALED THERMOSTATIC MIXER / PODOMÍTKOVÁ TERMOSTATICKÁ BATERIE

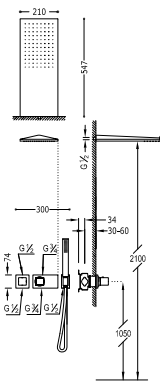

Kit doccia termostatica ad incasso BLOCK SYSTEM

- Con chiusura e regolazione di portata (2 vie).
- Corpo incassato termostatico incluso
- Soffione doccia acciaio inossidabile 210x550 mm.
- Doccetta anticalcare.
- Flessibile satin (91.34.609.15).

Concealed thermostatic shower kit BLOCK SYSTEM

- with water shut off and flow control (2 ways).
- Built-in thermostatic body included
- Stainless steel wall shower 210x550 mm.
- Antilime hand shower.
- Satin hose (91.34.609.15).

Termostatický podomítkový sprchový set BLOCK SYSTEM

- s uzávěrem a regulací průtoku (2-cestná).
- Včetně podomítkového termostatického tělesa
- Sprchové křepitko z nerez. oceli 210x550 mm.
- Ruční sprcha, proti usaz. vod. kamene.
- Flexi hadice SATIN (91.34.609.15).

■ Ac	299.250.45.AC
■	299.250.45.NE
■	299.250.45.BL

Ac	207.252.02.AC
■	207.252.02.NE
■	207.252.02.BL





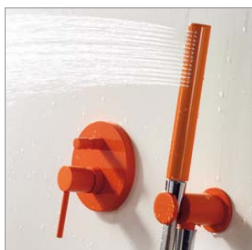
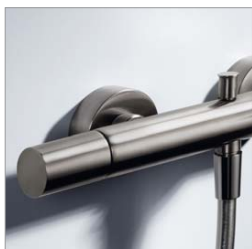

STUDY EXCLUSIVE



Lavabi
Basin mixer taps
Koupelňová baterie



Bidet
Bidets
Bidety



Monocomando esterno
Bathtub mixer taps
Jednopákový mechanismus vany



Monocomando ad incasso
Built-in sets
Vestavné soupravy



Bordovasca
Deck-mounted bathtubs
Vany s prodlouženým pultem



Termostatica esterna
Thermostatically-controlled
Termostatické



Termostatica ad incasso
Concealed thermostatic mixer
Podomítková termostatická baterie



Termostatica elettronica ad incasso
Built-in electronic thermostatic
Podomítková termostatická elektronická



Accessori
Accessories
Vybavení



RICAMBI SU
SPARE PARTS AT
NÁHRADNÍ DÍLY NA
www.tresgriferia.com

www.tresgriferia.com





Monocomando lavabo
 Single lever washbasin mixer
 Jednopáková umyvadlová baterie

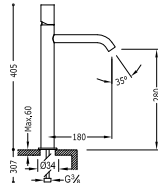
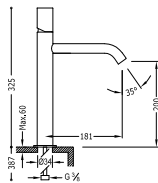
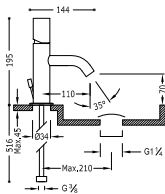

91.07.190.05

Cr | 261.903.01



91.07.190.05

Cr | 261.903.01.D



91.07.190.05

Cr | 261.307.01



91.07.190.05

Cr | 261.308.01



Monocomando lavabo
Single lever washbasin mixer
Jednopláková umyvadlová baterie

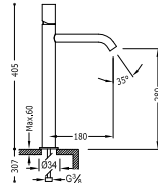
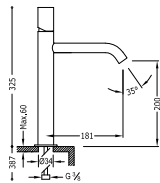
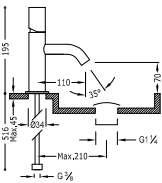

91.07.190.05	
Ac	261.903.01.ACD
Bi-Mt	261.903.01.BM.D
	261.903.01.TAM.D
	261.903.01.TNA.D
	261.903.01.TRO.D
	261.903.01.TVI.D
	261.903.01.TFU.D
	261.903.01.TVE.D
	261.903.01.TNE.D
	261.903.01.TBLD

91.07.190.05	
Ac	261.307.01.ACD
Bi-Mt	261.307.01.BM.D
	261.307.01.TAM.D
	261.307.01.TNA.D
	261.307.01.TRO.D
	261.307.01.TVI.D
	261.307.01.TFU.D
	261.307.01.TVE.D
	261.307.01.TNE.D
	261.307.01.TBLD

91.07.190.05	
Ac	261.308.01.ACD
Bi-Mt	261.308.01.BM.D
	261.308.01.TAM.D
	261.308.01.TNA.D
	261.308.01.TRO.D
	261.308.01.TVI.D
	261.308.01.TFU.D
	261.308.01.TVE.D
	261.308.01.TNE.D
	261.308.01.TBLD

Monocomando lavabo
 Single lever washbasin mixer
 Jednopláková umyvadlová baterie

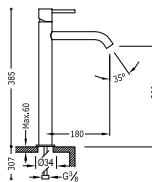
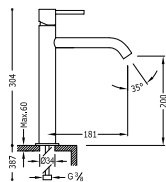
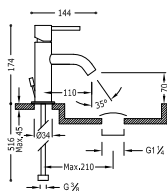

91.07.190.05

Cr | 262.903.01



91.07.190.05

Cr | 262.903.01.D



91.07.190.05

Cr | 262.307.01



91.07.190.05

Cr | 262.308.01



Monocomando lavabo
Single lever washbasin mixer
Jednopláková umyvadlová baterie

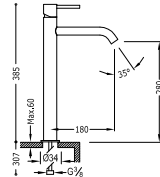
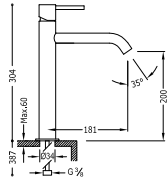
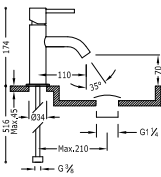

91.07.190.05

Ac	262.903.01.AC.D	
Bl-Mt	262.903.01.BM.D	N
	262.903.01.TAM.D	
	262.903.01.TNA.D	
	262.903.01.TRO.D	
	262.903.01.TVLD	
	262.903.01.TFUD	
	262.903.01.TVED	
	262.903.01.TNED	
	262.903.01.TBLD	



91.07.190.05

Ac	262.307.01.AC.D	
Bl-Mt	262.307.01.BM.D	N
	262.307.01.TAM.D	
	262.307.01.TNA.D	
	262.307.01.TRO.D	
	262.307.01.TVLD	
	262.307.01.TFUD	
	262.307.01.TVED	
	262.307.01.TNED	
	262.307.01.TBLD	



91.07.190.05

Ac	262.308.01.AC.D	
Bl-Mt	262.308.01.BM.D	N
	262.308.01.TAM.D	
	262.308.01.TNA.D	
	262.308.01.TRO.D	
	262.308.01.TVLD	
	262.308.01.TFUD	
	262.308.01.TVED	
	262.308.01.TNED	
	262.308.01.TBLD	

Monocomando lavabo
Single lever washbasin mixer
Jednpkov umyvdlov baterie

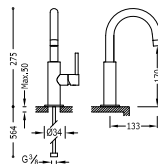

Cr 262.904.03

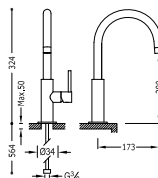

Cr 262.904.02

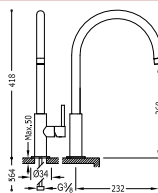

Cr 262.904.01

Monocomando lavabo
Single lever washbasin mixer
Jednpkov umyvdlov baterie

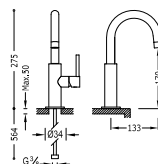

- Ac 262.904.03.AC.D
- BI-Mt 262.904.03.BM.D
- 262.904.03.TAM.D
- 262.904.03.TNA.D
- 262.904.03.TRO.D
- 262.904.03.TVI.D
- 262.904.03.TFU.D
- 262.904.03.TVE.D
- 262.904.03.TNE.D
- 262.904.03.TBL.D

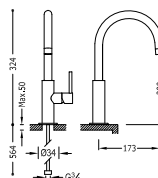

- Ac 262.904.02.AC.D
- BI-Mt 262.904.02.BM.D
- 262.904.02.TAM.D
- 262.904.02.TNA.D
- 262.904.02.TRO.D
- 262.904.02.TVI.D
- 262.904.02.TFU.D
- 262.904.02.TVE.D
- 262.904.02.TNE.D
- 262.904.02.TBL.D

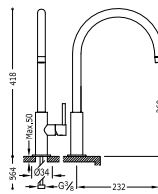

- Ac 262.904.01.AC.D
- BI-Mt 262.904.01.BM.D
- 262.904.01.TAM.D
- 262.904.01.TNA.D
- 262.904.01.TRO.D
- 262.904.01.TVI.D
- 262.904.01.TFU.D
- 262.904.01.TVE.D
- 262.904.01.TNE.D
- 262.904.01.TBL.D

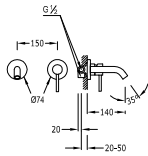

Monomando a muro
Single lever wall washbasin mixer
Jednopáková nástěnná baterie



91.30.190
Cr | 262.200.80

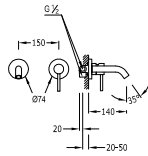

Monomando a muro
Single lever wall washbasin mixer
Jednopáková nástěnná baterie



91.30.190
Ac | 262.200.80.AC |
Bl-Mt | 262.200.80.BM | N
262.200.80.TAM |
262.200.80.TNA |
262.200.80.TRO |
262.200.80.TVI |
262.200.80.TFU |
262.200.80.TVE |
262.200.80.TNE |
262.200.80.TBL |

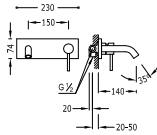

Monomando a muro
Single lever wall washbasin mixer
Jednopáková nástěnná baterie



91.30.190
Cr | 262.200.50

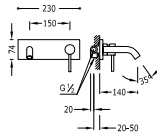

Monomando a muro
Single lever wall washbasin mixer
Jednopáková nástěnná baterie



91.30.190
Ac | 262.200.50.AC |
Bl-Mt | 262.200.50.BM | N
262.200.50.TAM |
262.200.50.TNA |
262.200.50.TRO |
262.200.50.TVI |
262.200.50.TFU |
262.200.50.TVE |
262.200.50.TNE |
262.200.50.TBL |

Monocomando lavabo a mensola
Deck-mounted washbasin mixer tap
Páková baterie k umyvadlu

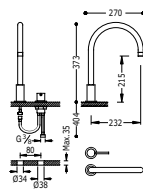

360 * 91.30.190

Cr	261.105.01
Ac	261.105.01.AC

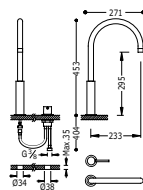

360 * 91.30.190

Cr	261.105.02
Ac	261.105.02.AC

Doppio comando a mensola
Counter-top dual control tap
Kohoutková stojánková vanová baterie

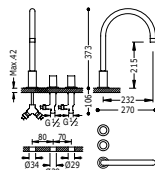

360 * 299.105.01

Cr	061.105.01
----	------------

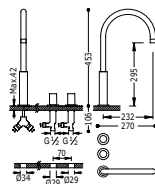

360 * 299.105.01

Cr	061.105.02
----	------------



Monocomando bidet
Single lever bidet mixer
Jednopáková bidetová baterie

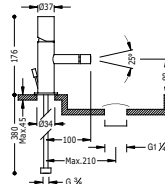

91.07.190.05

Cr | 261.120.01

91.07.190.05

Cr | 261.120.01.D

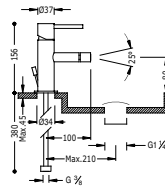

91.07.190.05

Cr | 262.120.01

91.07.190.05

Cr | 262.120.01.D

Monocomando bidet
Single lever bidet mixer
Jednopáková bidetová baterie

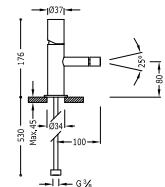

91.07.190.05

Ac | 061.120.01.ACD

BI-Mt | 061.120.01.BM.D

061.120.01.TAM.D

061.120.01.TNA.D

061.120.01.TRO.D

061.120.01.TVI.D

061.120.01.TFU.D

061.120.01.TVE.D

061.120.01.TNE.D

061.120.01.TBL.D

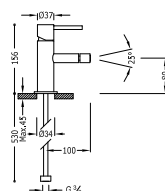

91.07.190.05

Ac | 062.120.01.ACD

BI-Mt | 062.120.01.BM.D

062.120.01.TAM.D

062.120.01.TNA.D

062.120.01.TRO.D

062.120.01.TVI.D

062.120.01.TFU.D

062.120.01.TVE.D

062.120.01.TNE.D

062.120.01.TBL.D

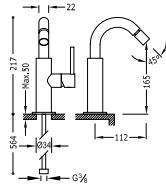

Monocomando bidet
Single lever bidet mixer
Jednopáková bidetová baterie

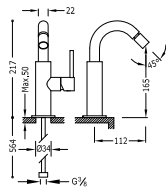

Monocomando bidet
Single lever bidet mixer
Jednopáková bidetová baterie

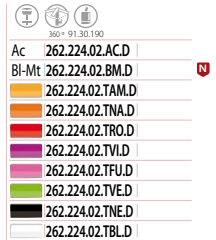

MONOCOMANDI BAGNO / BATHTUB MIXER TAPS / JEDNOPÁKOVÝ MECHANISMUS VANY

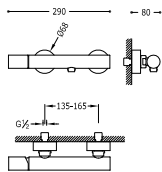

Monocomando doccia
Doccetta anticalcare (034.116.01) con supporto orientabile.
Flessibile satin (91.34.609.15).

Single lever shower mixer
Anti-limescale hand shower (034.116.01) with directable support.
Shower hose satin (91.34.609.15).

Sprchová baterie
Ruční sprcha (034.116.01) s nastavitelným držákem, proti usaz. vod. kamene a flexi hadice SATIN (91.34.609.15).

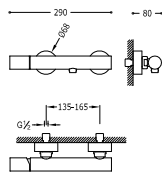

Monocomando doccia
Doccetta anticalcare con supporto orientabile. Flessibile satin (91.34.609.15).

Single lever shower mixer
Anti-limescale hand shower with directable support. Shower hose satin (91.34.609.15).

Sprchová baterie
Ruční sprcha s nastavitelným držákem, proti usaz. vod. kamene. Flexi hadice SATIN (91.34.609.15).

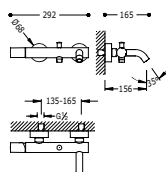

Monocomando vasca
Doccetta anticalcare con supporto orientabile. Flessibile satin (91.34.609).

Single lever bath and shower mixer
Anti-limescale hand shower with directable support. Shower hose satin (91.34.609).

Vanová baterie
Ruční sprcha s nastavitelným držákem, proti usaz. vod. kamene. Flexi hadice SATIN (91.34.609).



Monocomando vasca
Doccetta anticalcare con supporto orientabile. Flessibile satin
(91.34.609).

Single lever bath and shower mixer

Anti-limescale hand shower with directable support. Shower hose satin
(91.34.609).

Vanová baterie

Ruční sprcha s nastaviteľným držákom, proti usaz. vod. kamene.
Flexi hadice SATIN (91.34.609).

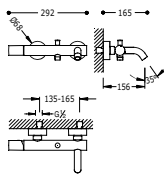

91.30.190	Ac	261.170.01.AC	
	Bl-Mt	261.170.01.BM	N
		261.170.01.BM	
		261.170.01.TAM	
		261.170.01.TNA	
		261.170.01.TRO	
		261.170.01.TVI	
		261.170.01.TFU	
		261.170.01.TVE	
		261.170.01.TNE	
		261.170.01.TBL	

GRUPPI AD INCASSO / BUILT-IN SETS / VESTAVĚNÉ SOUPRAVY

Monocomando incasso (1 via)
corpo incassato incluso

Built-in mixer taps (1 way)
Built-in body included

Vestavěná jednopáková baterie (jednocestný)
včetně podomítkového tělesa

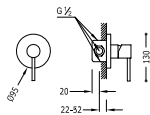

91.30.190
Cr | 262.177.90

Monocomando incasso (2 vie)
corpo incassato incluso

Built-in mixer taps (2 way)
Built-in body included

Vestavěná jednopáková baterie (dvocestný)
včetně podomítkového tělesa

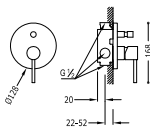

91.30.190
Cr | 262.180.90

Kit doccia ad incasso
Con chiusura e regolazione di portata.
- Corpo incassato incluso
- Supporto per doccia (205.182.01).
- Doccia anticalcare (034.116.01).
- Flessibile satin (91.34.609.15).

Concealed shower set

with water shut off and flow control.

- Built-in body included
- Elbow wall (205.182.01).
- Antilime hand shower (034.116.01).
- Satin hose (91.34.609.15).

Podomítkový jednopákový sprchový set

s uzávěrem a regulací průtoku.
- Včetně podomítkového tělesa
- Držák s nástěnným přívodem vody (205.182.01).
- Ruční sprcha, proti usaz. vod. kamene (034.116.01).
- Flexi hadice SATIN (91.34.609.15).

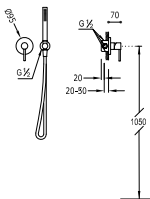

91.30.190
Cr | 262.177.92

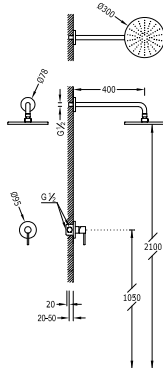
**Kit doccia ad incasso**

Con chiusura e regolazione di portata.

- Corpo incassato incluso
- Doccia fissa Ø 300 mm. con snodo. Ottone. (1.34.137.30).

Concealed shower set

with water shut off and flow control.

- Built-in body included
- Fixed shower head Ø 300 mm. with ball joint. Brass. (1.34.137.30).

Podomítkový jednopákový sprchový set

s uzávěrem a regulací průtoku.

- Včetně podomítkového tělesa
- Pevná sprcha Ø 300 mm. s kloubem. Materiál mosaz. (1.34.137.30).



91.30.190

Cr 262.177.93

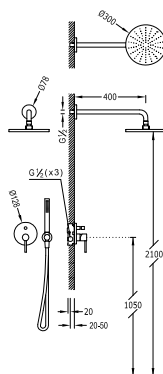
**Kit doccia ad incasso**

Con chiusura e regolazione di portata.

- Corpo incassato incluso
- Doccia fissa Ø 300 mm. con snodo. Ottone. (1.34.137.30).
- Supporto per doccia (205.182.01).
- Doccia anticalcare (034.116.01).
- Flessibile satin (91.34.609.15).

Concealed shower set

with water shut off and flow control.

- Built-in body included
- Fixed shower head Ø 300 mm. with ball joint. Brass. (1.34.137.30).
- Elbow wall (205.182.01).
- Antilime hand shower (034.116.01).
- Satin hose (91.34.609.15).

Podomítkový jednopákový sprchový set

s uzávěrem a regulací průtoku.

- Včetně podomítkového tělesa
- Pevná sprcha Ø 300 mm. s kloubem. Materiál mosaz. (1.34.137.30).
- Držák s nástěnným přívodem vody.
- Ruční sprcha, proti usaz. vod. kamene (034.116.01).
- Flexi hadice SATIN (91.34.609.15).



91.30.190

Cr 262.980.91

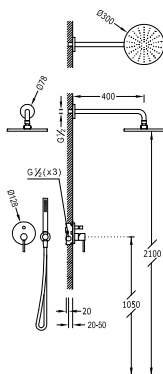
**Kit doccia ad incasso**

Con chiusura e regolazione di portata.

- Corpo incassato incluso
- Doccia fissa Ø 300 mm. con snodo. Ottone.
- Supporto per doccia.
- Doccia anticalcare.
- Flessibile satin (91.34.609.15).

Concealed shower set

with water shut off and flow control.

- Built-in body included
- Fixed shower head Ø 300 mm. with ball joint. Brass.
- Elbow wall.
- Antilime hand shower.
- Satin hose (91.34.609.15).

Podomítkový jednopákový sprchový set

s uzávěrem a regulací průtoku.

- Včetně podomítkového tělesa
- Pevná sprcha Ø 300 mm. s kloubem. Materiál mosaz.
- Držák s nástěnným přívodem vody.
- Ruční sprcha, proti usaz. vod. kamene.
- Flexi hadice SATIN (91.34.609.15).



91.30.190

Ac 262.980.91.AC

Bl-Mt 262.980.91.BM

262.980.91.TAM

262.980.91.TNA

262.980.91.TRO

262.980.91.TVI

262.980.91.TFU

262.980.91.TVE

262.980.91.TNE

262.980.91.TBL

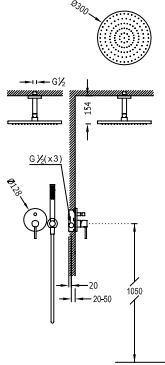

Kit doccia ad incasso

Con chiusura e regolazione di portata.

- Corpo incassato incluso
- Doccia fissa Ø 300 mm. con snodo. Ottone. (1.34.137.30).
- Supporto per doccia (205.182.01).
- Doccia anticalcare (034.116.01).
- Flessibile satin (91.34.609.15).

Concealed shower set

with water shut off and flow control.

- Built-in body included
- Fixed shower head Ø 300 mm. with ball joint. Brass. (1.34.137.30)
- Elbow wall (205.182.01).
- Antilime hand shower (034.116.01).
- Satin hose (91.34.609.15).

Podomítkový jednopákový sprchový set

s uzávěrem a regulací průtoku.

- Včetně podomítkového tělesa
- Pevná sprcha Ø 300 mm. s kloubem. Materiál mosaz. (1.34.137.30).
- Držák s nástěnným přívodem vody (205.182.01).
- Ruční sprcha, proti usaz. vod. kamene (034.116.01).
- Flexi hadice SATIN (91.34.609.15).



91.30.190

Cr | 262.180.80

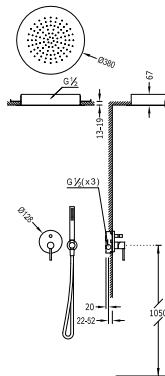

Kit doccia ad incasso

Con chiusura e regolazione di portata.

- Corpo incassato incluso
- Soffione doccia acciaio inossidabile Ø 380 mm. (1.34.940).
- Supporto per doccia (205.182.01).
- Doccia anticalcare (034.116.01).
- Flessibile satin (91.34.609.15).

Concealed shower set

with water shut off and flow control.

- Built-in body included
- Steel shower head Ø 380 mm. (1.34.940).
- Elbow wall (205.182.01).
- Antilime hand shower (034.116.01).
- Satin hose (91.34.609.15).

Podomítkový jednopákový sprchový set

s uzávěrem a regulací průtoku.

- Včetně podomítkového tělesa
- Sprchové křepítko z nerez. oceli Ø 380 mm. (1.34.940).
- Držák s nástěnným přívodem vody (205.182.01).
- Ruční sprcha, proti usaz. vod. kamene (034.116.01).
- Flexi hadice SATIN (91.34.609.15).



91.30.190

Cr | 262.180.99

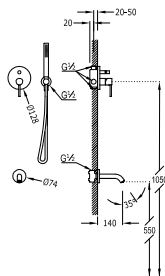

Kit doccia ad incasso

Con chiusura e regolazione di portata.

- Corpo incassato incluso.
- Canna per vasca da bagno.
- Supporto per doccia (205.182.01).
- Doccia anticalcare (034.116.01).
- Flessibile satin (91.34.609.15).

Concealed shower set

with water shut off and flow control.

- Built-in body included.
- Bath spout.
- Elbow wall (205.182.01).
- Antilime hand shower (034.116.01).
- Satin hose (91.34.609.15).

Podomítkový jednopákový sprchový set

s uzávěrem a regulací průtoku.

- Včetně podomítkového tělesa.
- Kohoutek pro vanu.
- Držák s nástěnným přívodem vody (205.182.01).
- Ruční sprcha, proti usaz. vod. kamene (034.116.01).
- Flexi hadice SATIN (91.34.609.15).



91.30.190

Cr | 262.180.03

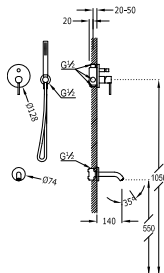

**Kit doccia ad incasso**

Con chiusura e regolazione di portata.

- Corpo incassato incluso.
- Canna per vasca da bagno.
- Supporto per doccia.
- Doccia anticalcare.
- Flessibile satin (91.34.609.15).

Concealed shower set

with water shut off and flow control.

- Built-in body included.
- Bath spout.
- Elbow wall.
- Antilime hand shower.
- Satin hose (91.34.609.15).

Podomítkový jednopákový sprchový set

s uzávierom a reguláci prútok.

- Všetchné podomítkového tělesa.
- Kohoutek pro vanu.
- Držák s nástěnným přívodem vody.
- Ruční sprcha, proti usaz. vod. kamene.
- Flexi hadice SATIN (91.34.609.15).

	91.30.190	
	Ac	262.180.03.AC
	BI-Mt	262.180.03.BM
		262.180.03.TAM
		262.180.03.TNA
		262.180.03.TRO
		262.180.03.TVI
		262.180.03.TFU
		262.180.03.TVE
		262.180.03.TNE
		262.180.03.TBL

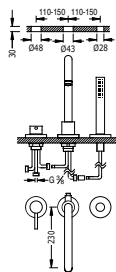
BORDOVASCA / DECK-MOUNTED BATHTUBS / VANY S PRODLOUŽENÝM PULTEM**Monocomando bordo vasca**

Doccetta anticalcare.

- Portata: 3 bar - 14 l/m.

Bath-shower single lever tap for bracket shelf

with shower antilime.

- Flowrate: 3 bar - 14 l/m.

Jednopáková stojánková vanová baterie

Sprcha, proti usaz. vod. kamene.

- Prútok: 3 bar - 14 l/m

	91.34.288	
	Cr	261.150.01
	91.34.288	
	Cr	262.150.01
	Ac	062.150.01.AC

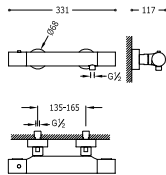
TERMOSTATICHE / THERMOSTATICALLY-CONTROLLED / TERMOSTATICKÉ**Doccia termostatica**

Doccetta anticalcare con supporto orientabile. Flessibile satin (91.34.609.15).

Wall thermostatic shower mixer

Anti-limescale hand shower with directable support and satin hose (91.34.609.15).

Termostatická sprchová baterie

Ruční sprcha s nastavitelným držákem, proti usaz. vod. kamene a flexi hadice SATIN (91.34.609.15).

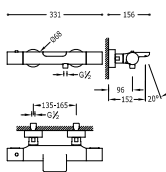

	299.195.03	
	Cr	261.162.09
	299.195.03.AC	
	Ac	261.162.09.AC

**Vasca-Doccia termostatica**

Con bocca a cascata. Doccetta anticalcare con supporto orientabile. Flessibile satin (91.34.609.15).

Wall thermostatic shower mixer

With cascade. Anti-limescale hand shower with directable support and satin hose (91.34.609.15).

Termostatická baterie pro vanu-sprchu

s kaskádou. Ruční sprcha s nastavitelným držákem, proti usaz. vod. kamene a flexi hadice SATIN (91.34.609.15).



	299.195.03	
	Cr	261.172.09
	299.195.03.AC	
	Ac	261.172.09.AC

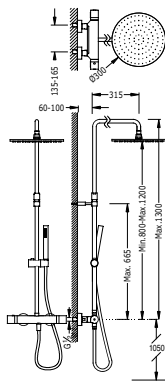

Set doccia termostatica

- Doccia fissa Ø 300 mm. con snodo. Ottone (1.34.137.30).
- Doccetta anticalcare (034.116.01).
- Flexibile satin (91.34.609.15).
- Asta telescopica.
- Invertitore integrato nel regolatore di portata.

Wall thermostatic shower mixer

- Fixed shower head Ø 300 mm. with ball joint. Brass. (1.34.137.30).
- Antilime hand shower (034.116.01).
- Satin hose (91.34.609.15).
- Telescopic bar.
- Diverter integrated in the flow control.

Souprava termostatické sprchové baterie

- Pevná sprcha Ø 300 mm. s kloubem. Materiál mosaz (1.34.137.30).
- Ruční sprcha, proti usaz. vod. kamene (034.116.01).
- Flexi hadice SATIN (91.34.609.15).
- Teleskopická tyč.
- Přepínač zabudovaný v regulaci průtoku.



299.195.03

Cr | 261.210.01

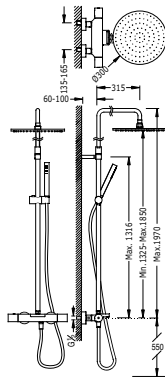

Vasca-Doccia termostatica

- Doccia fissa Ø 300 mm. con snodo. Ottone (1.34.137.30).
- Doccetta anticalcare (034.116.01).
- Flexibile satin (91.34.609).
- Asta telescopica.

Wall thermostatic shower mixer

- Fixed shower head Ø 300 mm. with ball joint. Brass. (1.34.137.30).
- Antilime hand shower (034.116.01).
- Satin hose (91.34.609).
- Telescopic bar.

Souprava termostatické baterie pro vanu-sprchu

- Pevná sprcha Ø 300 mm. s kloubem. Materiál mosaz (1.34.137.30).
- Ruční sprcha, proti usaz. vod. kamene (034.116.01).
- Flexi hadice SATIN (91.34.609).
- Teleskopická tyč.



299.195.03

Cr | 262.312.01



REGOLAZIONE ALTEZZA

Barre telescopiche, che consentono la regolazione in altezza, per una maggiore comodità durante la doccia.

HEIGHT ADJUSTMENT

Extendable shower bars enabling height adjustment and greater comfort when showering.

VÝŠKOVÁ NASTAVITELNOST

Výsuvné sprchové tyče umožňující regulovat výšku sprchy k pohodlnému sprchování.

TERMOSTATICA AD INCASSO / CONCEALED THERMOSTATIC MIXER / PODOMÍTKOVÁ TERMOSTATICKÁ BATERIE

Ref. / Nr. / Kód:



Kit doccia termostatica ad incasso BLOCK SYSTEM

- Con chiusura e regolazione di portata (2 vie).
- Corpo incassato termostatico incluso.
- Doccia fissa Ø 300 mm. con snodo. Ottone (1.34.137.30).
- Doccetta anticalcare (034.116.01).
- Flessibile satin (91.34.609.15).

Concealed thermostatic shower kit BLOCK SYSTEM
with water shut off and flow control (2 ways).

- Built-in thermostatic body included.
- Fixed shower head Ø 300 mm. with ball joint. Brass (1.34.137.30).
- Antilime hand shower (034.116.01).
- Shower hose SATIN (91.34.609.15).

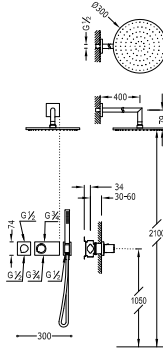
Termostatický podomítkový sprchový set BLOCK SYSTEM
s uzávěrem a regulací průtoku (2-cestná).

- Včetně podomítkového termostatického tělesa.
- Pevná sprcha Ø 300 mm. s kloubem. Materiál Mosaz (1.34.137.30).
- Ruční sprcha, proti usaz. vod. kamene (034.116.01).
- Flexi hadice SATIN (91.34.609.15).

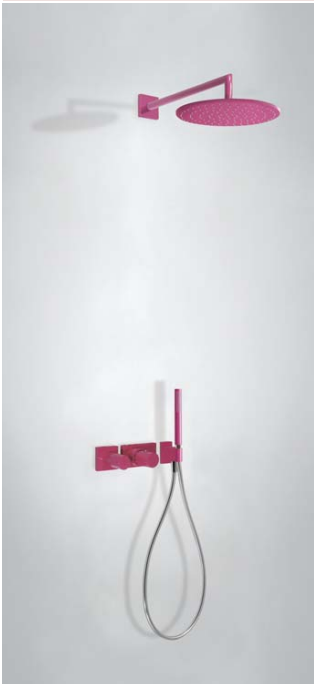

Kit doccia termostatica ad incasso BLOCK SYSTEM

- Con chiusura e regolazione di portata (2 vie).
- Corpo incassato termostatico incluso.
- Doccia fissa Ø 300 mm. con snodo. Ottone.
- Doccetta anticalcare.
- Flessibile satin (91.34.609.15).

Concealed thermostatic shower kit BLOCK SYSTEM
with water shut off and flow control (2 ways).

- Built-in thermostatic body included.
- Fixed shower head Ø 300 mm. with ball joint. Bras.
- Antilime hand shower.
- Shower hose SATIN (91.34.609.15).

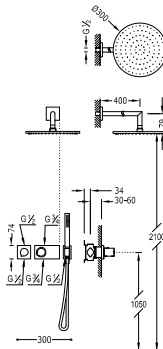
Podomítkový termostatický sprchový set BLOCK SYSTEM
s uzávěrem a regulací průtoku (2-cestná).

- Včetně podomítkového termostatického tělesa.
- Pevná sprcha Ø 300 mm. s kloubem. Materiál Mosaz.
- Ruční sprcha, proti usaz. vod. kamene.
- Flexi hadice SATIN (91.34.609.15).



299.195.03

Cr 207.352.01



Ac 207.352.01.AC

Bl-Mt 207.352.01.BM

207.352.01.TAM

207.352.01.TNA

207.352.01.TRO

207.352.01.TVI

207.352.01.TFU

207.352.01.TVE

207.352.01.TNE

207.352.01.TBL





Kit doccia termostatica ad incasso BLOCK SYSTEM

- Con chiusura e regolazione di portata (2 vie).
- Corpo incassato termostatico incluso.
- Doccia acciaio inossidabile da parete 210x550 mm. (299.903.07).
- Doccetta anticalcare (034.116.01).
- Flessibile satin (91.34.609.15).

Concealed thermostatic shower kit BLOCK SYSTEM

- with water shut off and flow control (2 ways).
- Built-in thermostatic body included.
- Stainless steel wall shower 210x550 mm. (299.903.07).
- Antilime hand shower (034.116.01).
- Shower hose SATIN (91.34.609.15).

Termostatický podomítkový sprchový set BLOCK SYSTEM

- s uzávěrem a regulací průtoku (2-cestná).
- Včetně podomítkového termostatického tělesa.
- Nástěnné sprchové křepitko z nerez. oceli 210x550 mm. (299.903.07).
- Ruční sprcha, proti usaz. vod. kamene (034.116.01).
- Flexi hadice SATIN (91.34.609.15).

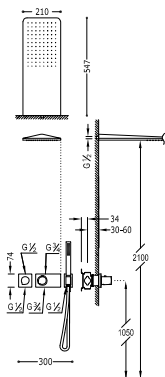

299.195.03

Cr | 207.352.02



TERMOSTATICA ELETTRONICA AD INCASSO / BUILT-IN ELECTRONIC THERMOSTATIC / PDOMÍTKOVÁ TERMOSTATICKÁ ELEKTRONICKÁ



Kit elettronico per doccia termostatica da incasso SHOWER TECHNOLOGY

- Centralina termostatica elettronica inclusa (2 vie).
- Doccia acciaio inossidabile da parete 210x550 mm. (299.903.07).
- Supporto per doccia (207.182.01).
- Doccetta anticalcare (034.116.01).
- Flessibile satin (91.34.609.15).

Built-in electronic thermostatic shower kit SHOWER TECHNOLOGY

- Electronic thermostatic control box included (2 ways).
- Stainless steel wall shower 210x550 mm. (299.903.07).
- Elbow wall (207.182.01).
- Antilime hand shower (034.116.01).
- Shower hose SATIN (91.34.609.15).

Termostatický podomítkový elektronický sprchový set SHOWER TECHNOLOGY

- Zabudovaná termostatická elektronická kontrolní jednotka (2-cestná).
- Nástěnné sprchové křepitko z nerez. oceli 210x550 mm. (299.903.07).
- Držák s nástěnným přívodem vody (207.182.01).
- Ruční sprcha, proti usaz. vod. kamene (034.116.01).
- Flexi hadice SATIN (91.34.609.15).

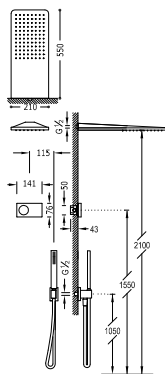

Cr | 092.865.54







LOFT COLORS



Lavabi
Basin mixer taps
Koupelnová baterie



Bidet
Bidets
Bidety



Monocomando esterno
Bathtub mixer taps
Jednopákový mechanismus vany



Monocomando ad incasso
Built-in sets
Vestavné soupravy



Bordovasca
Deck-mounted bathtubs
Vany s prodlouženým pultem



Termostatica esterna
Thermostatically-controlled
Termostatické



Termostatica ad incasso
Concealed thermostatic mixer
Podomítková termostatická baterie



Accessori
Accessories
Vybavení

www.tresgriferia.com



RICAMBI SU
SPARE PARTS AT
NÁHRADNÍ DÍLY NA
www.tresgriferia.com



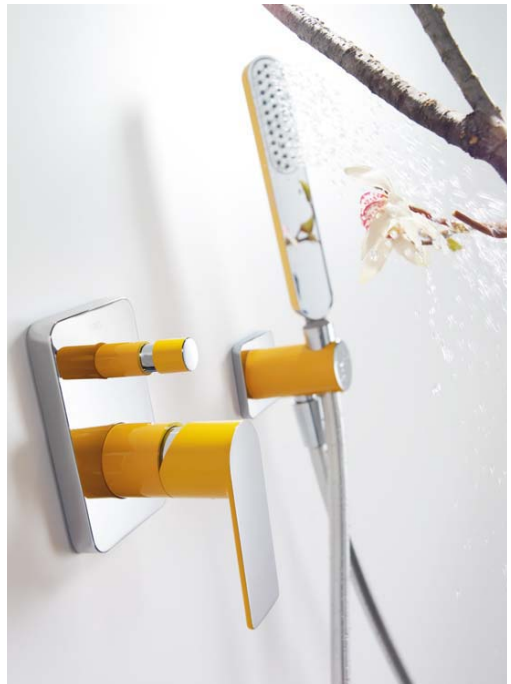

Monocomando lavabo
 Single lever washbasin mixer
 Jednópáková umyvadlová baterie

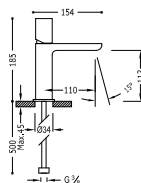

91.30.190

	200.103.02.AM.D
	200.103.02.NA.D
	200.103.02.RO.D
	200.103.02.VI.D
	200.103.02.FU.D
	200.103.02.VE.D
	200.103.02.NE.D
	200.103.02.BL.D

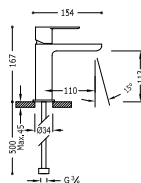

91.30.190

	200.103.01.AM.D
	200.103.01.NA.D
	200.103.01.RO.D
	200.103.01.VI.D
	200.103.01.FU.D
	200.103.01.VE.D
	200.103.01.NE.D
	200.103.01.BL.D

Monocomando lavabo
 Single lever washbasin mixer
 Jednópáková umyvadlová baterie

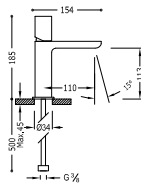

91.30.190

	Ac 200.103.02.ACD
	BI-Mt 200.103.02.BMD

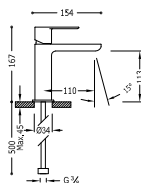

91.30.190

	Ac 200.103.01.ACD
	BI-Mt 200.103.01.BMD

Monocomando lavabo

con bocca a cascata aperta. NOTA: La rubinetteria con canna a cascata è accompagnata da 2 rubinetti di regolazione con filtro (Ref: 91.34.525)

Single lever washbasin mixer

with open cascade spout. NOTE: Taps with a cascade spout come with 2 regulation valves and a filter (Nr.: 91.34.525)

Jednopáková umyvadlová baterie

ramínko s otvoreným vodopádem. POZNÁMKA: Baterie typu vodopádu je doplněna dvěma regulačními kohouty s filtrem (Kód.: 91.34.525)

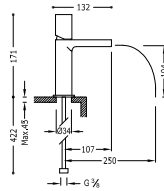

91.30.190

	200.110.02.AM.D
	200.110.02.NA.D
	200.110.02.RO.D
	200.110.02.VI.D
	200.110.02.FU.D
	200.110.02.VE.D
	200.110.02.NE.D
	200.110.02.BLD

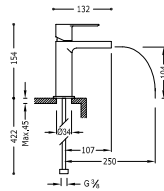

91.30.190

	200.110.01.AM.D
	200.110.01.NA.D
	200.110.01.RO.D
	200.110.01.VI.D
	200.110.01.FU.D
	200.110.01.VE.D
	200.110.01.NE.D
	200.110.01.BLD

Monocomando lavabo
 Single lever washbasin mixer
 Jednopaková umyvadlová baterie

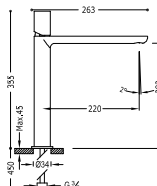
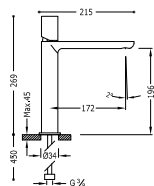
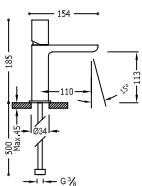

Icon	91.30.190	Icon
	200.103.02.AM.D	
	200.103.02.NA.D	
	200.103.02.RO.D	
	200.103.02.VI.D	
	200.103.02.FU.D	
	200.103.02.VE.D	
	200.103.02.NE.D	
	200.103.02.BL.D	

Icon	91.30.190	Icon
	200.203.04.AM.D	
	200.203.04.NA.D	
	200.203.04.RO.D	
	200.203.04.VI.D	
	200.203.04.FU.D	
	200.203.04.VE.D	
	200.203.04.NE.D	
	200.203.04.BL.D	

Icon	91.30.190	Icon
	200.203.06.AM.D	
	200.203.06.NA.D	
	200.203.06.RO.D	
	200.203.06.VI.D	
	200.203.06.FU.D	
	200.203.06.VE.D	
	200.203.06.NE.D	
	200.203.06.BL.D	

Monocomando lavabo
Single lever washbasin mixer
Jednopáková umyvadlová baterie

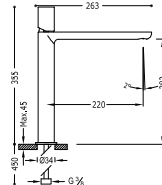
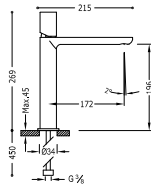
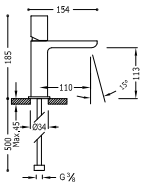

91.30.190

Ac **200.103.02.A.C.D** 
 BI-Mt 200.103.02.B.M.D 

91.30.190

Ac **200.203.04.A.C.D** 
 BI-Mt 200.203.04.B.M.D 

91.30.190

Ac **200.203.06.A.C.D** 
 BI-Mt 200.203.06.B.M.D 

Monocomando lavabo
 Single lever washbasin mixer
 Jednopláková umyvadlová baterie

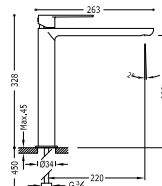
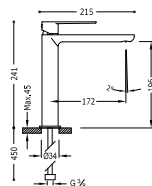
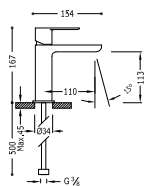

91.30.190	91.30.190	
	200.103.01.AM.D	
	200.103.01.NA.D	
	200.103.01.RO.D	
	200.103.01.VI.D	
	200.103.01.FU.D	
	200.103.01.VE.D	
	200.103.01.NE.D	
	200.103.01.BL.D	

91.30.190	91.30.190	
	200.203.03.AM.D	N
	200.203.03.NA.D	N
	200.203.03.RO.D	N
	200.203.03.VI.D	N
	200.203.03.FU.D	N
	200.203.03.VE.D	N
	200.203.03.NE.D	N
	200.203.03.BL.D	N

91.30.190	91.30.190	
	200.203.05.AM.D	N
	200.203.05.NA.D	N
	200.203.05.RO.D	N
	200.203.05.VI.D	N
	200.203.05.FU.D	N
	200.203.05.VE.D	N
	200.203.05.NE.D	N
	200.203.05.BL.D	N

Monocomando lavabo
Single lever washbasin mixer
Jednopáková umyvadlová baterie

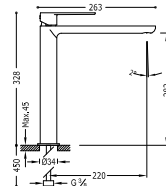
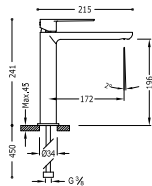
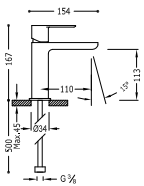

91.30.190

Ac **200.103.01.AC.D** 

BI-Mt **200.103.01.BM.D** 

91.30.190

Ac **200.203.03.AC.D** 

BI-Mt **200.203.03.BM.D** 

91.30.190

Ac **200.203.05.AC.D** 

BI-Mt **200.203.05.BM.D** 

Monocomando lavabo
Single lever washbasin mixer
Jednopáková umyvadlová baterie

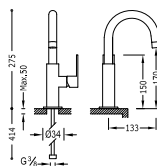

- 200.205.04.AM.D
- 200.205.04.NA.D
- 200.205.04.RO.D
- 200.205.04.VI.D
- 200.205.04.FU.D
- 200.205.04.VE.D
- 200.205.04.NE.D
- 200.205.04.BL.D

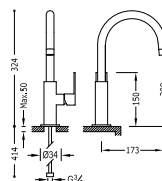

- 200.205.05.AM.D
- 200.205.05.NA.D
- 200.205.05.RO.D
- 200.205.05.VI.D
- 200.205.05.FU.D
- 200.205.05.VE.D
- 200.205.05.NE.D
- 200.205.05.BL.D

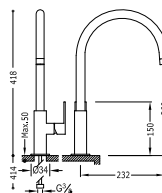

- 200.205.06.AM.D
- 200.205.06.NA.D
- 200.205.06.RO.D
- 200.205.06.VI.D
- 200.205.06.FU.D
- 200.205.06.VE.D
- 200.205.06.NE.D
- 200.205.06.BL.D

Monocomando lavabo
Single lever washbasin mixer
Jednopáková umyvadlová baterie

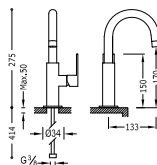

- Ac 200.205.04.ACD
- Bl-Mt 200.205.04.BM.D

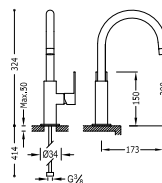

- Ac 200.205.05.ACD
- Bl-Mt 200.205.05.BM.D

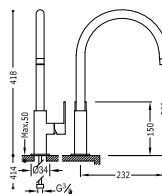

- Ac 200.205.06.ACD
- Bl-Mt 200.205.06.BM.D

Monocomando lavabo
canna 35x15 mm.

Single lever washbasin mixer
spout 35x15 mm.

Jednopáková umyvadlová baterie
ramínko 35x15 mm

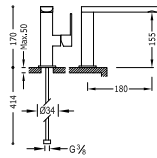

360° 91.30.190	200.205.01.AM.D
200.205.01.NA.D	200.205.01.RO.D
200.205.01.VI.D	200.205.01.FU.D
200.205.01.VE.D	200.205.01.NE.D
200.205.01.BL.D	

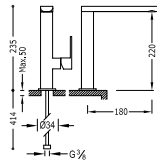

360° 91.30.190	200.205.02.AM.D
200.205.02.NA.D	200.205.02.RO.D
200.205.02.VI.D	200.205.02.FU.D
200.205.02.VE.D	200.205.02.NE.D
200.205.02.BL.D	

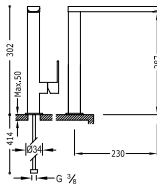

360° 91.30.190	200.205.03.AM.D
200.205.03.NA.D	200.205.03.RO.D
200.205.03.VI.D	200.205.03.FU.D
200.205.03.VE.D	200.205.03.NE.D
200.205.03.BL.D	

Monocomando lavabo
canna 35x15 mm.

Single lever washbasin mixer
spout 35x15 mm.

Jednopáková umyvadlová baterie
ramínko 35x15 mm

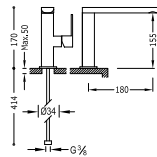

360° 91.30.190	Ac 200.205.01.AC.D
200.205.01.BL.D	

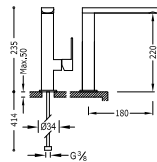

360° 91.30.190	Ac 200.205.02.AC.D
200.205.02.BL.D	

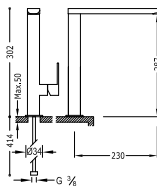

360° 91.30.190	Ac 200.205.03.AC.D
200.205.03.BL.D	

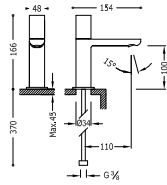

Rubinetto lavandino 1 acqua o premiscelata
1 water or premixed bathroom tap
 Umyvadlová baterie pro jednu nebo předem smíchanou vodu



91.30.190
Ac 200.503.01.AC

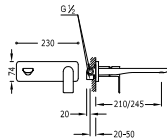

Monomando a muro
Single lever wall washbasin mixer
 Jednopávková nástěnná baterie



91.30.190 (245 mm)
Ac 200.200.02.AC



BIDET / BIDETS / BIDETY

Monocomando bidet
Single lever bidet mixer
 Jednopávková bidetová baterie

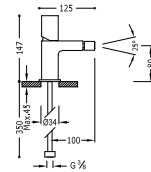

- 91.30.190
- 200.120.02.AM.D
 - 200.120.02.NA.D
 - 200.120.02.RO.D
 - 200.120.02.VI.D
 - 200.120.02.FU.D
 - 200.120.02.VE.D
 - 200.120.02.NE.D
 - 200.120.02.BL.D



Monocomando bidet
Single lever bidet mixer
 Jednopávková bidetová baterie

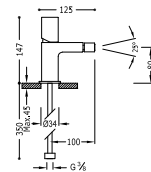

91.30.190
Ac 200.120.02.AC.D
Bl-Mt 200.120.02.BL.M.D



Monocomando bidet
Single lever bidet mixer
 Jednopávková bidetová baterie



91.30.190
Ac 200.120.01.AC.D
Bl-Mt 200.120.01.BL.M.D



Monocomando bidet
Single lever bidet mixer
Jednopáková bidetová baterie

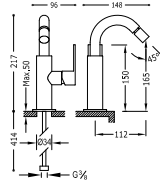

360° 91.30.190

- 200.224.01.AM.D
- 200.224.01.NA.D
- 200.224.01.RO.D
- 200.224.01.VLD
- 200.224.01.FU.D
- 200.224.01.VE.D
- 200.224.01.NE.D
- 200.224.01.BLD

Monocomando bidet
Single lever bidet mixer
Jednopáková bidetová baterie

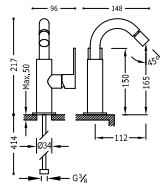

360° 91.30.190

- Ac 200.224.01.AC.D
- Bl-Mt 200.224.01.BM.D

MONOCOMANDI BAGNO / BATHTUB MIXER TAPS / JEDNOPÁKOVÝ MECHANIZMUS VANY

Monocomando doccia
Doccetta anticalcare con supporto orientabile. Flessibile satin
(91.34.609.15).

Single lever shower mixer
Anti-limescale hand shower with directable support. Shower hose satin
(91.34.609.15).

Sprchová baterie
Ruční sprcha s nastavitelným držákem, proti usaz. vod. kamene.
Flexi hadice SATIN (91.34.609.15).

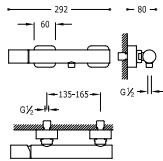

91.30.190

- 200.167.01.AM
- 200.167.01.NA
- 200.167.01.RO
- 200.167.01.VI
- 200.167.01.FU
- 200.167.01.VE
- 200.167.01.NE
- 200.167.01.BL

Monocomando doccia
Doccetta anticalcare con supporto orientabile. Flessibile satin
(91.34.609.15).

Single lever shower mixer
Anti-limescale hand shower with directable support. Shower hose satin
(91.34.609.15).

Sprchová baterie
Ruční sprcha s nastavitelným držákem, proti usaz. vod. kamene.
Flexi hadice SATIN (91.34.609.15).

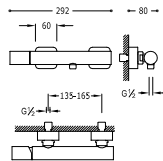

91.30.190

- Ac 200.167.01.AC
- Bl-Mt 200.167.01.BM

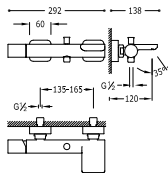

Monocomando vasca

Con bocca a cascata. Doccetta anticalcare con supporto orientabile. Flessibile satin (91.34.609).

Single lever bath and shower mixer with cascade. Anti-limescale hand shower with directable support. Shower hose satin (91.34.609).

Vanová baterie s kaskádou. Ruční sprcha s nastavitelným držákem, proti usaz. vod. kamene. Flexi hadice SATIN (91.34.609).

91.30.190	
200.170.01.AM	
200.170.01.NA	
200.170.01.RO	
200.170.01.VI	
200.170.01.FU	
200.170.01.VE	
200.170.01.NE	
200.170.01.BL	

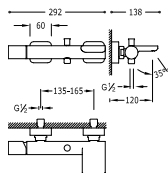

Monocomando vasca

Con bocca a cascata. Doccetta anticalcare con supporto orientabile. Flessibile satin (91.34.609).

Single lever bath and shower mixer with cascade. Anti-limescale hand shower with directable support. Shower hose satin (91.34.609).

Vanová baterie s kaskádou. Ruční sprcha s nastavitelným držákem, proti usaz. vod. kamene. Flexi hadice SATIN (91.34.609).

91.30.190	
Ac	200.170.01.AC
Bl-Mt	200.170.01.BM

GRUPPI AD INCASSO / BUILT-IN SETS / VESTAVĚNÉ SOUPRAVY

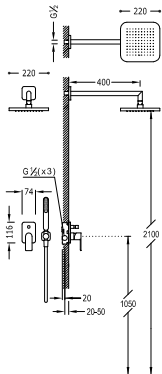

Kit doccia ad incasso

Con chiusura e regolazione di portata.
 · Corpo incassato incluso
 · Doccia fissa 220x220 mm. con snodo. (299.632.06).
 · Supporto per doccia.
 · Doccetta anticalcare.
 · Flessibile satin (91.34.609.15).

Concealed shower set

with water shut off and flow control.
 · Built-in body included
 · Fixed shower head 220x220 mm. with ball joint. (299.632.06).
 · Elbow wall.
 · Antilime hand shower.
 · Satin hose (91.34.609.15).

Podomítkový jednopákový sprchový set

s uzávěrem a regulací průtoku.
 · Včetně podomítkového tělesa
 · Pevná sprcha 220x220 mm. s kloubem. (299.632.06).
 · Držák s nástěnným přívodem vody.
 · Ruční sprcha, proti usaz. vod. kamene.
 · Flexi hadice SATIN (91.34.609.15).

91.30.190	
200.180.02.AM	
200.180.02.NA	
200.180.02.RO	
200.180.02.VI	
200.180.02.FU	
200.180.02.VE	
200.180.02.NE	
200.180.02.BL	



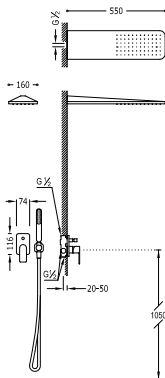

Kit doccia ad incasso

Con chiusura e regolazione di portata.

- Corpo incassato incluso
- Doccia acciaio inossidabile da parete 160x550 mm.
- Supporto per doccia.
- Doccetta anticalcare.
- Flessibile satin (91.34.609.15).

Concealed shower set

with water shut off and flow control.

- Built-in body included
- Stainless steel wall shower 160x550 mm.
- Elbow wall.
- Antilime hand shower.
- Satin hose (91.34.609.15).

Podomítkový jednopákový sprchový set

s uzávěrem a regulací průtoku.

- Včetně podomítkového tělesa
- Nástěnné sprchové křepitko z nerez. oceli 160x550 mm.
- Držák s nástěnným přívodem vody.
- Ruční sprcha, proti usaz. vod. kamene.
- Flexi hadice SATIN (91.34.609.15).



91.30.190

Ac | 200.180.05.AC

Bl-Mt | 200.180.05.BM



BORDOVAŠKA / DECK-MOUNTED BATHTUBS / VÁNY S PRODLOUŽENÝM PULTEM

Monocomando bordo vasca

con doccetta anticalcare.

- Portata: 3 bar – 16 l/m.
- NOTA: vedere lunghezza canna.

Bath-shower single lever tap for bracket shelf

with shower antilime.

- Flowrate: 3 bar – 16 l/m.
- NOTE: see pipe length

Jednopáková stojánková vanová baterie

Sprcha, proti usaz. vod. kamene.

- Průtok: 3 bar – 16 l/m
- POZNÁMKA: viz délka ramínka

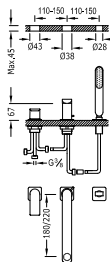

91.34.591 (180 mm.)

Ac | 200.162.03.AC



91.34.591 (220 mm.)

Ac | 200.162.01.AC

TERMOSTATICHE / THERMOSTATICALLY-CONTROLLED / TERMOSTATICKÉ

Doccia termostatica

Doccetta anticalcare con supporto orientabile. Flessibile satin (91.34.609.15).

Wall thermostatic shower mixer

Anti-limescale hand shower with directable support and satin hose (91.34.609.15).

Termostatická sprchová baterie

Ruční sprcha s nastavitelným držákem, proti usaz. vod. kamene a flexi hadice SATIN (91.34.609.15).

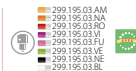
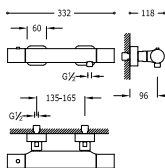

200.164.09.AM

200.164.09.NA

200.164.09.RO

200.164.09.VI

200.164.09.FU

200.164.09.VE

200.164.09.NE

200.164.09.BL



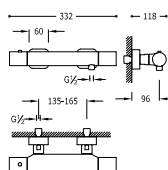

Doccia termostatica
Doccetta anticalcare con supporto orientabile. Flessibile satin
(91.34.609.15).

Wall thermostatic shower mixer
Anti-limescale hand shower with directable support and satin
hose (91.34.609.15).

Termostatická sprchová baterie
Ruční sprcha s nastavitelným držákem, proti usaz. vod. kamene a
flexi hadice SATIN (91.34.609.15).



Ac **200.164.09.AC**
BI-Mt **200.164.09.BM**

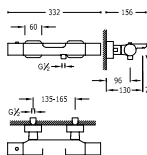

Vasca-Doccia termostatica
Con bocca a cascata. Doccetta anticalcare con supporto orientabile.
Flessibile satin (91.34.609).

Wall thermostatic shower mixer
With cascade. Anti-limescale hand shower with directable support
and satin hose (91.34.609).

Termostatická baterie pro vanu-sprchu
s kaskádou. Ruční sprcha s nastavitelným držákem, proti usaz. vod.
kamene a flexi hadice SATIN (91.34.609).



Ac 299.195.03.AC
BI-Mt 299.195.03.BM

- 299.195.03.AM
- 299.195.03.NA
- 299.195.03.RO
- 299.195.03.FU
- 299.195.03.VI
- 299.195.03.VE
- 299.195.03.NE
- 299.195.03.BL

200.174.09.AM
200.174.09.NA
200.174.09.RO
200.174.09.VI
200.174.09.FU
200.174.09.VE
200.174.09.NE
200.174.09.BL

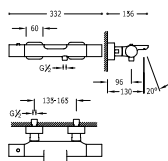

Vasca-Doccia termostatica
Con bocca a cascata. Doccetta anticalcare con supporto orientabile.
Flessibile satin (91.34.609).

Wall thermostatic shower mixer
With cascade. Anti-limescale hand shower with directable support
and satin hose (91.34.609).

Termostatická baterie pro vanu-sprchu
s kaskádou. Ruční sprcha s nastavitelným držákem, proti usaz. vod.
kamene a flexi hadice SATIN (91.34.609).



Ac **200.174.09.AC**
BI-Mt **200.174.09.BM**



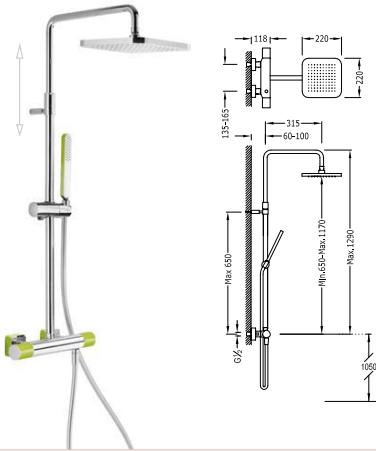

Set doccia termostatica

- Doccia fissa 220x220 mm. con snodo. (299.632.06).
- Doccetta anticalcare.
- Flessibile satin (91.34.609.15).
- Asta telescopica.
- Invertitore integrato nel regolatore di portata.

Wall thermostatic shower mixer

- Fixed shower head 220x220 mm. with ball joint. (299.632.06).
- Antilime hand shower.
- Satin hose (91.34.609.15).
- Telescopic bar.
- Diverter integrated in the flow control.

Souprava termostatické sprchové baterie

- Pevná sprcha 220x220 mm. s kloubem. (299.632.06).
- Ruční sprcha, proti usaz. vod. kamene.
- Flexi hadice SATIN (91.34.609.15).
- Teleskopická tyč.
- Přepínač zabudovaný v regulaci průtoku

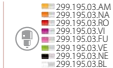

	200.195.01.AM
	200.195.01.NA
	200.195.01.RO
	200.195.01.VI
	200.195.01.FU
	200.195.01.VE
	200.195.01.NE
	200.195.01.BL





easy CLEAN

FACILE MANUTENZIONE Con la tecnologia EasyCLEAN®, TRES offre la possibilità di pulire la cartuccia termostatica in caso di malfunzionamento od ostruzione facilitandone il montaggio e smontaggio.

EASY MAINTENANCE With EasyCLEAN® technology, TRES makes it possible to clean the cartridge if it is blocked or not working properly, facilitating the assembly and disassembly of the thermostatic cartridge.

SNADNÁ ÚDRŽBA Technologie EasyCLEAN® společnosti TRES usnadňuje montáž a demontáž termostatického ventilu a nabízí tak možnost vyčištění ventilu v případě nesprávného fungování nebo ucpaní a.

TERMOSTATICA AD INCASSO / CONCEALED THERMOSTATIC MIXER / PODOMÍTKOVÁ TERMOSTATICKÁ BATERIE

Ref. / Nr. / Kód:



- Kit doccia termostatica ad incasso BLOCK SYSTEM
 Con chiusura e regolazione di portata (2 vie).
 - Corpo incassato termostatico incluso
 - Doccia acciaio inossidabile da parete 210x550 mm. (299.903.07).
 - Doccetta anticalcare.
 - Flessibile satin (91.34.609.15).

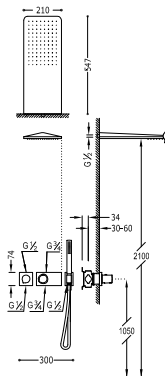

- Concealed thermostatic shower kit BLOCK SYSTEM
 with water shut off and flow control (2 ways).
 - Built-in thermostatic body included
 - Stainless steel wall shower 210x550 mm. (299.903.07).
 - Antilime hand shower.
 - Satin hose (91.34.609.15).

- Podomítkový termostatický sprchový set BLOCK SYSTEM
 s uzávěrem a regulací průtoku (2-cestná).
 - Včetně podomítkového termostatického tělesa
 - Nástěnné sprchové křepitko z nerez. oceli 210x550 mm. (299.903.07)
 - Ruční sprcha, proti usaz. vod. kamene.
 - Flexi hadice SATIN (91.34.609.15).

	207.352.02.AM
	207.352.02.NA
	207.352.02.RO
	207.352.02.VI
	207.352.02.FU
	207.352.02.VE
	207.352.02.NE
	207.352.02.BL



- Kit doccia termostatica ad incasso BLOCK SYSTEM
 Con chiusura e regolazione di portata (2 vie).
 - Corpo incassato termostatico incluso
 - Doccia acciaio inossidabile da parete 210x550 mm.
 - Doccetta anticalcare.
 - Flessibile satin (91.34.609.15).

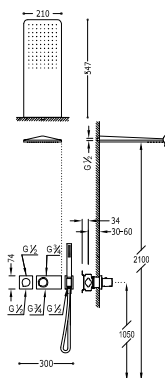

- Concealed thermostatic shower kit BLOCK SYSTEM
 with water shut off and flow control (2 ways).
 - Built-in thermostatic body included
 - Stainless steel wall shower 210x550 mm.
 - Antilime hand shower.
 - Satin hose (91.34.609.15).

- Podomítkový termostatický sprchový set BLOCK SYSTEM
 s uzávěrem a regulací průtoku (2-cestná).
 - Včetně podomítkového termostatického tělesa
 - Nástěnné sprchové křepitko z nerez. oceli 210x550 mm.
 - Ruční sprcha, proti usaz. vod. kamene.
 - Flexi hadice SATIN (91.34.609.15).

	Ac 299.195.03.AC
	Bl-Mt 299.195.03.BM
	Ac 207.352.02.AC
	Bl-Mt 207.352.02.BM









CUCINA EXCLUSIVE KITCHEN EXCLUSIVE KUCHYNĚ EXCLUSIVE



Monocomando
Mixer taps
S jednopákovým mechanismem



Con manico estraibile
With detachable spray nozzle
S výsuvnou sprškou



Reclinabile
Folding kitchen taps
Dřezová sklopná baterie



Cucina a parete
Wall kitchen
Nástěnné kuchyňské baterie

www.tresgriferia.com



RICAMBI SU
SPARE PARTS AT
NÁHRADNÍ DÍLY NA
www.tresgriferia.com





CUCINE CHE SPICCANO OUTSTANDING KITCHENS KUCHYNĚ, KTERÉ VYNIKAJÍ

Caratteristiche generali / General characteristics / Všeobecné vlastnosti

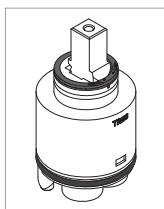

Cartuccia ceramica brevettata®. La cartuccia TRES evita l'usura dei dischi quando il rubinetto è chiuso, prolungandone la durata. / Patented® Ceramic Cartridge. The TRES cartridge prevents wear and tear of the disks with the tap closed, thus lengthening its useful life. / Keramická kartuš Patentado®. Kartuš TRES zabraňuje opotřebení disků v době, kdy je baterie zavřená, čímž prodlužuje její životnost.

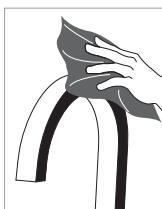

Finiture speciali. Elementi resistenti rifiniti e lucidati a mano con vernici ecologiche senza solventi. / Special finishes. Strong parts, hand finished and polished with environmentally-friendly solvent-free paints. / Zvláštní povrchové úpravy. Odolné díly s ručně upraveným povrchem, leštěné a s použitím ekologických barev bez rozpouštědel.

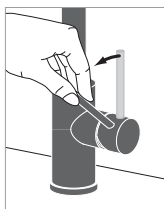

Manopola con rotazione frontale. Evita che la manopola sbatta contro la parete. / Front rotating handle. Prevents the handle from hitting the wall. / Páka s čelní rotací. Zabraňuje narážení páky do stěny.

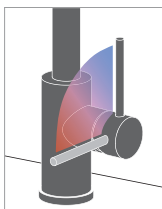

Risparmio energetico con Cold-Tres®. Il rubinetto si apre sempre con l'acqua fredda, evitando inutili accensioni dello scaldabagno / Cold-Tres® energy savings. The tap always turns on with cold water, preventing unnecessary activation of the water heater. / Úspora energie Cold-Tres®. Baterie se vždy spouští se studenou vodou a zamezuje tak zbytečnému spouštění ohřívače.

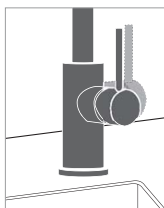

Installazione variabile. La posizione del monocomando può essere a destra o a sinistra a seconda delle esigenze personali. / Variable installation. The mixer tap can be installed on the right or the left, according to personal needs. / Různé možnosti instalace. Páku je možno instalovat vpravo či ve středu, zcela dle osobních potřeb uživatele.*



Design moderni e minimalisti. Combinano la cromatura con vari colori, oltre a finiture in acciaio e in bianco opaco. / Modern, minimalist designs. Chrome plating in different colours, as well as steel and matte white finishes. / Moderní a minimalistický design. Kombinují různé barvy spolu s chromováním, nerezovou ocelí či matnou bílou barvou.

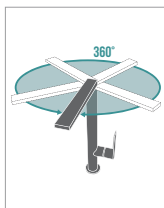

Canna girevole. Con completa libertà di movimento a 360°. / Rotating spout. With total 360° freedom of movement. / Otočná trubice. S naprostou volností pohybu o 360°.

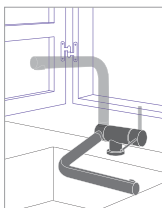

Reclinabile. Ideale per l'installazione di fronte a finestre o armadi. All'occorrenza questa rubinetteria si può girare e reclinare. / Folding. Ideal when installed in front of windows or cupboards. This tapware can be turned and lowered as required. / Sklápěcí. Ideální pro instalaci u oken či skříněk. Tato baterie nabízí v případě nutnosti možnost otočení a sklopení.

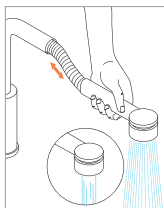

Canna o doccia retrattile. Aumenta il raggio d'azione e può offrire diversi tipi di getti. / Retractable spout or shower. Increases the radius of action and has different jet types. / Zatahovací sprcha či trubice. Zvyšuje akční rádius sprchy, přičemž nabízí různé typy výstupů vody.

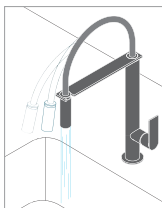

Canna estraibile. Permette di estendere la zona di lavoro da 50 a 70 cm. / Detachable spout. Enabling the operating area to be widened from 50 to 70 cm. / Výsuvná trubice. Umožňuje zvětšení pracovní plochy o 50 až 70 cm.



Acciaio / Steel / Ocel

Finitura in acciaio spazzolato, dà un tocco professionale e industriale molto moderno.
Brushed steel finish, adding a very modern professional and industrial touch.
Povrch z kartáčované oceli dodává moderní, industriální a profesionální vzhled.

Bianco-Opaco / Matte-White / Bílá matná barva

Completamente di color bianco e non brillante, che dà originalità e raffinatezza all'elemento.
Totally white, non-gloss finish, adding a note of singularity and refinement to the fitting.
Čistá bílá barva bez lesku dodává baterii jedinečný a elegantní vzhled.

CUCINA MONOCOMANDO / KITCHEN MIXER TAPS / DŘEZOVÉ BATERIE S JEDNOPÁKOVÝM MECHANISMEM

Ref. / Nr. / Kód:

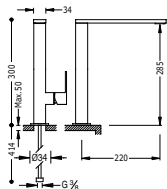

Monocomando lavello verticale CUADRO
canna 34x10 mm.

Single lever single hole sink mixer CUADRO
spout 34x10 mm

Jednopáková dřezová kuchyňská baterie CUADRO
ramínko 34x10 mm



	Ø 35 360° 91.30.190
	1.06.486.AM
	1.06.486.NA
	1.06.486.RO
	1.06.486.VI
	1.06.486.FU
	1.06.486.VE
	6.06.486
	4.06.486

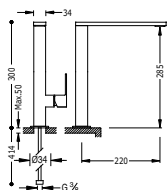

Monocomando lavello verticale CUADRO
canna 34x10 mm.

Single lever single hole sink mixer CUADRO
spout 34x10 mm

Jednopáková dřezová kuchyňská baterie CUADRO
ramínko 34x10 mm



	Ø 35 360° 91.30.190
Ac	5.06.486.03
Bl-Mt	006.486.BM

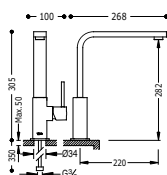

Monocomando lavello verticale CUADRO
canna tubo 35x15 mm.

Single lever single hole sink mixer CUADRO
spout 35x15 mm.

Jednopáková dřezová kuchyňská baterie CUADRO
ramínko 35x15 mm

	Ø 35 360° 91.30.190
Ac	5.30.496.03
Bl-Mt	030.496.BM

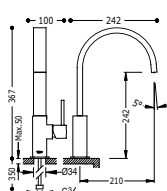

Monocomando lavello verticale CUADRO
canna tubo 35x15 mm. aeratore rettangolare

Single lever single hole sink mixer CUADRO
spout 35x15 mm. Rectangular Aerator

Jednopáková dřezová kuchyňská baterie CUADRO
ramínko 35x15 mm se skrytým obdélníkovým perlátorem

	Ø 35 360° 91.30.190
Ac	5.30.498.03
Bl-Mt	030.498.BM

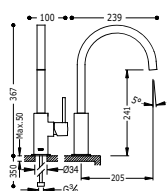

Monocomando lavello verticale CUADRO
canna tubo 22x22 mm.

Single lever single hole sink mixer CUADRO
spout 22x22 mm.

Jednopáková dřezová kuchyňská baterie CUADRO
ramínko 22x22 mm

	Ø 35 360° 91.30.190
Ac	5.30.497.03
Bl-Mt	030.497.BM

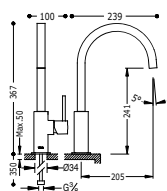

Monocomando lavello verticale CUADRO
canna 22x22 mm.

Single lever single hole sink mixer CUADRO
spout 22x22 mm.

Jednopáková dřezová kuchyňská baterie CUADRO
ramínko 22x22 mm

	Ø 35 360° 91.30.190
	1.30.497.AM
	1.30.497.NA
	1.30.497.RO
	1.30.497.VI
	1.30.497.FU
	1.30.497.VE
	6.30.497
	4.30.497



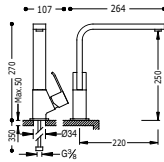

Monocomando lavello verticale CUADRO
canna tubo 35x15 mm.

Single lever single hole sink mixer CUADRO
spout 35x15 mm.

Jednopáková dřezová kuchyňská baterie CUADRO
ramínko 35x15 mm



Ac | 5.06.440.03

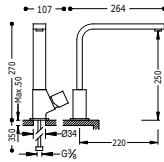

Monocomando lavello verticale CUADRO
canna tubo 35x15 mm.

Single lever single hole sink mixer CUADRO
spout 35x15 mm.

Jednopáková dřezová kuchyňská baterie CUADRO
ramínko 35x15 mm



Ac | 5.07.440.03

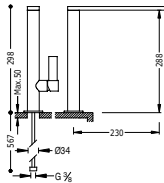

Monocomando lavello verticale CLASS
canna 34x9 mm.

Single lever single hole sink mixer CLASS
spout 34x9 mm.

Jednopáková dřezová kuchyňská baterie CLASS
ramínko 34x9 mm



Ac | 205.486.01.AC

Bl-Mt | 205.486.01.BM

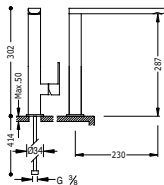

Monocomando lavello verticale LOFT
canna 34x15 mm.

Single lever single hole sink mixer LOFT
spout 34x15 mm.

Jednopáková dřezová kuchyňská baterie LOFT
ramínko 34x15 mm



200.440.01.AM

200.440.01.NA

200.440.01.RO

200.440.01.VI

200.440.01.FU

200.440.01.VE

200.440.01.NE

200.440.01.BL

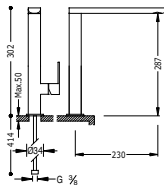

Monocomando lavello verticale LOFT
canna 34x15 mm.

Single lever single hole sink mixer LOFT
spout 34x15 mm.

Jednopáková dřezová kuchyňská baterie LOFT
ramínko 34x15 mm



Ac | 200.440.01.AC

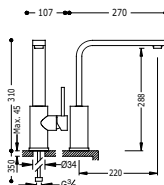

Monocomando lavello verticale
canna 35x15 mm.

Single lever single hole sink mixer
spout 35x15 mm.

Jednopáková dřezová kuchyňská baterie
ramínko 35x15 mm



Ac | 062.435.AC

Bl-Mt | 062.435.BM



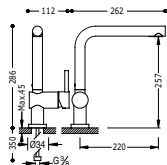

Monocomando lavello verticale
Single lever single hole sink mixer
Jedn3p3kov3 dřeřov3 kuchyŇisk3 baterie



Ac **030.336.AC**
BI-Mt **030.336.BM**

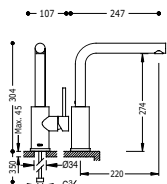

Monocomando lavello verticale MAX
Single lever single hole sink mixer MAX
Jedn3p3kov3 dřeřov3 kuchyŇisk3 baterie MAX



Ac **062.436.01.AC**
BI-Mt **062.436.01.BM**

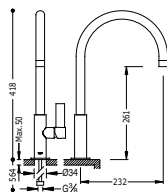

Monocomando lavello verticale CLASS
Single lever single hole sink mixer CLASS
Jedn3p3kov3 dřeřov3 kuchyŇisk3 baterie CLASS



Ac **205.440.01.AC**
BI-Mt **205.440.01.BM**

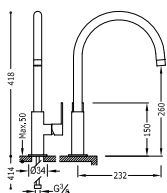

Monocomando lavello verticale LOFT
Single lever single hole sink mixer LOFT
Jedn3p3kov3 dřeřov3 kuchyŇisk3 baterie LOFT



Ac **200.440.02.AM**
200.440.02.NA
200.440.02.RO
200.440.02.VI
200.440.02.FU
200.440.02.VE
200.440.02.NE
200.440.02.BL

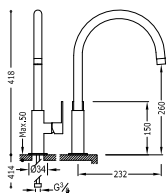

Monocomando lavello verticale LOFT
Single lever single hole sink mixer LOFT
Jedn3p3kov3 dřeřov3 kuchyŇisk3 baterie LOFT



Ac **200.440.02.AC**
BI-Mt **200.440.02.BM**

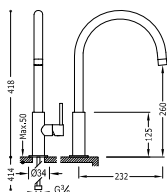

Monocomando lavello verticale MAX
Single lever single hole sink mixer MAX
Jedn3p3kov3 dřeřov3 kuchyŇisk3 baterie MAX



Ac **062.542.01.AC**
BI-Mt **062.542.01.BM**



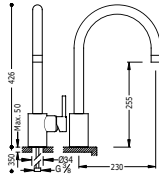

Monocomando lavello verticale MAX
Single lever single hole sink mixer MAX
Jednopaková dřezová kuchyňská baterie MAX



Ac 5.62.440.03

DESIGN FUNZIONALI Per quei posti dove occorre una maggiore comodità e libertà di azione.

FUNCTIONAL DESIGNS For those areas where more comfort and freedom of action is required.

FUNKČNÍ TVARY Určená do míst, kde je zapotřebí větší pohodlí a volnost pohybu.



CUCINA CON MANICO ESTRAIBILE / KITCHEN TAPS WITH DETACHABLE SPRAY NOZZLE / DŘEZOVÁ BATERIE S VÝSUVNOU SPRŠKOU

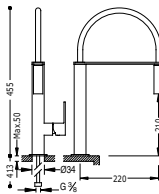

Monocomando lavello verticale CUADRO
estraibile
Single lever single hole sink mixer CUADRO
with removable spout
Jednopaková dřezová kuchyňská baterie CUADRO
s vyjímatelným kropicítkem



0 35	360°	91.30.190	1.06.487.AM
0 35	360°	91.34.290	1.06.487.NA
0 35	360°	91.34.290	1.06.487.RO
0 35	360°	91.34.290	1.06.487.VI
0 35	360°	91.34.290	1.06.487.FU
0 35	360°	91.34.290	1.06.487.VE
0 35	360°	91.34.290	6.06.487
0 35	360°	91.34.290	4.06.487

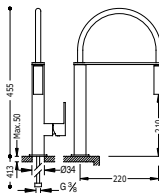

Monocomando lavello verticale CUADRO
estraibile
Single lever single hole sink mixer CUADRO
with removable spout
Jednopaková dřezová kuchyňská baterie CUADRO
s vyjímatelným kropicítkem



0 35	360°	91.30.190	Ac 5.06.487.03
0 35	360°	91.30.190	Bi-Mt 006.487.BM

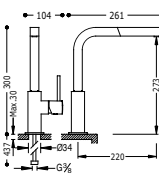

Monocomando lavello verticale CUADRO
estraibile
Single lever single hole sink mixer CUADRO
with removable spout
Jednopaková dřezová kuchyňská baterie CUADRO
s vyjímatelným kropicítkem



0 35	360°	91.07.190.05	Ac 5.06.437.03
0 35	360°	91.07.190.05	Bi-Mt 006.437.BM

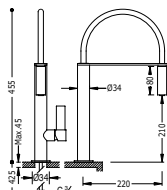

Monocomando lavello verticale CLASS
estraibile

Single lever single hole sink mixer CLASS
with removable spout

Jednopávková dřezová kuchyňská baterie CLASS
s vyjímatelným kropicítkem



Ac 205.487.01.AC
Bl-Mt 205.487.01.BM

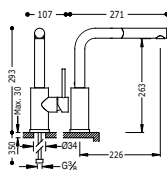

Monocomando lavello verticale MAX
estraibile

Single lever single hole sink mixer MAX
with removable spout

Jednopávková dřezová kuchyňská baterie MAX
s vyjímatelným kropicítkem



Ac 5.62.437.03

CUCINA RECLINABILE / FOLDING KITCHEN TAPS / DŘEZOVÁ BATERIE SKLOPNÁ

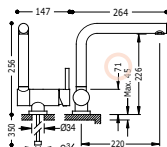

Monocomando lavello verticale ABBATTIBILE
Single lever single hole sink mixer FOLDING

Jednopávková dřezová kuchyňská baterie SKLOPNÁ



Ac 030.335.AC



Bl-Mt 030.335.BM

CUCINA A PARETE / WALL KITCHEN / NÁSTĚNNÉ KUCHYŇSKÉ BATERIE

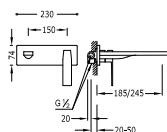

Monomando a muro SLIM

Single lever wall washbasin mixer SLIM

Jednopávková nástěnná baterie SLIM

91.30.190 (185 mm.)
Cr 202.200.03

91.30.190 (245 mm.)
Cr 202.200.04
Ac 202.200.04.AC

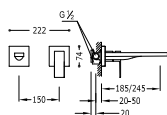

Monomando a muro CUADRO

Single lever wall washbasin mixer CUADRO

Jednopávková nástěnná baterie CUADRO

91.30.190 (185 mm.)
Ac 006.200.12.AC

91.30.190 (245 mm.)
Ac 006.200.11.AC

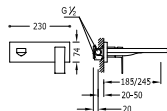

Monomando a muro CUADRO

Single lever wall washbasin mixer CUADRO

Jednopávková nástěnná baterie CUADRO

91.30.190 (185 mm.)
Ac 006.200.03.AC

91.30.190 (245 mm.)
Ac 006.200.04.AC



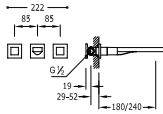

Monoblocco a muro CUADRO
Single hole wall mixer CUADRO
Nástěnná umyvadlová baterie CUADRO

(180 mm.)
91.34.282

Ac | 008.153.01.AC |

(240 mm.)
91.34.282

Ac | 008.154.01.AC |

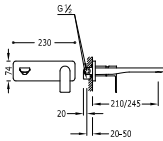

Monomando a muro LOFT
Single lever wall mixer LOFT
Jednopáková nástěnná baterie LOFT

(245 mm.)
91.30.190

Ac | 200.200.02.AC |

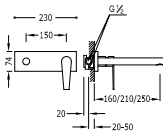

Monomando a muro CLASS
Single lever wall washbasin mixer CLASS
Jednopáková nástěnná baterie CLASS

(210 mm.)
91.30.190

Ac | 205.200.41.AC |

(250 mm.)
91.30.190

Ac | 205.200.01.AC |

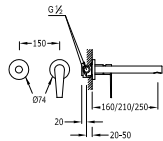

Monomando a muro CLASS
Single lever wall washbasin mixer CLASS
Jednopáková nástěnná baterie CLASS

(210 mm.)
91.30.190

Ac | 205.200.71.AC |

(250 mm.)
91.30.190

Ac | 205.200.02.AC |

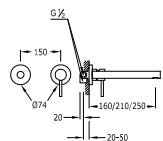

Monomando a muro MAX
Single lever wall washbasin mixer MAX
Jednopáková nástěnná baterie MAX

(210 mm.)
91.30.190

Ac | 062.200.71.AC |

(250 mm.)
91.30.190

Ac | 062.200.03.AC |

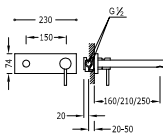

Monomando a muro MAX
Single lever wall mixer MAX
Jednopáková nástěnná baterie MAX

(210 mm.)
91.34.592

Ac | 062.200.02.AC |

(250 mm.)
91.34.592

Ac | 062.200.AC |

Bl-Mt | 062.200.BM |



SPAZIO DOCCIA SPAZIO VASCA SHOWER SPACE BATH SPACE SPRCHOVÝ PROSTOR VANOVÝ PROSTOR



Block system®



Block system®



Shower technology®

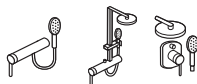

Mono-Term®



Monocomandi a 3 vie
3-way mixer taps
Jednopakové baterie se 3 přívody



Monocomandi a 2 vie
2-way mixer taps
Jednopakové baterie se 2 přívody



Programma per docce
Bath space
Vanový prostor

www.tresgriferia.com



RICAMBI SU
SPARE PARTS AT
NÁHRADNÍ DÍLY NA
www.tresgriferia.com





BLOCK
SYSTEM



PRIMA DI INIZIARE... BEFORE YOU START... NEŽ ZAČNETE...

Quante vie di uscita dell'acqua desiderate?
How many water outlets do you want?
Kolikacestný výstup vody si přejete?

1 vie / way / cestná

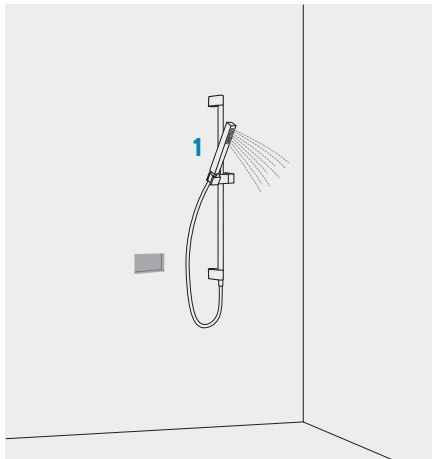

2 vie / ways / cestná

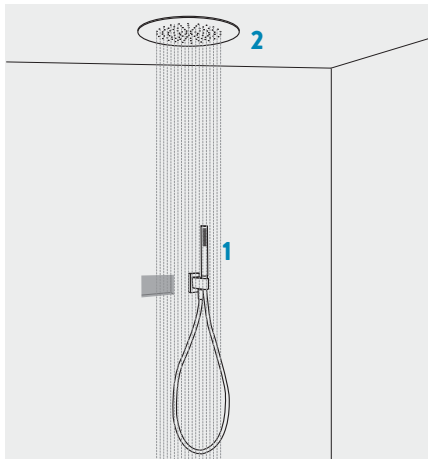

3 vie / ways / cestná

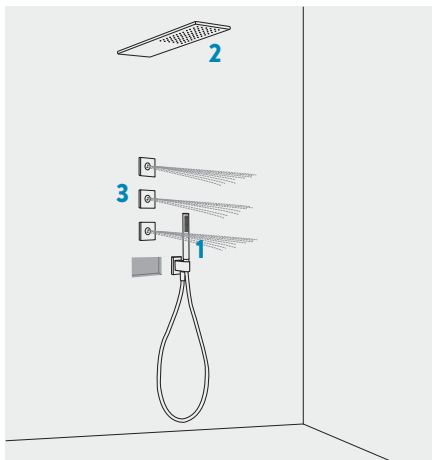

4 vie / ways / cestná

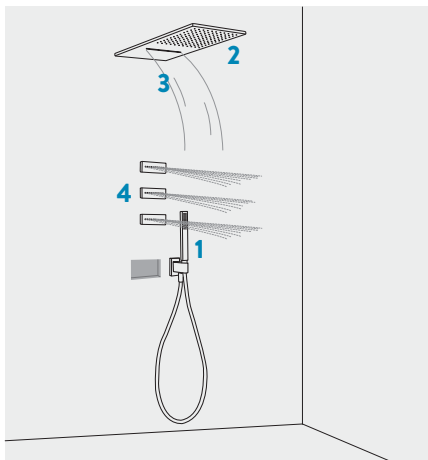

*Le illustrazioni sono esemplificative. Esistono molteplici combinazioni di vie d'uscita dell'acqua. / See the illustrations for examples.
There are many combinations of water outlets. / Vyobrazení jsou pouze příklady. Existuje mnoho kombinací výstupů vody.*

Scelta del sistema di controllo
Selection of a control system
Volba ovládacího systému
DA 1 A 4 VIE / 1 TO 4 OUTLETS / 1 AŽ 4CESTNÝ

Block system®

Gruppo termostatico incassato di grande semplicità e bellezza, con manopola della temperatura precisa e manopole per il controllo del flusso. / **Very simple, attractive built-in thermostat with precise temperature control handle and handle(s) for flow control.** / Velmi jednoduchá a krásná vestavěná termostatická baterie s kohoutkem pro přesnou teplotu a kohoutkem či kohoutky pro ovládání průtoku.

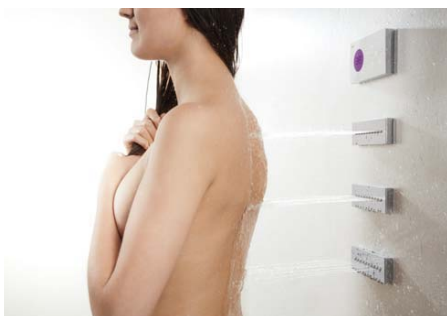
a pagina 108. / on page 108 / Na straně 108.
DA 2 A 4 VIE / 2 TO 4 OUTLET / 2 AŽ 4CESTNÝ

Shower technology®

Controllo elettronico termostatico che regola la temperatura e le differenti uscite dell'acqua digitalmente, con una sola pressione. / **Thermostatic electronic control that digitally regulates the temperature and different water outlets at a touch.** / Pomocí termostatického elektronického ovládání se teplota a jednotlivé výstupy vody regulují digitálně, jediným dotykem.

a pagina 160. / on page 160 / Na straně 160.
1 E 2 VIE / 1 AND 2 OUTLETS / 1 A 2CESTNÝ

Mono-term®

L'uso è come quello dei monocomandi, ma offre delle prestazioni simili a quelle di un gruppo termostatico. / **It is just as easy to operate as a mixer tap, but with features similar to those of a thermostatic tap.** / Ovládání je stejné jako v případě jednopákových baterií, ale s výkonem podobným termostatickým bateriím.

a pagina 192. / on page 192 / Na straně 192.
2 E 3 VIE / 2 AND 3 OUTLETS / 2 A 3CESTNÝ

Monocomandi / Mixer taps / Jednopákové baterie

Con il movimento di un solo comando, controlla la temperatura e il flusso, e il selettore di funzioni offre fino a tre uscite d'acqua. / **Use just one control to set the temperature and flow. The functions selector offers up to three water outlets.** / Pohybem jedné páky se ovládá teplota i proud a volič funkcí nabízí až tři výstupy vody.

a pagina 202. / on page 202 / Na straně 202.

BLOCK SYSTEM

Gruppi termostatici da incasso che fanno tendenza
Trend-setting built-in thermostatic taps
Vestavěné termostatické baterie, určující nový trend



Gruppo termostatico da incasso ad alto livello estetico. Viene fornito completamente montato e testato di fabbrica. / **Built-in thermostatic taps with a very attractive appearance. Supplied fully assembled and factory-tested.** / Vestavěná termostatická baterie s velkým estetickým dojmem. Dodává se zcela smontovaná a prověřená ve výrobě.

Cartucce deviatrici integrate da 1 a 4 vie. A partire da 3 vie, possibilità di usare due vie simultanee. / **Built-in cartridges with 1-4 outlets. In models with 3 or more outlets, the option of using two outlets simultaneously.** / Zabudované distribuční kartuše s 1 až 4 výstupy. U kartuší se 3 a více výstupy je možno použít dva výstupy současně.

Cartuccia termostatica tres instant 57 difficilmente ostruibile, alta durabilità e con protezione anticalcare. / **Tres instant 57 obstruction-proof cartridge with high durability and anti-limescale protection.** / Termostatický kartuš Tres instant 57 se jen těžko zanes, má dlouhou životnost a ochranu proti usazování vodního kamene.

Facile installazione e allineamento degli elementi. Se il controllo e il supporto doccia si comprano individualmente, possono essere allineati facilmente o installati separatamente. Le bocchette di idromassaggio (se ci sono) si possono allineare con il resto del corpo a incasso. Nei kit, il controllo e il supporto doccia sono integrati in un solo corpo incassato non divisibile. / **Simple installation and alignment of elements. If the shower head and support are purchased individually, they can be easily aligned or installed separately. The hydromassage jets (if any) are easy to align with the rest of the built-in unit. The head and shower supports are integrated in a single built-in unit in the kits.** / Snadná instalace a seřízení jednotlivých prvků. Pokud se ovládání a držák sprchy zakoupí jednotlivě, lze je snadno seřadit nebo nainstalovat zvlášť. Hydromasážní trysky (jsou-li přítomny) se snadno seřadí se zabudovaným tělesem. U sad je ovládání a sprchový držák zabudován do jednoho vestavného nerozdělitelného tělesa."



block system® horizontal

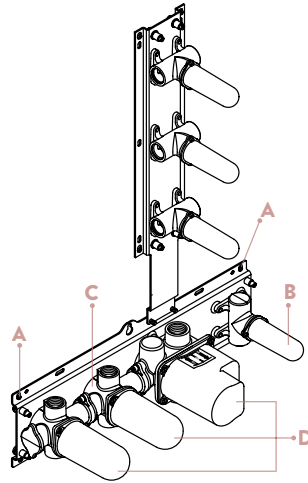

block system® vertical

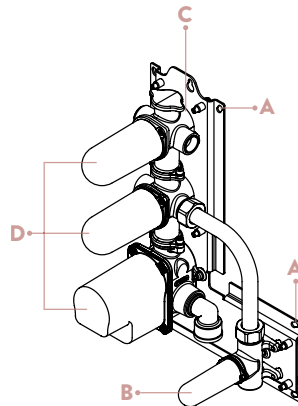

A Profilo di installazione a parete o cartongesso con 3 assi di livellamento.
Wall-mounted or plasterboard installation profile with 3 levelling axes.
Profil pro upevnění na zed' či sádkartone se 3 úrovněmi vyvážení.

B Supporto con attacco doccia integrato.
Base with built-in shower connection.
Nosník se sprchovým talířem je zahrnut.

C Ammortizzatori anti-vibrazione.
Anti-vibration shock absorbers.
Anti-vibrační tlumiče.

D Protettori a tenuta. La parete rimane protetta dall'umidità.
Water-tight protectors. The wall is protected from moisture.
Těsnící protektory. Stěna je dokonale chráněna proti vlhkosti.

TRES
BLOCK
SYSTEM



Ref. / Nr. / Kód:

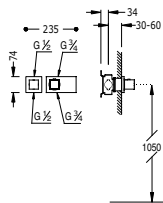

Termostatica ad incasso BLOCK SYSTEM

Con chiusura e regolazione di portata.

· Corpo incassato termostatico incluso.

* NOTA: è obbligatorio aggiungere all'ordine un soffione, doccia a mano, bocchette o una canna per vasca da bagno, a seconda del tipo di installazione.

Concealed thermostatic mixer BLOCK SYSTEM

with water shut off and flow control.

· Built-in thermostatic body included.

* NOTE: A spray nozzle, shower head, jet or bath spout must be added to the order, depending on installation type.

Termostatická podomítková baterie BLOCK SYSTEM

s uzavěrem a regulací průtoku.

· Včetně podomítkového termostatického tělesa.

* POZNÁMKA: Podle typu instalace je nutno přidat k objednávce krouptíko, ruční sprchu, trysky nebo ramínko na vanu.



299.250.45

1 via/way/cestné

Cr *207.251.99



299.250.45

2 vie/ways/cestná

Cr *207.252.99



1-2 VIE / WAYS / CESTNÁ

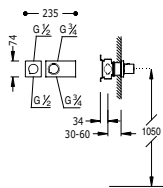

Termostatica ad incasso BLOCK SYSTEM

Con chiusura e regolazione di portata.

· Corpo incassato termostatico incluso.

* NOTA: è obbligatorio aggiungere all'ordine un soffione, doccia a mano, bocchette o una canna per vasca da bagno, a seconda del tipo di installazione.

Concealed thermostatic mixer BLOCK SYSTEM

with water shut off and flow control.

· Built-in thermostatic body included.

* NOTE: A spray nozzle, shower head, jet or bath spout must be added to the order, depending on installation type.

Termostatická podomítková baterie BLOCK SYSTEM

s uzavěrem a regulací průtoku.

· Včetně podomítkového termostatického tělesa.

* POZNÁMKA: Podle typu instalace je nutno přidat k objednávce krouptíko, ruční sprchu, trysky nebo ramínko na vanu.



299.195.03

1 via/way/cestné

Cr *207.351.99



299.195.03

2 vie/ways/cestná

Cr *207.352.99



Termostatica ad incasso BLOCK SYSTEM

Con chiusura e regolazione di portata.

- Corpo incassato termostatico incluso.

* **NOTA:** è obbligatorio aggiungere all'ordine un soffione, doccia a mano, bocchette o una canna per vasca da bagno, a seconda del tipo di installazione.

Concealed thermostatic mixer BLOCK SYSTEM

with water shut off and flow control.

- Built-in thermostatic body included.

* **NOTE:** A spray nozzle, shower head, jet or bath spout must be added to the order, depending on installation type.

Termostatická podomítková baterie BLOCK SYSTEM

s uzávěrem a regulací průtoku.

- Včetně podomítkového termostatického tělesa.

* **POZNÁMKA:** Podle typu instalace je nutno přidat k objednávce křípítko, ruční sprchu, trysky nebo ramínko na vanu.

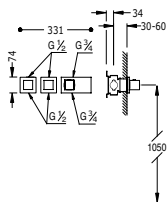

	299.250.45	3 vie/ways/cestná
Cr	*207.253.99	

	299.250.45	4 vie/ways/cestná
Cr	*207.254.99	



Termostatica ad incasso BLOCK SYSTEM

Con chiusura e regolazione di portata.

- Corpo incassato termostatico incluso.

* **NOTA:** è obbligatorio aggiungere all'ordine un soffione, doccia a mano, bocchette o una canna per vasca da bagno, a seconda del tipo di installazione.

Concealed thermostatic mixer BLOCK SYSTEM

with water shut off and flow control.

- Built-in thermostatic body included.

* **NOTE:** A spray nozzle, shower head, jet or bath spout must be added to the order, depending on installation type.

Termostatická podomítková baterie BLOCK SYSTEM

s uzávěrem a regulací průtoku.

- Včetně podomítkového termostatického tělesa.

* **POZNÁMKA:** Podle typu instalace je nutno přidat k objednávce křípítko, ruční sprchu, trysky nebo ramínko na vanu.

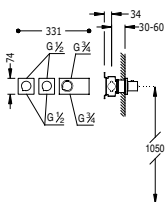

	299.195.03	3 vie/ways/cestná
Cr	*207.353.99	

	299.195.03	4 vie/ways/cestná
Cr	*207.354.99	



N

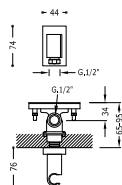

Supporto per doccia BLOCK SYSTEM

con presa d'acqua a parete con profondità regolabile e valvola antiritorno. Corpo incassato incluso.

Shower holder BLOCK SYSTEM

with adjustable depth wall water inlet fitting and anti-return valve. Built-in body included

Úchyt ruční sprchy se stěnovou přípojkou vody BLOCK SYSTEM

s nastavitelným výstupem pro vodu a zpětným ventilem. Včetně podomítkového tělesa.

Cr	207.182.02
----	------------



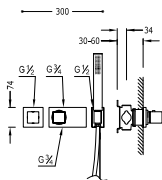

Termostatica ad incasso BLOCK SYSTEM

Con chiusura e regolazione di portata.

- Corpo incassato termostatico incluso.

- Doccetta anticalcare (202.639.01).

- Flessibile satin (91.34.609.15).

* NOTA: è obbligatorio aggiungere all'ordine una doccia a mano, bocchette o una canna per vasca da bagno, a seconda del tipo di installazione.

Concealed thermostatic mixer BLOCK SYSTEM

with water shut off and flow control.

- Built-in thermostatic body included.

- Antilime hand shower (202.639.01).

- Shower hose SATIN (91.34.609.15).

* NOTE: A shower head, jet or bath spout must be added to the order, depending on installation type.

Termostatická podomítková baterie BLOCK SYSTEM

s uzávěrem a regulací průtoku.

- Včetně podomítkového termostatického tělesa.

- Ruční sprcha, proti usaz. vod. kamene (202.639.01).

- Flexi hadice SATIN (91.34.609.15).

* POZNÁMKA: Podle typu instalace je nutno přidat k objednávce ruční sprchu, trysky nebo ramínko na vanu.



299.250.45

1 via/way/cestné

Cr 207.251.91



299.250.45

2 vie/ways/cestná

Cr *207.252.91

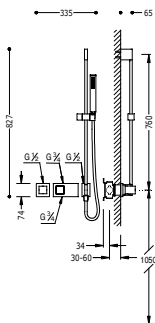

Termostatica ad incasso BLOCK SYSTEM

Con chiusura e regolazione di portata.

- Corpo incassato termostatico incluso.

- Barra di scorrimento con presa d'acqua a parete. Lung. 760 mm.

- Doccetta anticalcare (202.639.01).

- Flessibile satin (91.34.609.15).

* NOTA: è obbligatorio aggiungere all'ordine un soffione, bocchette o una canna per vasca da bagno, a seconda del tipo di installazione.

Concealed thermostatic mixer BLOCK SYSTEM

with water shut off and flow control.

- Built-in thermostatic body included.

- Sliding bar with wall water intake. Length: 760 mm.

- Antilime hand shower (202.639.01).

- Shower hose SATIN (91.34.609.15).

* NOTE: A shower head, jet or bath spout must be added to the order, depending on installation type.

Termostatická podomítková baterie BLOCK SYSTEM

s uzávěrem a regulací průtoku.

- Včetně podomítkového termostatického tělesa.

- Posuvná tyč s nástěnným přívodem vody. Délka 760 mm.

- Ruční sprcha, proti usaz. vod. kamene (202.639.01).

- Flexi hadice SATIN (91.34.609.15).

* POZNÁMKA: Podle typu instalace je nutno přidat k objednávce křepitko, trysky nebo ramínko na vanu.



299.250.45

1 via/way/cestné

Cr 207.251.92



299.250.45

2 vie/ways/cestná

Cr *207.252.92



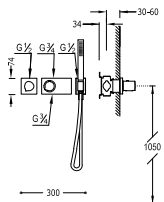

Termostatica ad incasso BLOCK SYSTEM

Con chiusura e regolazione di portata.

Corpo incassato termostatico incluso.

Doccetta anticalcare (034.116.01).

Flessibile satin (91.34.609.15).

* NOTA: è obbligatorio aggiungere all'ordine un soffione, bocchette o una canna per vasca da bagno, a seconda del tipo di installazione.

Concealed thermostatic mixer BLOCK SYSTEM

with water shut off and flow control.

Built-in thermostatic body included.

Antilime hand shower (034.116.01).

Shower hose SATIN (91.34.609.15).

* NOTE: A shower head, jet or bath spout must be added to the order, depending on installation type.

Termostatická podomítková baterie BLOCK SYSTEM

s uzávěrem a regulací průtoku.

Včetně podomítkového termostatického tělesa.

Ruční sprcha, proti usaz. vod. kamene (034.116.01).

Flexi hadice SATIN (91.34.609.15).

* POZNÁMKA: Podle typu instalace je nutno přidat k objednávce křípítko, trysky nebo ramínko na vanu.



299.195.03

1 via/way/cestdné

Cr | **207.351.91** |



299.195.03

2 vie/ways/cestdná

Cr | ***207.352.91** |

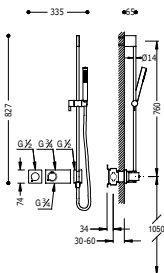

Termostatica ad incasso BLOCK SYSTEM

Con chiusura e regolazione di portata.

Corpo incassato termostatico incluso.

Barra di scorrimento con presa d'acqua a parete. Lung. 760 mm.

Doccetta anticalcare (034.116.01).

Flessibile satin (91.34.609.15).

* NOTA: è obbligatorio aggiungere all'ordine un soffione, bocchette o una canna per vasca da bagno, a seconda del tipo di installazione.

Concealed thermostatic mixer BLOCK SYSTEM

with water shut off and flow control.

Built-in thermostatic body included.

Sliding bar with wall water intake. Length: 760 mm.

Antilime hand shower (034.116.01).

Shower hose SATIN (91.34.609.15).

* NOTE: A shower head, jet or bath spout must be added to the order, depending on installation type.

Termostatická podomítková baterie BLOCK SYSTEM

s uzávěrem a regulací průtoku.

Včetně podomítkového termostatického tělesa.

Posuvná tyč s nástěnným přívodem vody. Délka 760 mm.

Ruční sprcha, proti usaz. vod. kamene (034.116.01).

Flexi hadice SATIN (91.34.609.15).

* POZNÁMKA: Podle typu instalace je nutno přidat k objednávce křípítko, trysky nebo ramínko na vanu.



299.195.03

1 via/way/cestdné

Cr | **207.351.92** |



299.195.03

2 vie/ways/cestdná

Cr | ***207.352.92** |





Kit doccia termostatica ad incasso BLOCK SYSTEM

- Con chiusura e regolazione di portata (2 vie).
- Corpo incassato termostatico incluso.
- Doccia fissa 300x300 mm. con snodo (1.34.138.30). Ottone.
- Doccetta anticalcare (202.639.01).
- Flexibile satin (91.34.609.15).

Concealed thermostatic shower kit BLOCK SYSTEM with water shut off and flow control (2 ways).

- Built-in thermostatic body included.
- Fixed shower head 300x300 mm. with ball joint (1.34.138.30).

Brass.

- Antilime hand shower (202.639.01).
- Shower hose SATIN (91.34.609.15).

Termostatický podmítkový sprchový set BLOCK SYSTEM

- s uzávěrem a regulací průtoku (2-cestná).
- Včetně podmítkového termostatického tělesa.
- Pevná sprcha 300x300 mm. s kloubem. Materiál mosaz (1.34.138.30).
- Ruční sprcha, proti usaz. vod. kamene (202.639.01).
- Flexi hadice SATIN (91.34.609.15).

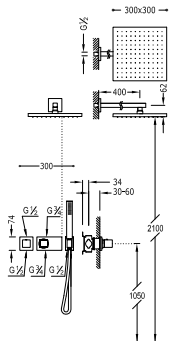

299.250.45

Cr 207.252.01



Kit doccia termostatica ad incasso BLOCK SYSTEM

- Con chiusura e regolazione di portata (2 vie).
- Corpo incassato termostatico incluso.
- Doccia acciaio inossidabile da parete 210x550 mm. (299.903.02).
- Doccetta anticalcare (202.639.01).
- Flexibile satin (91.34.609.15).

Concealed thermostatic shower kit BLOCK SYSTEM with water shut off and flow control (2 ways).

- Built-in thermostatic body included.
- Stainless steel wall shower 210x550 mm. (299.903.02).
- Antilime hand shower (202.639.01).
- Shower hose SATIN (91.34.609.15).

Termostatický podmítkový sprchový set BLOCK SYSTEM

- s uzávěrem a regulací průtoku (2-cestná).
- Včetně podmítkového termostatického tělesa.
- Nástěnné sprchové křepitko z nerez. oceli 210x550 mm. (299.903.02).
- Ruční sprcha, proti usaz. vod. kamene (202.639.01).
- Flexi hadice SATIN (91.34.609.15).

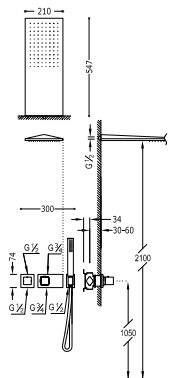

299.250.45

Cr 207.252.02

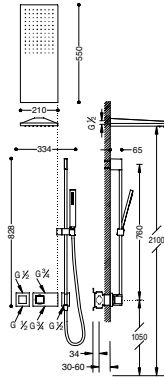

Kit doccia termostatica ad incasso BLOCK SYSTEM

- Con chiusura e regolazione di portata (2 vie).
- Corpo incassato termostatico incluso.
- Doccia acciaio inossidabile da parete 210x550 mm. (299.903.02).
- Barra di scorrimento con presa d'acqua a parete. Lung. 760 mm
- Doccetta anticalcare (202.639.01).
- Flessibile satin (91.34.609.15).

Concealed thermostatic shower kit BLOCK SYSTEM with water shut off and flow control (2 ways).

- Built-in thermostatic body included.
- Stainless steel wall shower 210x550 mm. (299.903.02).
- Sliding bar with wall water intake. Length: 760 mm.
- Antilime hand shower (202.639.01).
- Shower hose SATIN (91.34.609.15).

Termostatický podomítkový sprchový set BLOCK SYSTEM s uzávěrem a regulací průtoku (2 cestná).

- Včetně podomítkového termostatického tělesa.
- Nástěnné sprchové křepitko z nerez. oceli 210x550 mm. (299.903.02).
- Posuvná tyč s nástěnným přívodem vody. Délka 760 mm.
- Ruční sprcha, proti usaz. vod. kamene (202.639.01).
- Flexi hadice SATIN (91.34.609.15).

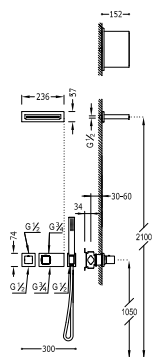

Kit doccia termostatica ad incasso BLOCK SYSTEM

- Con chiusura e regolazione di portata (2 vie).
- Corpo incassato termostatico incluso.
- Tubo cascata vasca acciaio inossidabile (299.903.04).
- Doccetta anticalcare (202.639.01).
- Flessibile satin (91.34.609.15).

Concealed thermostatic shower kit BLOCK SYSTEM with water shut off and flow control (2 ways).

- Built-in thermostatic body included.
- Steel cascade cast spout (299.903.04).
- Antilime hand shower (202.639.01).
- Shower hose SATIN (91.34.609.15).

Termostatický podomítkový sprchový set BLOCK SYSTEM s uzávěrem a regulací průtoku (2-cestná).

- Včetně podomítkového termostatického tělesa.
- Ramínko s kaskádou z nerez. oceli (299.903.04).
- Ruční sprcha, proti usaz. vod. kamene (202.639.01).
- Flexi hadice SATIN (91.34.609.15).

ECO TRES BLOCK SYSTEM TRES INSTANT 57 easy clean 299.250.45 Cr | 207.252.10

ECO TRES BLOCK SYSTEM TRES INSTANT 57 easy clean 299.250.45 Cr | 207.252.03

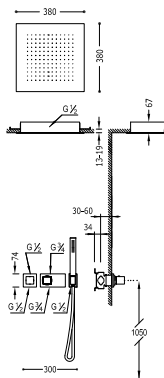
**Kit doccia termostatica ad incasso BLOCK SYSTEM**

- Con chiusura e regolazione di portata (2 vie).
- Corpo incassato termostatico incluso.
- Soffione doccia acciaio inossidabile 380x380 mm. (1.34.944).
- Doccetta anticalcare (202.639.01).
- Flexibile satin (91.34.609.15).

Concealed thermostatic shower kit BLOCK SYSTEM with water shut off and flow control (2 ways).

- Built-in thermostatic body included.
- Stainless steel ceiling shower 380x380 mm. (1.34.944).
- Antilime hand shower (202.639.01).
- Shower hose SATIN (91.34.609.15).

Termostatický podomítkový sprchový set BLOCK SYSTEM s uzávěrem a regulací průtoku (2-cestná).

- Včetně podomítkového termostatického tělesa.
- Sprchové křepítko z nerez. oceli 380x380 mm. (1.34.944).
- Ruční sprcha, proti usaz. vod. kamene (202.639.01).
- Flexi hadice SATIN (91.34.609.15).

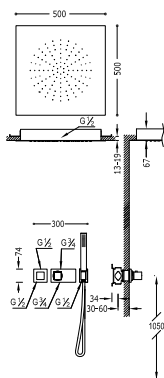
**Kit doccia termostatica ad incasso BLOCK SYSTEM**

- Con chiusura e regolazione di portata (2 vie).
- Corpo incassato termostatico incluso.
- Soffione doccia acciaio inossidabile 500x500 mm. (299.953.02).
- Doccetta anticalcare (202.639.01).
- Flexibile satin (91.34.609.15).

Concealed thermostatic shower kit BLOCK SYSTEM with water shut off and flow control (2 ways).

- Built-in thermostatic body included.
- Stainless steel ceiling shower 500x500 mm. (299.953.02).
- Antilime hand shower (202.639.01).
- Shower hose SATIN (91.34.609.15).

Termostatický podomítkový sprchový set BLOCK SYSTEM s uzávěrem a regulací průtoku (2-cestná).

- Včetně podomítkového termostatického tělesa.
- Sprchové křepítko z nerez. oceli 500x500 mm. (299.953.02).
- Ruční sprcha, proti usaz. vod. kamene (202.639.01).
- Flexi hadice SATIN (91.34.609.15).





Kit doccia termostatica ad incasso BLOCK SYSTEM

- Con chiusura e regolazione di portata (2 vie).
- Corpo incassato termostatico incluso.
- Soffione doccia acciaio inossidabile 500x500 mm. (299.953.02).
- Barra di scorrimento con presa d'acqua a parete. Lung. 760 mm.
- Doccetta anticalcare (202.639.01).
- Flessibile satin (91.34.609.15).

Concealed thermostatic shower kit BLOCK SYSTEM with water shut off and flow control (2 ways).

- Built-in thermostatic body included.
- Stainless steel ceiling shower 500x500 mm. (299.953.02).
- Sliding bar with wall water intake. Length: 760 mm.
- Antilime hand shower (202.639.01).
- Shower hose SATIN (91.34.609.15).

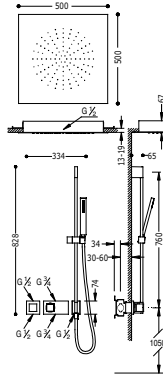

Termostatický podomítkový sprchový set BLOCK SYSTEM s uzavěrem a regulací průtoku (2-cestná).

- Včetně podomítkového termostatického tělesa.
- Sprchové křepitko z nerez. oceli 500x500 mm. (299.953.02).
- Posuvná tyč s nástěnným přívodem vody. Délka 760 mm.
- Ruční sprcha, proti usaz. vod. kamene (202.639.01).
- Flexi hadice SATIN (91.34.609.15).



Kit doccia termostatica ad incasso BLOCK SYSTEM CHROMOTHERAPY

- Con chiusura e regolazione di portata (2 vie).
- Corpo incassato termostatico incluso.
- Soffione doccia acciaio inossidabile 500x500 mm. (299.962.01).
- Doccetta anticalcare (202.639.01).
- Flessibile satin (91.34.609.15).

Concealed thermostatic shower kit BLOCK SYSTEM CHROMOTHERAPY with water shut off and flow control (2 ways).

- Built-in thermostatic body included.
- Stainless steel ceiling shower 500x500 mm. (299.962.01).
- Antilime hand shower (202.639.01).
- Shower hose SATIN (91.34.609.15).

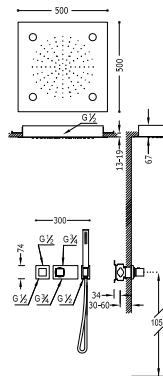

Termostatický podomítkový sprchový set BLOCK SYSTEM CHROMOTHERAPY s uzavěrem a regulací průtoku (2-cestná).

- Včetně podomítkového termostatického tělesa.
- Sprchové křepitko z nerez. oceli 500x500 mm. (299.962.01).
- Ruční sprcha, proti usaz. vod. kamene (202.639.01).
- Flexi hadice SATIN (91.34.609.15).



**Kit termostatico vasca ad incasso BLOCK SYSTEM**

- Con chiusura e regolazione di portata (2 vie).
 - Corpo incassato termostatico incluso.
 - Tubo cascata vasca acciaio inossidabile.
 - Doccetta anticalcare (202.639.01).
 - Flessibile satin (91.34.609.15).

Concealed thermostatic bath kit BLOCK SYSTEM

- with water shut off and flow control (2 ways).
 - Built-in thermostatic body included.
 - Steel cascade cast spout.
 - Antilime hand shower (202.639.01).
 - Shower hose SATIN (91.34.609.15).

Termostatický podomítkový vanový set BLOCK SYSTEM

- s uzávěrem a regulací průtoku (2-cestná).
 - Včetně podomítkového termostatického tělesa.
 - Vanové ramínko s kaskádou z nerez. oceli.
 - Ruční sprcha proti usaz. vod. kamene (202.639.01).
 - Flexi hadice SATIN (91.34.609.15).

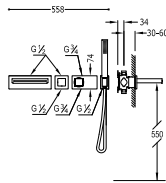

299.250.45

Cr 207.192.01

Kit termostatico vasca ad incasso BLOCK SYSTEM

- Con chiusura e regolazione di portata (2 vie).
 - Corpo incassato termostatico incluso.
 - Scarico vasca e valvola di riempimento quadrata A CASCATA con troppopieno. (1.34.534.40).
 - Sifone PVC vasca (1.34.634.60).
 - Doccetta anticalcare (202.639.01).
 - Flessibile satin (91.34.609).

Concealed thermostatic bath kit BLOCK SYSTEM

- with water shut off and flow control (2 ways).
 - Built-in thermostatic body included.
 - Bath drain and square CASCADE filling valve with overflow drain (1.34.534.40).
 - Bath PVC drain trap (1.34.634.60).
 - Antilime hand shower (202.639.01).
 - Shower hose SATIN (91.34.609).

Termostatický podomítkový vanový set BLOCK SYSTEM

- s uzávěrem a regulací průtoku (2-cestná).
 - Včetně podomítkového termostatického tělesa.
 - Odtoková a napouštěcí vanová hranatá KASKÁDA s přepadem (1.34.534.40).
 - Vanový sifon z PVC (1.34.634.60).
 - Ruční sprcha, proti usaz. vod. kamene (202.639.01).
 - Flexi hadice SATIN (91.34.609).

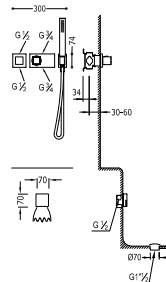

299.250.45

Cr 207.252.06

Kit termostatico vasca ad incasso BLOCK SYSTEM

Con chiusura e regolazione di portata (2 vie).

- Corpi incassato termostatico incluso.
- Scarico vasca e valvola di riempimento quadrata A CASCATA con troppopieno (1.34.534.40).
- Sifone PVC vasca (1.34.634.60).
- Doccetta anticalcare (202.639.01).
- Flessibile doppia graffatura.

Concealed thermostatic bath kit BLOCK SYSTEM

with water shut off and flow control (2 ways).

- Built-in thermostatic body included.
- Bath drain and square CASCADE filling valve with overflow drain (1.34.534.40).
- Bath PVC drain trap (1.34.634.60).
- Antilime hand shower (202.639.01).
- Double interlocked shower hose.

Termostatický podomítkový vanový set BLOCK SYSTEM

s uzávěrem a regulací průtoku (2-cestná).

- Včetně podomítkového termostatického tělesa.
- Odtoková a napouštěcí vanová hranatá KASKÁDA s přepadem (1.34.534.40).
- Vanový sifon z PVC (1.34.634.60).
- Ruční sprcha, proti usaz. vod. kamene (202.639.01).
- Flexi hadice s dvojitým opletem.

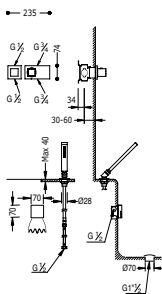

299.250.45

Cr | 207.252.07

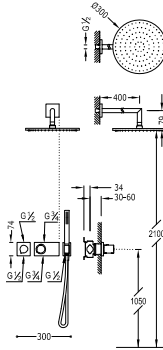

**Kit doccia termostatica ad incasso BLOCK SYSTEM**

Con chiusura e regolazione di portata (2 vie).

- Corpo incassato termostatico incluso.
- Doccia fissa Ø 300 mm. con snodo. Ottone (1.34.137.30).
- Doccetta anticalcare (034.116.01).
- Flessibile satin (91.34.609.15).

Concealed thermostatic shower kit BLOCK SYSTEM

with water shut off and flow control (2 ways).

- Built-in thermostatic body included.
- Fixed shower head Ø 300 mm. with ball joint. Brass (1.34.137.30).
- Antilime hand shower (034.116.01).
- Shower hose SATIN (91.34.609.15).

Termostatický podomítkový sprchový set BLOCK SYSTEM s uzávěrem a regulací průtoku (2-cestná).

- Včetně podomítkového termostatického tělesa.
- Pevná sprcha Ø 300 mm. s kloubem. Materiál Mosaz (1.34.137.30).
- Ruční sprcha, proti usaz. vod. kamene (034.116.01).
- Flexi hadice SATIN (91.34.609.15).

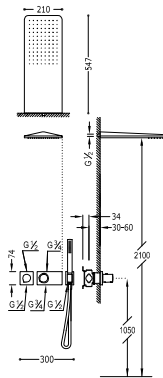
**Kit doccia termostatica ad incasso BLOCK SYSTEM**

Con chiusura e regolazione di portata (2 vie).

- Corpo incassato termostatico incluso.
- Doccia acciaio inossidabile da parete 210x550 mm. (299.903.07).
- Doccetta anticalcare (034.116.01).
- Flessibile satin (91.34.609.15).

Concealed thermostatic shower kit BLOCK SYSTEM

with water shut off and flow control (2 ways).

- Built-in thermostatic body included.
- Stainless steel wall shower 210x550 mm. (299.903.07).
- Antilime hand shower (034.116.01).
- Shower hose SATIN (91.34.609.15).

Termostatický podomítkový sprchový set BLOCK SYSTEM s uzávěrem a regulací průtoku (2-cestná).

- Včetně podomítkového termostatického tělesa.
- Nástěnné sprchové křepitko z nerez. oceli 210x550 mm. (299.903.07).
- Ruční sprcha, proti usaz. vod. kamene (034.116.01).
- Flexi hadice SATIN (91.34.609.15).



Cr 207.352.01



Cr 207.352.02

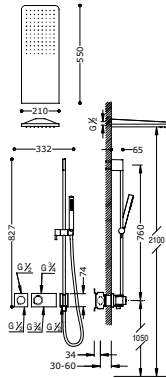

Kit doccia termostatica ad incasso BLOCK SYSTEM

- Con chiusura e regolazione di portata (2 vie).
- Corpo incassato termostatico incluso.
- Doccia acciaio inossidabile da parete 210x550 mm. (299.903.07).
- Barra di scorrimento con presa d'acqua a parete. Lung. 760 mm
- Doccetta anticalcare (034.116.01).
- Flexibile satin (91.34.609.15).

Concealed thermostatic shower kit BLOCK SYSTEM with water shut off and flow control (2 ways).

- Built-in thermostatic body included.
- Stainless steel wall shower 210x550 mm. (299.903.07).
- Sliding bar with wall water intake. Length: 760 mm.
- Antilime hand shower (034.116.01).
- Shower hose SATIN (91.34.609.15).

Termostatický podomítkový sprchový set BLOCK SYSTEM s uzávěrem a regulací průtoku (2-cestná).

- Včetně podomítkového termostatického tělesa.
- Nástěnné sprchové křepitko z nerez. oceli 210x550 mm. (299.903.07).
- Posuvná tyč s nástěnným přívodem vody. Délka 760 mm.
- Ruční sprcha, proti usaz. vod. kamene (034.116.01).
- Flexi hadice SATIN (91.34.609.15).

299.195.03
Cr | **207.352.10**

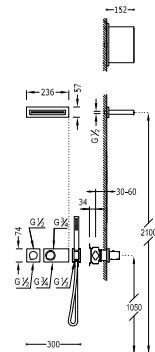

Kit doccia termostatica ad incasso BLOCK SYSTEM

- Con chiusura e regolazione di portata (2 vie).
- Corpo incassato termostatico incluso.
- Tubo cascata vasca acciaio inossidabile (299.903.04).
- Doccetta anticalcare (034.116.01).
- Flexibile satin (91.34.609.15).

Concealed thermostatic shower kit BLOCK SYSTEM with water shut off and flow control (2 ways).

- Built-in thermostatic body included.
- Steel cascade cast spout (299.903.04).
- Antilime hand shower (034.116.01).
- Shower hose SATIN (91.34.609.15).

Termostatický podomítkový sprchový set BLOCK SYSTEM s uzávěrem a regulací průtoku (2-cestná).

- Včetně podomítkového termostatického tělesa.
- Ramínko s kaskádou z nerez. oceli (299.903.04).
- Ruční sprcha, proti usaz. vod. kamene (034.116.01).
- Flexi hadice SATIN (91.34.609.15).

299.195.03
Cr | **207.352.03**

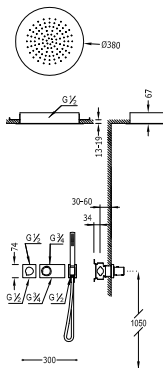
**Kit doccia termostatica ad incasso BLOCK SYSTEM**

- Con chiusura e regolazione di portata (2 vie).
 - Corpo incassato termostatico incluso.
 - Soffione doccia acciaio inossidabile Ø 380 mm. (1.34.940).
 - Doccetta anticalcare (034.116.01).
 - Flessibile satin (91.34.609.15).

Concealed thermostatic shower kit BLOCK SYSTEM with water shut off and flow control (2 ways).

- Built-in thermostatic body included.
 - Stainless steel ceiling shower Ø 380 mm. (1.34.940).
 - Antilime hand shower (034.116.01).
 - Shower hose SATIN (91.34.609.15).

Termostatický podomítkový sprchový set BLOCK SYSTEM s uzávěrem a regulací průtoku (2-cestná).

- Včetně podomítkového termostatického tělesa.
 - Sprchové křepítko z nerez. oceli Ø 380 mm. (1.34.940).
 - Ruční sprcha, proti usaz. vod. kamene (034.116.01).
 - Flexi hadice SATIN (91.34.609.15).

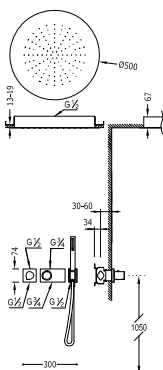
**Kit doccia termostatica ad incasso BLOCK SYSTEM**

- Con chiusura e regolazione di portata (2 vie).
 - Corpo incassato termostatico incluso.
 - Soffione doccia acciaio inossidabile Ø 500 mm. (1.34.950).
 - Doccetta anticalcare (034.116.01).
 - Flessibile satin (91.34.609.15).

Concealed thermostatic shower kit BLOCK SYSTEM with water shut off and flow control (2 ways).

- Built-in thermostatic body included.
 - Stainless steel ceiling shower Ø 500 mm. (1.34.950).
 - Antilime hand shower (034.116.01).
 - Shower hose SATIN (91.34.609.15).

Termostatický podomítkový sprchový set BLOCK SYSTEM s uzávěrem a regulací průtoku (2-cestná).

- Včetně podomítkového termostatického tělesa.
 - Sprchové křepítko z nerez. oceli Ø 500 mm. (1.34.950).
 - Ruční sprcha, proti usaz. vod. kamene (034.116.01).
 - Flexi hadice SATIN (91.34.609.15).



299.195.03

Cr 207.352.04



299.195.03

Cr 207.352.11



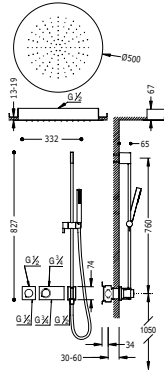

Kit doccia termostatica ad incasso BLOCK SYSTEM

- Con chiusura e regolazione di portata (2 vie).
- Corpo incassato termostatico incluso.
- Soffione doccia acciaio inossidabile Ø 500 mm. (1.34.950).
- Barra di scorrimento con presa d'acqua a parete. Lung. 760 mm
- Doccetta anticalcare (034.116.01).
- Flessibile satin (91.34.609.15).

Concealed thermostatic shower kit BLOCK SYSTEM with water shut off and flow control (2 ways).

- Built-in thermostatic body included.
- Stainless steel ceiling shower Ø 500 mm. (1.34.950).
- Sliding bar with wall water intake. Length: 760 mm.
- Antilime hand shower (034.116.01).
- Shower hose SATIN (91.34.609.15).

Termostatický podomítkový sprchový set BLOCK SYSTEM s uzávěrem a regulací průtoku (2-cestná).

- Včetně podomítkového termostatického tělesa.
- Sprchové křepítko z nerez. oceli Ø 500 mm. (1.34.950).
- Posuvná tyč s nástěnným přívodem vody. Délka 760 mm.
- Ruční sprcha, proti usaz. vod. kamene (034.116.01).
- Flexi hadice SATIN (91.34.609.15).

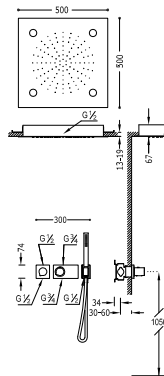

Kit doccia termostatica ad incasso BLOCK SYSTEM CHROMOTHERAPY

- Con chiusura e regolazione di portata (2 vie).
- Corpo incassato termostatico incluso.
- Soffione doccia acciaio inossidabile 500x500 mm. (299.962.01).
- Doccetta anticalcare (034.116.01).
- Flessibile satin (91.34.609.15).

Concealed thermostatic shower kit BLOCK SYSTEM CHROMOTHERAPY

- with water shut off and flow control (2 ways).
- Built-in thermostatic body included.
- Stainless steel ceiling shower 500x500 mm. (299.962.01).
- Antilime hand shower (034.116.01).
- Shower hose SATIN (91.34.609.15).

Termostatický podomítkový sprchový set BLOCK SYSTEM CHROMOTHERAPY

- s uzávěrem a regulací průtoku (2-cestná).
- Včetně podomítkového termostatického tělesa.
- Sprchové křepítko z nerez. oceli 500x500 mm. (299.962.01).
- Ruční sprcha, proti usaz. vod. kamene (034.116.01).
- Flexi hadice SATIN (91.34.609.15).



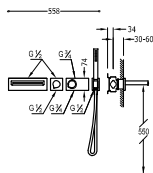

Kit termostatico vasca ad incasso BLOCK SYSTEM

Con chiusura e regolazione di portata (2 vie).

- Corpo incassato termostatico incluso.
- Tubo cascata vasca acciaio inossidabile.
- Doccetta anticalcare (034.116.01).
- Flessibile satin (91.34.609.15).

Concealed thermostatic bath kit BLOCK SYSTEM

with water shut off and flow control (2 ways).

- Built-in thermostatic body included.
- Steel cascade cast spout.
- Antilime hand shower (034.116.01).
- Shower hose SATIN (91.34.609.15).

Termostatický podomítkový vanový set BLOCK SYSTEM

s uzávěrem a regulací průtoku (2-cestná).

- Včetně podomítkového termostatického tělesa.
- Vanové ramínko s kaskádou z nerez. oceli.
- Ruční sprcha, proti usaz. vod. kamene (034.116.01).
- Flexi hadice SATIN (91.34.609.15).



299.195.03

Cr 207.392.01

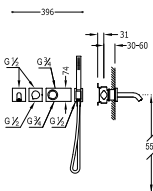

Kit termostatico vasca ad incasso BLOCK SYSTEM

Con chiusura e regolazione di portata (2 vie).

- Corpo incassato termostatico incluso.
- Cannà per vasca da bagno.
- Doccetta anticalcare (034.116.01).
- Flessibile satin (91.34.609.15).

Concealed thermostatic bath kit BLOCK SYSTEM

with water shut off and flow control (2 ways).

- Built-in thermostatic body included.
- Bath spout.
- Antilime hand shower (034.116.01).
- Shower hose SATIN (91.34.609.15).

Termostatický podomítkový vanový set BLOCK SYSTEM

s uzávěrem a regulací průtoku (2-cestná).

- Včetně podomítkového termostatického tělesa.
- Kohoutek pro vanu.
- Ruční sprcha, proti usaz. vod. kamene (034.116.01).
- Flexi hadice SATIN (91.34.609.15).



299.195.03

Cr 207.352.09

Kit termostatico vasca ad incasso BLOCK SYSTEM

Con chiusura e regolazione di portata (2 vie).

- Corpo incassato termostatico incluso.
- Canna per vasca da bagno.
- Doccetta anticalcare (034.116.01).
- Flessibile satin (91.34.609.15).

Concealed thermostatic bath kit BLOCK SYSTEM

with water shut off and flow control (2 ways).

- Built-in thermostatic body included.
- Bath spout.
- Antilime hand shower (034.116.01).
- Shower hose SATIN (91.34.609.15).

Termostatický podomítkový vanový set BLOCK SYSTEM

s uzávěrem a regulací průtoku (2-cestná).

- Včetně podomítkového termostatického tělesa.
- Kohoutek pro vanu.
- Ruční sprcha, proti usaz. vod. kamene (034.116.01).
- Flexi hadice SATIN (91.34.609.15).

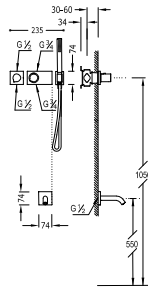

299.195.03

 Cr | **207.352.08** |

Kit termostatico vasca ad incasso BLOCK SYSTEM

Con chiusura e regolazione di portata (2 vie).

- Corpo incassato termostatico incluso.
- Scarico vasca e valvola di riempimento rotonda A CASCATA con troppopieno (1.34.534.30).
- Sifone PVC vasca (1.34.634.60).
- Doccetta anticalcare (034.116.01).
- Flessibile satin (91.34.609).

Concealed thermostatic bath kit BLOCK SYSTEM

with water shut off and flow control (2 ways).

- Built-in thermostatic body included.
- Bath drain and round CASCADE filling valve with overflow drain (1.34.534.30).
- Bath PVC drain trap (1.34.634.60).
- Antilime hand shower (034.116.01).
- Shower hose SATIN (91.34.609).

Termostatický podomítkový vanový set BLOCK SYSTEM

s uzávěrem a regulací průtoku (2-cestná).

- Včetně podomítkového termostatického tělesa.
- Odtoková a napouštěcí vanová kulatá KASKÁDA s přepadem (1.34.534.30).
- Vanový sifon z PVC (1.34.634.60).
- Ruční sprcha, proti usaz. vod. kamene (034.116.01).
- Flexi hadice SATIN (91.34.609).

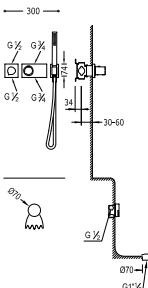

299.195.03

 Cr | **207.352.06** |

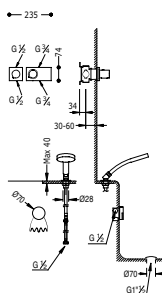

Kit termostatico vasca ad incasso BLOCK SYSTEM

- Con chiusura e regolazione di portata (2 vie).
- Corpo incassato termostatico incluso.
- Scarico vasca e valvola di riempimento rotonda A CASCATA con troppopieno (1.34.534.30).
- Sifone PVC vasca (1.34.634.60).
- Doccetta massaggio, 5 posizioni (299.631.06).
- Flessibile doppia graffiatura.

Concealed thermostatic bath kit BLOCK SYSTEM

- with water shut off and flow control (2 ways).
- Built-in thermostatic body included.
- Bath drain and round CASCADE filling valve with overflow drain (1.34.534.30).
- Bath PVC drain trap (1.34.634.60).
- Massage shower, 5 positions (299.631.06).
- Double interlocked shower hose.

Termostatický podomítkový vanový set BLOCK SYSTEM

- s uzávěrem a regulací průtoku (2-cestná).
- Včetně podomítkového termostatického tělesa.
- Odtoková a napouštěcí vanová kulatá KASKÁDA s přepadem (1.34.534.30).
- Vanový sifon z PVC (1.34.634.60).
- Masážní sprcha, 5 funkcí (299.631.06).
- Flexi hadice s dvojitým opletem.



209.195.03

Cr 207.352.07

Termostatica ad incasso BLOCK SYSTEM

- Con chiusura e regolazione di portata.
- Corpo incassato termostatico incluso.
- Doccetta anticalcare (202.639.01).
- Flessibile satin (91.34.609.15).

NOTA: è obbligatorio aggiungere all'ordine un soffione, bocchette o una canna per vasca da bagno, a seconda del tipo di installazione.

Concealed thermostatic mixer BLOCK SYSTEM

with water shut off and flow control.

- Built-in thermostatic body included.
- Antilime hand shower (202.639.01).
- Shower hose SATIN (91.34.609.15).

NOTE: A shower head, jet or bath spout must be added to the order, depending on installation type.

Termostatická podomítková baterie BLOCK SYSTEM

s uzávěrem a regulací průtoku.

- Včetně podomítkového termostatického tělesa.
- Ruční sprcha, proti usaz. vod. kamene (202.639.01).
- Flexi hadice SATIN (91.34.609.15).

POZNÁMKA: Podle typu instalace je nutno přidat k objednávce křepítka, trysky nebo ramínko na vanu.

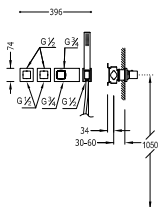

299.250.45

3 vie/ways/cestná

Cr | 207.253.91 |



299.250.45

4 vie/ways/cestná

Cr | 207.254.91 |



Termostatica ad incasso BLOCK SYSTEM

Con chiusura e regolazione di portata.

- Corpo incassato termostatico incluso.
- Barra di scorrimento con presa d'acqua a parete. Lung. 760 mm.
- Doccetta anticalcare (202.639.01).
- Flessibile satin (91.34.609.15).

NOTA: è obbligatorio aggiungere all'ordine un soffione, bocchette o una canna per vasca da bagno, a seconda del tipo di installazione.

Concealed thermostatic mixer BLOCK SYSTEM

with water shut off and flow control.

- Built-in thermostatic body included.
- Sliding bar with wall water intake. Length: 760 mm.
- Antilime hand shower (202.639.01).
- Shower hose SATIN (91.34.609.15).

NOTE: A shower head, jet or bath spout must be added to the order, depending on installation type.

Termostatická podomítková baterie BLOCK SYSTEM

s uzávěrem a regulací průtoku.

- Včetně podomítkového termostatického tělesa.
- Posuvná tyč s nástěnným přívodem vody. Délka 760 mm.
- Ruční sprcha, proti usaz. vod. kamene (202.639.01).
- Flexi hadice SATIN (91.34.609.15).

POZNÁMKA: Podle typu instalace je nutno přidat k objednávce křepítka, trysky nebo ramínko na vanu.

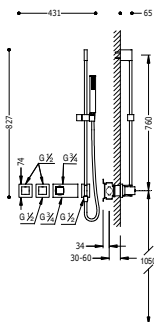

299.250.45

3 vie/ways/cestná

Cr | 207.253.92 |



299.250.45

4 vie/ways/cestná

Cr | 207.254.92 |

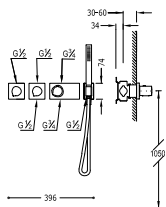

**Termostatica ad incasso BLOCK SYSTEM**

- Con chiusura e regolazione di portata.
- Corpo incassato termostatico incluso.
- Doccetta anticalcare (034.116.01).
- Flessibile satin (91.34.609.15).

NOTA: è obbligatorio aggiungere all'ordine un soffione, bocchette o una canna per vasca da bagno, a seconda del tipo di installazione.

Concealed thermostatic mixer BLOCK SYSTEM

- with water shut off and flow control.
 - Built-in thermostatic body included.
 - Antilime hand shower (034.116.01).
 - Shower hose SATIN (91.34.609.15).
- NOTE: A shower head, jet or bath spout must be added to the order, depending on installation type.

Termostatická podomítková baterie BLOCK SYSTEM

- s uzávěrem a regulací průtoku.
 - Včetně podomítkového termostatického tělesa.
 - Ruční sprcha, proti usaz. vod. kamene (034.116.01).
 - Flexi hadice SATIN (91.34.609.15).
- POZNÁMKA: Podle typu instalace je nutno přidat k objednávce kropítko, trysky nebo ramínko na vanu.



299.195.03

3 vie/ways/cestná

Cr | 207.353.91 |



299.195.03

4 vie/ways/cestná

Cr | 207.354.91 |

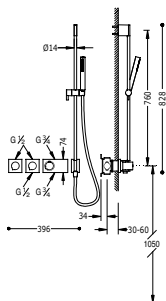
**Termostatica ad incasso BLOCK SYSTEM**

- Con chiusura e regolazione di portata.
- Corpo incassato termostatico incluso.
- Barra di scorrimento con presa d'acqua a parete. Lung. 760 mm.
- Doccetta anticalcare (034.116.01).
- Flessibile satin (91.34.609.15).

NOTA: è obbligatorio aggiungere all'ordine un soffione, bocchette o una canna per vasca da bagno, a seconda del tipo di installazione.

Concealed thermostatic mixer BLOCK SYSTEM

- with water shut off and flow control.
 - Built-in thermostatic body included.
 - Sliding bar with wall water intake. Length: 760 mm.
 - Antilime hand shower (034.116.01).
 - Shower hose SATIN (91.34.609.15).
- NOTE: A shower head, jet or bath spout must be added to the order, depending on installation type.

Termostatická podomítková baterie BLOCK SYSTEM

- s uzávěrem a regulací průtoku.
 - Včetně podomítkového termostatického tělesa.
 - Posuvná tyč s nástěnným přívodem vody. Délka 760 mm.
 - Ruční sprcha, proti usaz. vod. kamene (034.116.01).
 - Flexi hadice SATIN (91.34.609.15).
- POZNÁMKA: Podle typu instalace je nutno přidat k objednávce kropítko, trysky nebo ramínko na vanu.



299.195.03

3 vie/ways/cestná

Cr | 207.353.92 |



299.195.03

4 vie/ways/cestná

Cr | 207.354.92 |



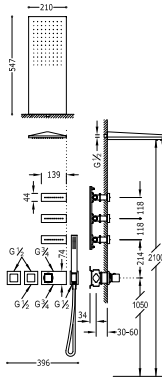

Kit doccia termostatica ad incasso BLOCK SYSTEM

- Con chiusura e regolazione di portata (3 vie).
- Corpo incassato termostatico incluso.
- Doccia acciaio inossidabile da parete 210x550 mm. (299.903.02).
- 3 jets anticalcare.
- Doccetta anticalcare (202.639.01).
- Flessibile satin (91.34.609.15).

IMPORTANTE: Montare uno scarico di >50 l/min.

Concealed thermostatic shower kit BLOCK SYSTEM

- with water shut off and flow control (3 ways).
- Built-in thermostatic body included.
- Stainless steel wall shower 210x550 mm. (299.903.02).
- 3 antilime jets.
- Antilime hand shower (202.639.01).
- Shower hose SATIN (91.34.609.15).

IMPORTANT: Assemble a drain of >50 l/min.

Termostatický podomítkový sprchový set BLOCK SYSTEM s uzávěrem a regulací průtoku (3-cestná).

- Včetně podomítkového termostatického tělesa.
- Nástěnné sprchové křepitko z nerez. oceli 210x550 mm (299.903.02).
- 3 natačecí trysky, proti usaz. vod. kamene.
- Ruční sprcha, proti usaz. vod. kamene (202.639.01).
- Flexi hadice SATIN (91.34.609.15).

DŮLEŽITÉ: Použijte odtokovou trubici pro průtok >50 l/min.



299.250.45

Cr | 207.253.01

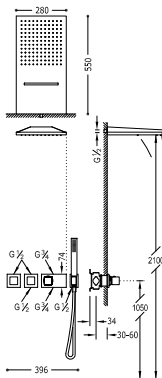

Kit doccia termostatica ad incasso BLOCK SYSTEM

- Con chiusura e regolazione di portata (3 vie).
- Corpo incassato termostatico incluso.
- Doccia acciaio inossidabile da parete con cascata 280x550 mm. 2 funzioni (299.903.01).
- Doccetta anticalcare (202.639.01).
- Flessibile satin (91.34.609.15).

IMPORTANTE: Montare uno scarico di >50 l/min.

Concealed thermostatic shower kit BLOCK SYSTEM

- with water shut off and flow control (3 ways).
- Built-in thermostatic body included.
- Stainless steel wall shower with cascade 280x550 mm. 2 positions (299.903.01).
- Antilime hand shower (202.639.01).
- Shower hose SATIN (91.34.609.15).

IMPORTANT: Assemble a drain of >50 l/min.

Termostatický podomítkový sprchový set BLOCK SYSTEM s uzávěrem a regulací průtoku (3-cestná).

- Včetně podomítkového termostatického tělesa.
- Nástěnné sprchové křepitko z nerez. oceli s kaskádou 280x550 mm., 2 funkce (299.903.01).
- Ruční sprcha, proti usaz. vod. kamene (202.639.01).
- Flexi hadice SATIN (91.34.609.15).

DŮLEŽITÉ: Použijte odtokovou trubici pro průtok >50 l/min.



299.250.45

Cr | 207.253.02

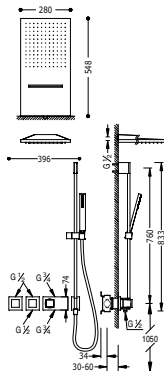
**Kit doccia termostatica ad incasso BLOCK SYSTEM**

Con chiusura e regolazione di portata (3 vie).

- Corpo incassato termostatico incluso.

- Doccia acciaio inossidabile da parete con cascata 280x550 mm.

2 funzioni (299.903.01).

- Barra di scorrimento con presa d'acqua a parete. Lung. 760 mm

- Doccetta anticalcare (202.639.01).

- Flessibile satin (91.34.609.15).

IMPORTANTE: Montare uno scarico di >50 l/min.

Concealed thermostatic shower kit BLOCK SYSTEM

with water shut off and flow control (3 ways).

- Built-in thermostatic body included.

- Stainless steel wall shower with cascade 280x550 mm.

2 positions (299.903.01).

- Sliding bar with wall water intake. Length: 760 mm.

- Antilime hand shower (202.639.01).

- Shower hose SATIN (91.34.609.15).

IMPORTANT: Assemble a drain of >50 l/min.

Termostatický podomítkový sprchový set BLOCK SYSTEM

s uzávěrem a regulací průtoku (3-cestná).

- Včetně podomítkového termostatického tělesa.

- Nástěnné sprchové kropítko z nerez. oceli s kaskádou

280x550 mm, 2 funkce (299.903.01).

- Posuvná tyč s nástěnným přívodem vody. Délka 760 mm.

- Ruční sprcha, proti usaz. vod. kamene (202.639.01).

- Flexi hadice SATIN (91.34.609.15).

DŮLEŽITÉ: Použijte odtokovou trubici pro průtok >50 l/min.



299.250.45

Cr | 207.253.09

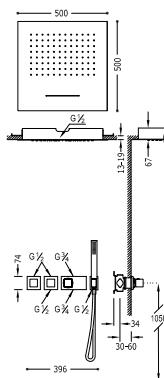
**Kit doccia termostatica ad incasso BLOCK SYSTEM**

Con chiusura e regolazione di portata (3 vie).

- Corpo incassato termostatico incluso.

- Soffione doccia acciaio inossidabile con cascata 500x500 mm.

2 funzioni (299.955.01).

- Doccetta anticalcare (202.639.01).

- Flessibile satin (91.34.609.15).

IMPORTANTE: Montare uno scarico di >50 l/min.

Concealed thermostatic shower kit BLOCK SYSTEM

with water shut off and flow control (3 ways).

- Built-in thermostatic body included.

- Stainless steel shower with cascade 500x500 mm. 2 positions

(299.955.01).

- Antilime hand shower (202.639.01).

- Shower hose SATIN (91.34.609.15).

IMPORTANT: Assemble a drain of >50 l/min.

Termostatický podomítkový sprchový set BLOCK SYSTEM

s uzávěrem a regulací průtoku (3-cestná).

- Včetně podomítkového termostatického tělesa.

- Sprcha z nerez. oceli s kaskádou 500x500 mm, 2 funkce

(299.955.01).

- Ruční sprcha, proti usaz. vod. kamene (202.639.01).

- Flexi hadice SATIN (91.34.609.15).

DŮLEŽITÉ: Použijte odtokovou trubici pro průtok >50 l/min.



299.250.45

Cr | 207.253.03

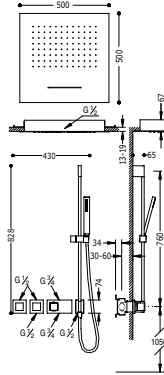

Kit doccia termostatica ad incasso BLOCK SYSTEM

- Con chiusura e regolazione di portata (3 vie).
- Corpo incassato termostatico incluso.
- Soffione doccia acciaio inossidabile con cascata 500x500 mm. 2 funzioni (299.955.01).
- Barra di scorrimento con presa d'acqua a parete. Lung. 760 mm.
- Doccetta anticalcare (202.639.01).
- Flessibile satin (91.34.609.15).
- IMPORTANTE: Montare uno scarico di >50 l/min.

Concealed thermostatic shower kit BLOCK SYSTEM

- with water shut off and flow control (3 ways).
- Built-in thermostatic body included.
- Stainless steel shower with cascade 500x500 mm. 2 positions (299.955.01).
- Sliding bar with wall water intake. Length: 760 mm.
- Antilime hand shower (202.639.01).
- Shower hose SATIN (91.34.609.15).
- IMPORTANT: Assemble a drain of >50 l/min.

Termostatický podomítkový sprchový set BLOCK SYSTEM

- s uzávěrem a regulací průtoku (3-cestná).
- Včetně podomítkového termostatického tělesa.
- Sprcha z nerez. oceli s kaskádou 500x500 mm, 2 funkce (299.955.01).
- Posuvná tyč s nástěnným přívodem vody. Délka 760 mm.
- Ruční sprcha, proti usaz. vod. kamene (202.639.01).
- Flexi hadice SATIN (91.34.609.15).
- DŮLEŽITÉ: Použijte odtokovou trubici pro průtok >50 l/min.



299.250.45

Cr | 207.253.11

**INSTALLAZIONE CONSIGLIATA
INSTALLATION RECOMMENDED
DOPORUČENÁ INSTALACE**

REF. 207.253.11

Questo è uno schema dell'installazione consigliata per ottimizzare le funzioni del rubinetto.

This is the installation scheme recommended to optimize the tap functions to the full.

Zde je doporučené schéma pro instalaci, pro zajištění maximálního využití funkcí baterie.

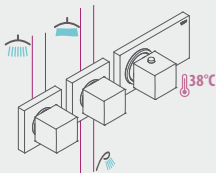

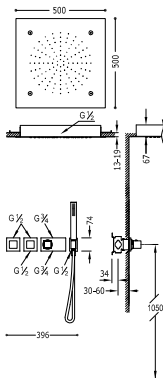

Kit doccia termostatica ad incasso BLOCK SYSTEM

- Con chiusura e regolazione di portata (3 vie).
- Corpo incassato termostatico incluso.
- Soffione doccia acciaio inossidabile con micro drop 500x500 mm. 2 funzioni (299.954.01).
- Doccetta anticalcare (202.639.01).
- Flessibile satin (91.34.609.15).

IMPORTANTE: Montare uno scarico di >50 l/min.

Concealed thermostatic shower kit BLOCK SYSTEM with water shut off and flow control (3 ways).

- Built-in thermostatic body included.
- Stainless steel shower with micro drop 500x500 mm. 2 positions (299.954.01).
- Antilime hand shower (202.639.01).
- Shower hose SATIN (91.34.609.15).

IMPORTANT: Assemble a drain of >50 l/min.

Termostatický podomítkový sprchový set BLOCK SYSTEM s uzávěrem a regulací průtoku (3-cestná).

- Včetně podomítkového termostatického tělesa.
- Sprcha z nerez. oceli s micro drop 500x500 mm, 2 funkce (299.954.01).
- Ruční sprcha, proti usaz. vod. kamene (202.639.01).
- Flexi hadice SATIN (91.34.609.15).

DŮLEŽITÉ: Použijte odtokovou trubici pro průtok >50 l/min.



299.250.45

Cr 207.253.12

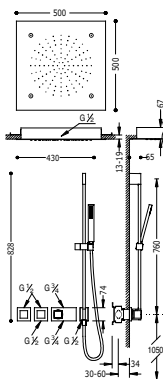

Kit doccia termostatica ad incasso BLOCK SYSTEM

- Con chiusura e regolazione di portata (3 vie).
- Corpo incassato termostatico incluso.
- Soffione doccia acciaio inossidabile con micro drop 500x500 mm. 2 funzioni (299.954.01).
- Barra di scorrimento con presa d'acqua a parete. Lung. 760 mm
- Doccetta anticalcare (202.639.01).
- Flessibile satin (91.34.609.15).

IMPORTANTE: Montare uno scarico di >50 l/min.

Concealed thermostatic shower kit BLOCK SYSTEM with water shut off and flow control (3 ways).

- Built-in thermostatic body included.
- Stainless steel shower with micro drop 500x500 mm. 2 positions (299.954.01).
- Sliding bar with wall water intake. Length: 760 mm.
- Antilime hand shower (202.639.01).
- Shower hose SATIN (91.34.609.15).

IMPORTANT: Assemble a drain of >50 l/min.

Termostatický podomítkový sprchový set BLOCK SYSTEM s uzávěrem a regulací průtoku (3-cestná).

- Včetně podomítkového termostatického tělesa.
- Sprcha z nerez. oceli s micro drop 500x500 mm, 2 funkce (299.954.01).
- Posuvná tyč s nástěnným přívodem vody. Délka 760 mm.
- Ruční sprcha, proti usaz. vod. kamene (202.639.01).
- Flexi hadice SATIN (91.34.609.15).

DŮLEŽITÉ: Použijte odtokovou trubici pro průtok >50 l/min.



299.250.45

Cr 207.253.13



Kit doccia termostatica ad incasso BLOCK SYSTEM CHROMOTHERAPY

- Con chiusura e regolazione di portata (3 vie).
- Corpo incassato termostatico incluso.
- Soffione doccia acciaio inossidabile 500x500 mm. (299.962.01).
- 3 jets anticalcare.
- Doccetta anticalcare (202.639.01).
- Flessibile satin (91.34.609.15).

IMPORTANTE: Montare uno scarico di >50 l/min.

Concealed thermostatic shower kit BLOCK SYSTEM CHROMOTHERAPY

- with water shut off and flow control (3 ways).
- Built-in thermostatic body included.
- Stainless steel ceiling shower 500x500 mm. (299.962.01).
- 3 antilime jets.
- Antilime hand shower (202.639.01).
- Shower hose SATIN (91.34.609.15).

IMPORTANT: Assemble a drain of >50 l/min.

Termostatický podomítkový sprchový set BLOCK SYSTEM CHROMOTHERAPY

- s uzávěrem a regulací průtoku (3-cestná).
- Včetně podomítkového termostatického tělesa.
- Sprchové kroupitko z nerez. oceli 500x500 mm. (299.962.01).
- 3 natáčecí trysky, proti usaz. vod. kamene.
- Ruční sprcha, proti usaz. vod. kamene (202.639.01).
- Flexi hadice SATIN (91.34.609.15).

DŮLEŽITÉ: Použijte odtokovou trubici pro průtok >50 l/min.

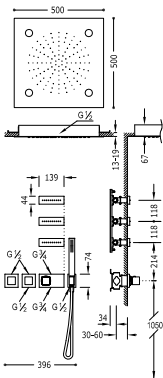

299.250.45

Cr | 207.253.04



Kit doccia termostatica ad incasso BLOCK SYSTEM

- Con chiusura e regolazione di portata (4 vie).
- Corpo incassato termostatico incluso.
- Soffione doccia acciaio inossidabile con cascata 500x500 mm.
- 2 funzioni (299.955.01).
- 3 jets anticalcare.
- Doccetta anticalcare (202.639.01).
- Flessibile satin (91.34.609.15).

IMPORTANTE: Montare uno scarico di >50 l/min.

Concealed thermostatic shower kit BLOCK SYSTEM

- with water shut off and flow control (4 ways).
- Built-in thermostatic body included.
- Stainless steel shower with cascade 500x500 mm. 2 positions (299.955.01).
- 3 antilime jets.
- Antilime hand shower (202.639.01).
- Shower hose SATIN (91.34.609.15).

IMPORTANT: Assemble a drain of >50 l/min.

Termostatický podomítkový sprchový set BLOCK SYSTEM

- s uzávěrem a regulací průtoku (4-cestná).
- Včetně podomítkového termostatického tělesa.
- Sprcha z nerez. oceli s kaskádou 500x500 mm, 2 funkce (299.955.01).
- 3 natáčecí trysky, proti usaz. vod. kamene.
- Ruční sprcha, proti usaz. vod. kamene (202.639.01).
- Flexi hadice SATIN (91.34.609.15).

DŮLEŽITÉ: Použijte odtokovou trubici pro průtok >50 l/min.

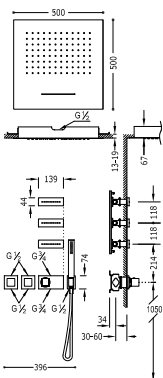

299.250.45

Cr | 207.254.02

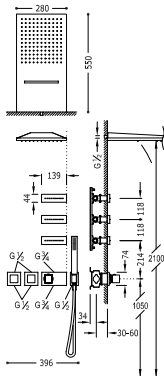

Kit doccia termostatica ad incasso BLOCK SYSTEM

- Con chiusura e regolazione di portata (4 vie).
- Corpo incassato termostatico incluso.
- Doccia acciaio inossidabile da parete con cascata 280x550 mm.
- 2 funzioni (299.903.01).
- 3 jets anticalcare.
- Doccetta anticalcare (202.639.01).
- Flessibile satin (91.34.609.15).
- IMPORTANTE: Montare uno scarico di >50 l/min.

Concealed thermostatic shower kit BLOCK SYSTEM

- with water shut off and flow control (3 ways).
- Built-in thermostatic body included.
- Stainless steel wall shower with cascade 280x550 mm.
- 2 positions (299.903.01).
- 3 antilime jets.
- Antilime hand shower (202.639.01).
- Shower hose SATIN (91.34.609.15).
- IMPORTANT: Assemble a drain of >50 l/min.

Termostatický podomítkový sprchový set BLOCK SYSTEM

- s uzávěrem a regulací průtoku (4-cestná).
- Včetně podomítkového termostatického tělesa.
- Nástěnné sprchové křepitko z nerez. oceli s kaskádou 280x550 mm., 2 funkce (299.903.01).
- 3 natáčecí trysky, proti usaz. vod. kamene.
- Ruční sprcha, proti usaz. vod. kamene (202.639.01).
- Flexi hadice SATIN (91.34.609.15).
- DŮLEŽITÉ: Použijte odtokovou trubici pro průtok >50 l/min.



Cr 207.254.01

INSTALLAZIONE CONSIGLIATA INSTALLATION RECOMMENDED DOPORUČENÁ INSTALACE

REF. 207.254.01

Questo è uno schema dell'installazione consigliata per ottimizzare le funzioni del rubinetto.

This is the installation scheme recommended to enjoy the tap functions to the full.

Zde je doporučené schéma pro instalaci, pro zajištění maximálního využití funkcí baterie.

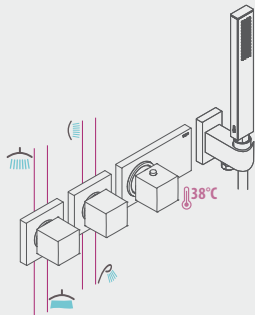

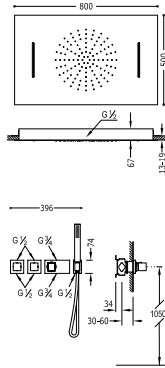

Kit doccia termostatica ad incasso BLOCK SYSTEM

Con chiusura e regolazione di portata (4 vie).

- Corpo incassato termostatico incluso.
- Soffione doccia acciaio inossidabile con cascata 500x800 mm, 2 funzioni (299.966.01).
- Doccetta anticalcare (202.639.01).
- Flessibile satin (91.34.609.15).

IMPORTANTE: Montare uno scarico di >50 l/min.

Concealed thermostatic shower kit BLOCK SYSTEM

with water shut off and flow control (4 ways).

- Built-in thermostatic body included.
- Stainless steel shower with cascade 500x800 mm, 2 positions (299.966.01).
- Antilime hand shower (202.639.01).
- Shower hose SATIN (91.34.609.15).

IMPORTANT: Assemble a drain of >50 l/min.

Termostatický podomítkový sprchový set BLOCK SYSTEM

s uzávěrem a regulací průtoku (4-cestná).

- Včetně podomítkového termostatického tělesa.
- Sprcha z nerez. oceli s kaskádou 500x800 mm, 2 funkce (299.966.01).
- Ruční sprcha, proti usaz. vod. kamene (202.639.01).
- Flexi hadice SATIN (91.34.609.15).

DŮLEŽITÉ: Použijte odtokovou trubici pro průtok >50 l/min.

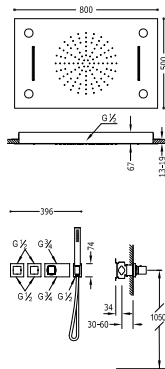

Kit doccia termostatica ad incasso BLOCK SYSTEM CHROMOTHERAPY

Con chiusura e regolazione di portata (4 vie).

- Corpo incassato termostatico incluso.
- Soffione doccia acciaio inossidabile con cascata 500x800 mm, 3 funzioni (299.965.01).
- Doccetta anticalcare (202.639.01).
- Flessibile satin (91.34.609.15).

IMPORTANTE: Montare uno scarico di >50 l/min.

Concealed thermostatic shower kit BLOCK SYSTEM CHROMOTHERAPY

with water shut off and flow control (4 ways).

- Built-in thermostatic body included.
- Stainless steel shower with cascade 500x800 mm, 3 positions (299.965.01).
- Antilime hand shower (202.639.01).
- Shower hose SATIN (91.34.609.15).

IMPORTANT: Assemble a drain of >50 l/min.

Termostatický podomítkový sprchový set BLOCK SYSTEM CHROMOTHERAPY

s uzávěrem a regulací průtoku (4-cestná).

- Včetně podomítkového termostatického tělesa.
- Sprcha z nerez. oceli s kaskádou 500x800 mm, 3 funkce (299.965.01).
- Ruční sprcha, proti usaz. vod. kamene (202.639.01).
- Flexi hadice SATIN (91.34.609.15).

DŮLEŽITÉ: Použijte odtokovou trubici pro průtok >50 l/min.



299.250.45

Cr | 207.250.03



299.250.45

Cr | 207.250.04



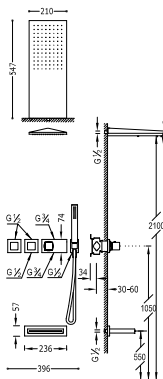

Kit termostatico vasca ad incasso BLOCK SYSTEM

- Con chiusura e regolazione di portata (3 vie).
- Corpo incassato termostatico incluso.
- Doccia acciaio inossidabile da parete 210x550 mm.
- Tubo cascata vasca acciaio inossidabile.
- Doccetta anticalcare.
- Flexibile satin.

IMPORTANTE: Montare uno scarico di >50 l/min.

Concealed thermostatic bath kit BLOCK SYSTEM

with water shut off and flow control (3 ways).

- Built-in thermostatic body included.
- Stainless steel wall shower 210x550 mm.
- Steel cascade cast spout.
- Antilime hand shower.
- Shower hose SATIN.

IMPORTANT: Assemble a drain of >50 l/min.

Termostatický podomítkový vanový set BLOCK SYSTEM

s uzávěrem a regulací průtoku (3-cestná).

- Včetně podomítkového termostatického tělesa.
- Nástěnné sprchové křepitko z nerez. oceli 210x550 mm.
- Vanové ramínko s kaskádou z nerez. oceli.
- Ruční sprcha, proti usaz. vod. kamene.
- Flexi hadice SATIN.

DŮLEŽITÉ: Použijte odtokovou trubici pro průtok >50 l/min.

Cr 299.250.45
Ac 299.250.45.AC

Cr 207.253.05
Ac 207.253.05.AC

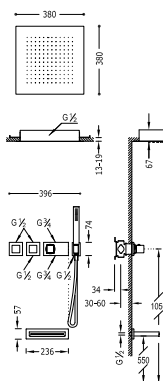

Kit termostatico vasca ad incasso BLOCK SYSTEM

Con chiusura e regolazione di portata (3 vie).

- Corpo incassato termostatico incluso.
- Soffione doccia acciaio inossidabile 380x380 mm. (1.34.944).
- Tubo cascata vasca acciaio inossidabile (299.903.04).
- Doccetta anticalcare (202.639.01).
- Flexibile satin (91.34.609.15).

IMPORTANTE: Montare uno scarico di >50 l/min.

Concealed thermostatic bath kit BLOCK SYSTEM

with water shut off and flow control (3 ways).

- Built-in thermostatic body included.
- Stainless steel ceiling shower 380x380 mm. (1.34.944).
- Steel cascade cast spout (299.903.04).
- Antilime hand shower (202.639.01).
- Shower hose SATIN (91.34.609.15).

IMPORTANT: Assemble a drain of >50 l/min.

Termostatický podomítkový vanový set BLOCK SYSTEM

s uzávěrem a regulací průtoku (3-cestná).

- Včetně podomítkového termostatického tělesa.
- Sprchové křepitko z nerez. oceli 380x380 mm. (1.34.944).
- Vanové ramínko s kaskádou z nerez. oceli (299.903.04).
- Ruční sprcha, proti usaz. vod. kamene (202.639.01).
- Flexi hadice SATIN (91.34.609.15).

DŮLEŽITÉ: Použijte odtokovou trubici pro průtok >50 l/min.

299.250.45

Cr 207.253.06





Kit termostatico vasca ad incasso BLOCK SYSTEM CHROMOTHERAPY

Con chiusura e regolazione di portata (3 vie).

- Corpo incassato termostatico incluso.
- Soffione doccia anticalcare 500x500 mm. (299.962.01).
- Tubo cascata vasca acciaio inossidabile (299.903.04).
- Doccetta anticalcare (202.639.01).
- Flessibile satin (91.34.609.15).

IMPORTANTE: Montare uno scarico di >50 l/min.

Concealed thermostatic bath kit BLOCK SYSTEM CHROMOTHERAPY

with water shut off and flow control (3 ways).

- Built-in thermostatic body included.
- Ceiling shower antilime 500x500 mm. (299.962.01).
- Steel cascade cast spout (299.903.04).
- Antilime hand shower (202.639.01).
- Shower hose SATIN (91.34.609.15).

IMPORTANT: Assemble a drain of >50 l/min.

Termostatický podomítkový vanový set BLOCK SYSTEM CHROMOTHERAPY

s uzávěrem a regulací průtoku (3-cestná).

- Včetně podomítkového termostatického tělesa.
- Stropní sprchové křížtiko z nerez. oceli 500x500 mm. (299.962.01).
- Vanové ramínko s kaskádou z nerez. oceli (299.903.04).
- Ruční sprcha, proti usaz. vod. kamene (202.639.01).
- Flexi hadice SATIN (91.34.609.15).

DŮLEŽITÉ: Použijte odtokovou trubici pro průtok >50 l/min.

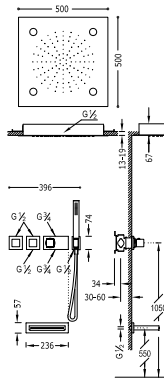

299.250.45

Cr | **207.253.07**

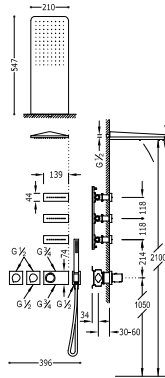

Kit doccia termostatica ad incasso BLOCK SYSTEM

- Con chiusura e regolazione di portata (3 vie).
 - Corpo incassato termostatico incluso.
 - Doccia acciaio inossidabile da parete 210x550 mm. (299.903.07).
 - 3 jets anticalcare.
 - Doccetta anticalcare (034.116.01).
 - Flessibile satin (91.34.609.15).
- IMPORTANTE: Montare uno scarico di >50 l/min.

Concealed thermostatic shower kit BLOCK SYSTEM with water shut off and flow control (3 ways).

- Built-in thermostatic body included.
 - Stainless steel wall shower 210x550 mm. (299.903.07).
 - 3 antilime jets.
 - Antilime hand shower (034.116.01).
 - Shower hose SATIN (91.34.609.15).
- IMPORTANT: Assemble a drain of >50 l/min.

Termostatický podomítkový sprchový set BLOCK SYSTEM s uzávěrem a regulací průtoku (3-cestná).

- Včetně podomítkového termostatického tělesa.
 - Nástěnné sprchové křepitko z nerez. oceli 210x550 mm. (299.903.07).
 - 3 natáčecí trysky, proti usaz. vod. kamene.
 - Ruční sprcha, proti usaz. vod. kamene (034.116.01).
 - Flexi hadice SATIN (91.34.609.15).
- DŮLEŽITÉ: Použijte odtokovou trubici pro průtok >50 l/min.



Cr 207.353.01

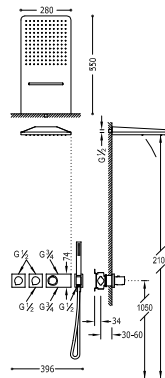

Kit doccia termostatica ad incasso BLOCK SYSTEM

- Con chiusura e regolazione di portata (3 vie).
 - Corpo incassato termostatico incluso.
 - Doccia acciaio inossidabile da parete con cascata 280x550 mm.
 - 2 funzioni (299.903.08).
 - Doccetta anticalcare (034.116.01).
 - Flessibile satin (91.34.609.15).
- IMPORTANTE: Montare uno scarico di >50 l/min.

Concealed thermostatic shower kit BLOCK SYSTEM with water shut off and flow control (3 ways).

- Built-in thermostatic body included.
 - Stainless steel wall shower with cascade 280x550 mm.
 - 2 positions (299.903.08).
 - Antilime hand shower (034.116.01).
 - Shower hose SATIN (91.34.609.15).
- IMPORTANT: Assemble a drain of >50 l/min.

Termostatický podomítkový sprchový set BLOCK SYSTEM s uzávěrem a regulací průtoku (3-cestná).

- Včetně podomítkového termostatického tělesa.
 - Nástěnné sprchové křepitko z nerez. oceli s kaskádou 280x550 mm. 2 funkce (299.903.08).
 - Ruční sprcha, proti usaz. vod. kamene (034.116.01).
 - Flexi hadice SATIN (91.34.609.15).
- DŮLEŽITÉ: Použijte odtokovou trubici pro průtok >50 l/min.



Cr 207.353.02

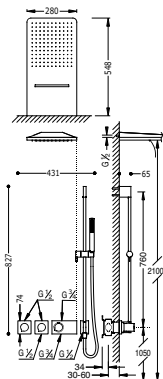

Kit doccia termostatica ad incasso BLOCK SYSTEM

- Con chiusura e regolazione di portata (3 vie).
- Corpo incassato termostatico incluso.
- Doccia acciaio inossidabile da parete con cascata 280x550 mm.
- 2 funzioni (299.903.08).
- Barra di scorrimento con presa d'acqua a parete. Lung. 760 mm
- Doccetta anticalcare (034.116.01).
- Flessibile satin (91.34.609.15).
- IMPORTANTE: Montare uno scarico di >50 l/min.

Concealed thermostatic shower kit BLOCK SYSTEM

- with water shut off and flow control (3 ways).
- Built-in thermostatic body included.
- Stainless steel wall shower with cascade 280x550 mm.
- 2 positions (299.903.08).
- Sliding bar with wall water intake. Length: 760 mm.
- Antilime hand shower (034.116.01).
- Shower hose SATIN (91.34.609.15).
- IMPORTANT: Assemble a drain of >50 l/min.

Termostatický podomítkový sprchový set BLOCK SYSTEM

- s uzávěrem a regulací průtoku (3-cestná).
- Včetně podomítkového termostatického tělesa.
- Nástěnné sprchové křepitko z nerez. oceli s kaskádou 280x550 mm. 2 funkce (299.903.08).
- Posuvná tyč s nástěnným příívodem vody. Délka 760 mm.
- Ruční sprcha, proti usaz. vod. kamene (034.116.01).
- Flexi hadice SATIN (91.34.609.15).
- DŮLEŽITÉ: Použijte odtokovou trubici pro průtok >50 l/min.

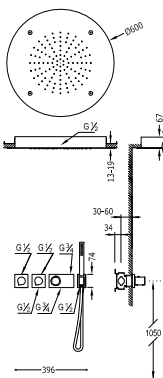

Kit doccia termostatica ad incasso BLOCK SYSTEM

- Con chiusura e regolazione di portata (3 vie).
- Corpo incassato termostatico incluso.
- Soffione doccia acciaio inossidabile con micro drop Ø 600 mm.
- 2 funzioni (299.956.01).
- Doccetta anticalcare (034.116.01).
- Flessibile satin (91.34.609.15).
- IMPORTANTE: Montare uno scarico di >50 l/min.

Concealed thermostatic shower kit BLOCK SYSTEM

- with water shut off and flow control (3 ways).
- Built-in thermostatic body included.
- Stainless steel shower with micro drop Ø 600 mm. 2 positions (299.956.01).
- Antilime hand shower (034.116.01).
- Shower hose SATIN (91.34.609.15).
- IMPORTANT: Assemble a drain of >50 l/min.

Termostatický podomítkový sprchový set BLOCK SYSTEM

- s uzávěrem a regulací průtoku (3-cestná).
- Včetně podomítkového termostatického tělesa.
- Sprcha z nerez. oceli s micro drop Ø 600 mm. 2 funkce (299.956.01).
- Ruční sprcha, proti usaz. vod. kamene (034.116.01).
- Flexi hadice SATIN (91.34.609.15).
- DŮLEŽITÉ: Použijte odtokovou trubici pro průtok >50 l/min.



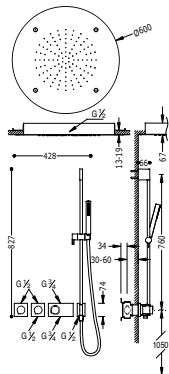

Kit doccia termostatica ad incasso BLOCK SYSTEM

- Con chiusura e regolazione di portata (3 vie).
- Corpo incassato termostatico incluso.
- Soffione doccia acciaio inossidabile con micro drop Ø 600 mm.
- 2 funzioni (299.956.01).
- Barra di scorrimento con presa d'acqua a parete. Lung. 760 mm
- Doccetta anticalcare (034.116.01).
- Flessibile satin (91.34.609.15).

IMPORTANTE: Montare uno scarico di >50 l/min.

Concealed thermostatic shower kit BLOCK SYSTEM

- with water shut off and flow control (3 ways).
- Built-in thermostatic body included.
- Stainless steel shower with micro drop Ø 600 mm. 2 positions (299.956.01).
- Sliding bar with wall water intake. Length: 760 mm.
- Antilime hand shower (034.116.01).
- Shower hose SATIN (91.34.609.15).

IMPORTANT: Assemble a drain of >50 l/min.

Termostatický podomítkový sprchový set BLOCK SYSTEM

- s uzávěrem a regulací průtoku (3-cestná).
- Včetně podomítkového termostatického tělesa.
- Sprcha z nerez. oceli s micro drop Ø 600 mm. 2 funkce (299.956.01).
- Posuvná tyč s nástěnným přívodem vody. Délka 760 mm.
- Ruční sprcha, proti usaz. vod. kamene (034.116.01).
- Flexi hadice SATIN (91.34.609.15).

DŮLEŽITÉ: Použijte odtokovou trubici pro průtok >50 l/min.



Cr 207.353.11

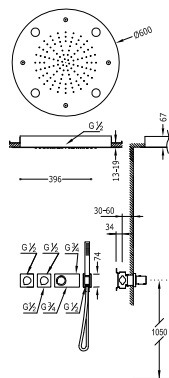

Kit doccia termostatica ad incasso BLOCK SYSTEM

- CHROMOTHERAPY
- Con chiusura e regolazione di portata (3 vie).
- Corpo incassato termostatico incluso.
- Soffione doccia acciaio inossidabile con micro drop Ø 600 mm.
- 3 funzioni (299.958.01).
- Doccetta anticalcare (034.116.01).
- Flessibile satin (91.34.609.15).

IMPORTANTE: Montare uno scarico di >50 l/min.

Concealed thermostatic shower kit BLOCK SYSTEM

- CHROMOTHERAPY
- with water shut off and flow control (3 ways).
- Built-in thermostatic body included.
- Stainless steel shower with micro drop Ø 600 mm. 3 positions (299.958.01).
- Antilime hand shower (034.116.01).
- Shower hose SATIN (91.34.609.15).

IMPORTANT: Assemble a drain of >50 l/min.

Termostatický podomítkový sprchový set BLOCK SYSTEM

- CHROMOTHERAPY
- s uzávěrem a regulací průtoku (3-cestná).
- Včetně podomítkového termostatického tělesa.
- Sprcha z nerez. oceli s micro drop Ø 600 mm. 3 funkce (299.958.01).
- Ruční sprcha, proti usaz. vod. kamene (034.116.01).
- Flexi hadice SATIN (91.34.609.15).

DŮLEŽITÉ: Použijte odtokovou trubici pro průtok >50 l/min.



Cr 207.353.12



Kit doccia termostatica ad incasso BLOCK SYSTEM

- Con chiusura e regolazione di portata (3 vie).
- Corpo incassato termostatico incluso.
- Soffione doccia acciaio inossidabile con cascata 500x500 mm.
- 2 funzioni (299.955.01).
- Doccetta anticalcare (034.116.01).
- Flessibile satin (91.34.609.15).

IMPORTANTE: Montare uno scarico di >50 l/min.

Concealed thermostatic shower kit BLOCK SYSTEM

- with water shut off and flow control (3 ways).
- Built-in thermostatic body included.
- Stainless steel shower with cascade 500x500 mm. 2 positions (299.955.01).
- Antilime hand shower (034.116.01).
- Shower hose SATIN (91.34.609.15).

IMPORTANT: Assemble a drain of >50 l/min.

Termostatický podomítkový sprchový set BLOCK SYSTEM

- s uzávěrem a regulací průtoku (3-cestná).
- Včetně podomítkového termostatického tělesa.
- Sprcha z nerez. oceli s kaskádou 500x500 mm. 2 funkce (299.955.01).
- Ruční sprcha, proti usaz. vod. kamene (034.116.01).
- Flexi hadice SATIN (91.34.609.15).

DŮLEŽITÉ: Použijte odtokovou trubici pro průtok >50 l/min.

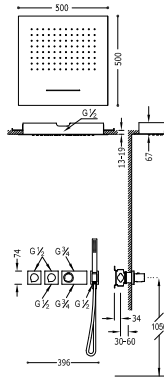

Kit doccia termostatica ad incasso BLOCK SYSTEM CHROMOTHERAPY

- Con chiusura e regolazione di portata (3 vie).
- Corpo incassato termostatico incluso.
- Soffione doccia acciaio inossidabile 500x500 mm. (299.962.01).
- 3 jets anticalcare.
- Doccetta anticalcare (034.116.01).
- Flessibile satin (91.34.609.15).

IMPORTANTE: Montare uno scarico di >50 l/min.

Concealed thermostatic shower kit BLOCK SYSTEM CHROMOTHERAPY

- with water shut off and flow control (3 ways).
- Built-in thermostatic body included.
- Stainless steel ceiling shower 500x500 mm. (299.962.01).
- 3 antilime jets.
- Antilime hand shower (034.116.01).
- Shower hose SATIN (91.34.609.15).

IMPORTANT: Assemble a drain of >50 l/min.

Termostatický podomítkový sprchový set BLOCK SYSTEM CHROMOTHERAPY

- s uzávěrem a regulací průtoku (3-cestná).
- Včetně podomítkového termostatického tělesa.
- Sprchové křepitko z nerez. oceli 500x500 mm. (299.962.01).
- 3 natače trysky, proti usaz. vod. kamene.
- Ruční sprcha, proti usaz. vod. kamene (034.116.01).
- Flexi hadice SATIN (91.34.609.15).

DŮLEŽITÉ: Použijte odtokovou trubici pro průtok >50 l/min.

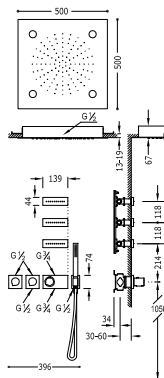

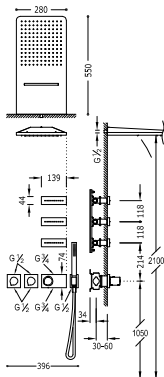
**Kit doccia termostatica ad incasso BLOCK SYSTEM**

- Con chiusura e regolazione di portata (4 vie).
- Corpo incassato termostatico incluso.
- Doccia acciaio inossidabile da parete con cascata 280x550 mm.
- 2 funzioni (299.903.08).
- 3 jets anticalcare.
- Doccetta anticalcare (202.639.01).
- Flessibile satin (91.34.609.15).

IMPORTANTE: Montare uno scarico di >50 l/min.

Concealed thermostatic shower kit BLOCK SYSTEM

- with water shut off and flow control (3 ways).
- Build-in thermostatic body included.
- Stainless steel wall shower with cascade 280x550 mm.
- 2 positions (299.903.08).
- 3 antilime jets.
- Antilime hand shower (034.116.01).
- Shower hose SATIN (91.34.609.15).

IMPORTANT: Assemble a drain of >50 l/min.

Termostatický podomítkový sprchový set BLOCK SYSTEM

- s uzávěrem a regulací průtoku (4-cestná).
- Včetně podomítkového termostatického tělesa.
- Nástěnné sprchové křepitko z nerez. oceli s kaskádou 280x550 mm. z funkce (299.903.08).
- 3 natižecí trysky, proti usaz. vod. kamene.
- Ruční sprcha, proti usaz. vod. kamene (034.116.01).
- Flexi hadice SATIN (91.34.609.15).

DŮLEŽITÉ: Použijte odtokovou trubici pro průtok >50 l/min.



299.195.03

Cr 207.354.01

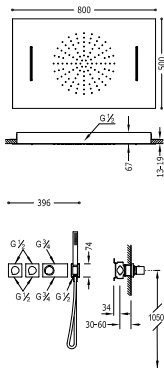
**Kit doccia termostatica ad incasso BLOCK SYSTEM**

- Con chiusura e regolazione di portata (4 vie).
- Corpo incassato termostatico incluso.
- Soffione doccia acciaio inossidabile con cascata 500x800 mm.
- 2 funzioni (299.966.01).
- Doccetta anticalcare (034.116.01).
- Flessibile satin (91.34.609.15).

IMPORTANTE: Montare uno scarico di >50 l/min.

Concealed thermostatic shower kit BLOCK SYSTEM

- with water shut off and flow control (4 ways).
- Build-in thermostatic body included.
- Stainless steel shower with cascade 500x800 mm. 2 positions (299.966.01).
- Antilime hand shower (034.116.01).
- Shower hose SATIN (91.34.609.15).

IMPORTANT: Assemble a drain of >50 l/min.

Termostatický podomítkový sprchový set BLOCK SYSTEM

- s uzávěrem a regulací průtoku (4-cestná).
- Včetně podomítkového termostatického tělesa.
- Sprcha z nerez. oceli s kaskádou 500x800 mm. z funkce (299.966.01).
- Ruční sprcha, proti usaz. vod. kamene (034.116.01).
- Flexi hadice SATIN (91.34.609.15).

DŮLEŽITÉ: Použijte odtokovou trubici pro průtok >50 l/min.



299.195.03

Cr 207.354.03



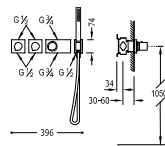
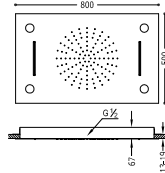

Kit doccia termostatica ad incasso BLOCK SYSTEM CHROMOTHERAPY

- Con chiusura e regolazione di portata (4 vie).
- Corpo incassato termostatico incluso.
- Soffione doccia acciaio inossidabile con cascata 500x800 mm.
- 3 funzioni (299.965.01).
- Doccetta anticalcare (034.116.01).
- Flessibile satin (91.34.609.15).

IMPORTANTE: Montare uno scarico di >50 l/min.

Concealed thermostatic shower kit BLOCK SYSTEM CHROMOTHERAPY

- with water shut off and flow control (4 ways).
- Built-in thermostatic body included.
- Stainless steel shower with cascade 500x800 mm. 3 positions (299.965.01).
- Anti-lime hand shower (034.116.01).
- Shower hose SATIN (91.34.609.15).

IMPORTANT: Assemble a drain of >50 l/min.

Termostatický podomítkový sprchový set BLOCK SYSTEM CHROMOTHERAPY

- s uzávěrem a regulací průtoku (4-cestná).
- Včetně podomítkového termostatického tělesa.
- Sprcha z nerez. oceli s kaskádou 500x800 mm. 3 funkce (299.965.01).
- Ruční sprcha, proti usaz. vod. kamene (034.116.01).
- Flexi hadice SATIN (91.34.609.15).

DŮLEŽITÉ: Použijte odtokovou trubici pro průtok >50 l/min.



299.195.03

Cr | 207.354.04

**INSTALLAZIONE CONSIGLIATA
INSTALLATION RECOMMENDED
DOPORUČENÁ INSTALACE**

REF. 207.354.04

Questo è uno schema dell'installazione consigliata per ottimizzare le funzioni del rubinetto.

This is the installation scheme recommended to optimize the tap functions to the full.

Zde je doporučené schéma pro instalaci, pro zajištění maximálního využití funkcí baterie.

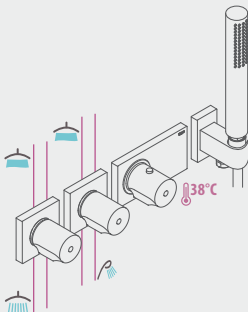

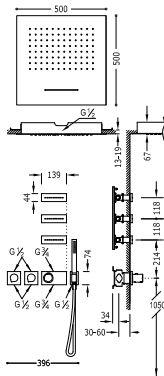

Kit doccia termostatica ad incasso BLOCK SYSTEM

- Con chiusura e regolazione di portata (4 vie).
- Corpo incassato termostatico incluso.
- Soffione doccia acciaio inossidabile con cascata 500x500 mm.
- 2 funzioni (299.955.01).
- 3 jets anticalcare.
- Doccetta anticalcare (202.639.01).
- Flessibile satin (91.34.609.15).

IMPORTANTE: Montare uno scarico di >50 l/min.

Concealed thermostatic shower kit BLOCK SYSTEM

- with water shut off and flow control (4 ways).
- Built-in thermostatic body included.
- Stainless steel shower with cascade 500x500 mm. 2 positions (299.955.01).
- 3 antilime jets.
- Antilime hand shower (034.116.01).
- Shower hose SATIN (91.34.609.15).

IMPORTANT: Assemble a drain of >50 l/min.

Termostatický podomítkový sprchový set BLOCK SYSTEM

- s uzávěrem a regulací průtoku (4-cestná).
- Včetně podomítkového termostatického tělesa.
- Sprcha z nerez. oceli s kaskádou 500x500 mm. 2 funkce (299.955.01).
- 3 natáčecí trysky, proti usaz. vod. kamene.
- Ruční sprcha, proti usaz. vod. kamene (034.116.01).
- Flexi hadice SATIN (91.34.609.15).

DŮLEŽITÉ: Použijte odtokovou trubici pro průtok >50 l/min.

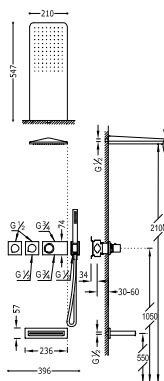

Kit termostatico vasca ad incasso BLOCK SYSTEM

- Con chiusura e regolazione di portata (3 vie).
- Corpo incassato termostatico incluso.
- Doccia acciaio inossidabile da parete 210x550 mm. (299.903.07).
- Tubo cascata vasca acciaio inossidabile (299.903.04).
- Doccetta anticalcare (034.116.01).
- Flessibile satin (91.34.609.15).

IMPORTANTE: Montare uno scarico di >50 l/min.

Concealed thermostatic bath kit BLOCK SYSTEM

- with water shut off and flow control (3 ways).
- Built-in thermostatic body included.
- Stainless steel wall shower 210x550 mm. (299.903.07).
- Stainless steel cascade cast spout (299.903.04).
- Antilime hand shower (034.116.01).
- Shower hose SATIN (91.34.609.15).

IMPORTANT: Assemble a drain of >50 l/min.

Termostatický podomítkový vanový set BLOCK SYSTEM

- s uzávěrem a regulací průtoku (3-cestná).
- Včetně podomítkového termostatického tělesa.
- Nástěnné sprchové křepitko z nerez. oceli 210x550 mm. (299.903.07).
- Vanové ramínko s kaskádou z nerez. oceli (299.903.04).
- Ruční sprcha, proti usaz. vod. kamene (034.116.01).
- Flexi hadice SATIN (91.34.609.15).

DŮLEŽITÉ: Použijte odtokovou trubici pro průtok >50 l/min.



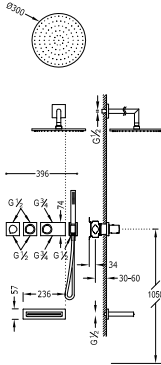

Kit termostatico vasca ad incasso BLOCK SYSTEM

- Con chiusura e regolazione di portata (3 vie).
- Corpo incassato termostatico incluso.
- Doccia fissa Ø 300 mm. con snodo. Ottone.
- Tubo cascata vasca acciaio inossidabile.
- Doccetta anticalcare.
- Flexibile satin (91.34.609.15).

IMPORTANTE: Montare uno scarico di >50 l/min.

Concealed thermostatic bath kit BLOCK SYSTEM

with water shut off and flow control (3 ways).

- Built-in thermostatic body included.
- Fixed shower head Ø 300 mm. with ball joint. Brass.
- Steel cascade cast spout.
- Antilime hand shower.
- Shower hose SATIN (91.34.609.15).

IMPORTANT: Assemble a drain of >50 l/min.

Termostatický podomítkový vanový set BLOCK SYSTEM

s uzávěrem a regulací průtoku (3-cestná).

- Včetně podomítkového termostatického tělesa.
- Pevná sprcha Ø 300 mm. s kloubem. Materiál Mosaz.
- Vanové ramínko s kaskádou z nerez. oceli.
- Ruční sprcha, proti usaz. vod. kamene.
- Flexi hadice SATIN (91.34.609.15).

DŮLEŽITÉ: Použijte odtokovou trubici pro průtok >50 l/min.

Cr 299.195.03
Ac 299.195.03.AC

Cr **207.353.08**
Ac **207.353.08.AC**

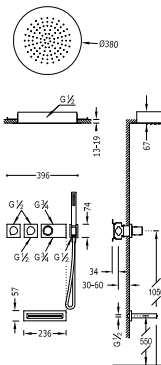

Kit termostatico vasca ad incasso BLOCK SYSTEM

Con chiusura e regolazione di portata (3 vie).

- Corpo incassato termostatico incluso.
- Soffione doccia acciaio inossidabile Ø 380 mm. (1.34.940).
- Tubo cascata vasca acciaio inossidabile (299.903.04).
- Doccetta anticalcare (034.116.01).
- Flexibile satin (91.34.609.15).

IMPORTANTE: Montare uno scarico di >50 l/min.

Concealed thermostatic bath kit BLOCK SYSTEM

with water shut off and flow control (3 ways).

- Built-in thermostatic body included.
- Stainless steel ceiling shower Ø 380 mm. (1.34.940).
- Steel cascade cast spout (299.903.04).
- Antilime hand shower (034.116.01).
- Shower hose SATIN (91.34.609.15).

IMPORTANT: Assemble a drain of >50 l/min.

Termostatický podomítkový vanový set BLOCK SYSTEM

s uzávěrem a regulací průtoku (3-cestná).

- Včetně podomítkového termostatického tělesa.
- Sprchové křepitko z nerez. oceli Ø 380 mm. (1.34.940).
- Vanové ramínko s kaskádou z nerez. oceli (299.903.04).
- Ruční sprcha, proti usaz. vod. kamene (034.116.01).
- Flexi hadice SATIN (91.34.609.15).

DŮLEŽITÉ: Použijte odtokovou trubici pro průtok >50 l/min.

299.195.03

Cr **207.353.06**



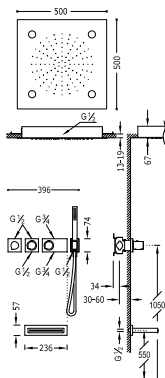

Kit termostatico vasca ad incasso BLOCK SYSTEM CHROMOTHERAPY

- Con chiusura e regolazione di portata (3 vie).
- Corpo incassato termostatico incluso.
- Soffione doccia anticalcare 500x500 mm. (299.962.01).
- Tubo cascata vasca acciaio inossidabile (299.903.04).
- Doccetta anticalcare (034.116.01).
- Flessibile satin (91.34.609.15).

IMPORTANTE: Montare uno scarico di >50 l/min.

Concealed thermostatic bath kit BLOCK SYSTEM CHROMOTHERAPY

- with water shut off and flow control (3 ways).
- Built-in thermostatic body included.
- Ceiling shower antilime 500x500 mm. (299.962.01).
- Steel cascade cast spout (299.903.04).
- Antilime hand shower (034.116.01).
- Shower hose SATIN (91.34.609.15).

IMPORTANT: Assemble a drain of >50 l/min.

Termostatický podomítkový vanový set BLOCK SYSTEM CHROMOTHERAPY

- s uzávěrem a regulací průtoku (3-cestná).
- Včetně podomítkového termostatického tělesa.
- Sprchové kropítko z nerez. oceli 500x500 mm. (299.962.01).
- Vanové ramínko s kaskádou z nerez. oceli (299.903.04).
- Ruční sprcha, proti usaz. vod. kamene (034.116.01).
- Flexi hadice SATIN (91.34.609.15).

DŮLEŽITÉ: Použijte odtokovou trubici pro průtok >50 l/min.



299.195.03

Cr 207.353.07

INSTALLAZIONE CONSIGLIATA INSTALLATION RECOMMENDED DOPORUČENÁ INSTALACE

REF. 207.353.07

Questo è uno schema dell'installazione consigliata per ottimizzare le funzioni del rubinetto.

This is the installation scheme recommended to enjoy the tap functions to the full.

Zde je doporučené schéma pro instalaci, pro zajištění maximálního využití funkcí baterie.

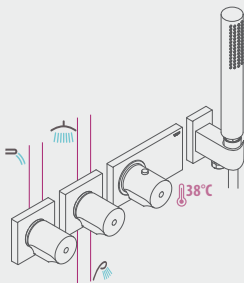



TRES
BLOCK
SYSTEM



Ref. / Nr. / Kód: |

N

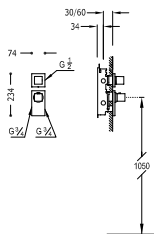

Termostatica ad incasso BLOCK SYSTEM

Con chiusura e regolazione di portata.

· Corpo incassato termostatico incluso.

* NOTA: è obbligatorio aggiungere all'ordine un soffione, doccia a mano, bocchette o una canna per vasca da bagno, a seconda del tipo di installazione.

Concealed thermostatic mixer BLOCK SYSTEM

with water shut off and flow control.

· Built-in thermostatic body included.

* NOTE: A spray nozzle, shower head, jet or bath spout must be added to the order, depending on installation type.

Termostatická podomítková baterie BLOCK SYSTEM

s uzávěrem a regulací průtoku.

· Včetně podomítkového termostatického tělesa.

* POZNÁMKA: Podle typu instalace je nutno přidat k objednávce křepítko, ruční sprchu, trysky nebo ramínko na vanu.



299.250.45

1 via/cestné/way

Cr 206.251.99



299.250.45

2 vie/cestná/ways

Cr *206.252.99

1-2 VIE / WAYS / CESTNÁ

N

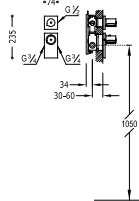

Termostatica ad incasso BLOCK SYSTEM

Con chiusura e regolazione di portata.

· Corpo incassato termostatico incluso.

* NOTA: è obbligatorio aggiungere all'ordine un soffione, doccia a mano, bocchette o una canna per vasca da bagno, a seconda del tipo di installazione.

Concealed thermostatic mixer BLOCK SYSTEM

with water shut off and flow control.

· Built-in thermostatic body included.

* NOTE: A spray nozzle, shower head, jet or bath spout must be added to the order, depending on installation type.

Termostatická podomítková baterie BLOCK SYSTEM

s uzávěrem a regulací průtoku.

· Včetně podomítkového termostatického tělesa.

* POZNÁMKA: Podle typu instalace je nutno přidat k objednávce křepítko, ruční sprchu, trysky nebo ramínko na vanu.



299.250.45

1 via/cestné/way

Cr 206.351.99



299.250.45

2 vie/cestná/ways

Cr *206.352.99

N

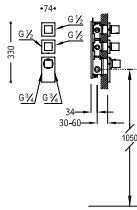

Termostatica ad incasso BLOCK SYSTEM

Con chiusura e regolazione di portata.

- Corpo incassato termostatico incluso.

* **NOTA:** è obbligatorio aggiungere all'ordine un soffione, doccia a mano, bocchette o una canna per vasca da bagno, a seconda del tipo di installazione.

Concealed thermostatic mixer BLOCK SYSTEM

with water shut off and flow control.

- Built-in thermostatic body included.

* **NOTE:** A spray nozzle, shower head, jet or bath spout must be added to the order, depending on installation type.

Termostatická podomítková baterie BLOCK SYSTEM

s uzávěrem a regulací průtoku.

- Včetně podomítkového termostatického tělesa.

* **POZNÁMKA:** Podle typu instalace je nutno přidat k objednávce kropítko, ruční sprchu, trysky nebo ramínko na vanu.



299.250.45

3 vie/cestná/ways

Cr | *206.253.99 |



299.250.45

4 vie/cestná/ways

Cr | *206.254.99 |

N

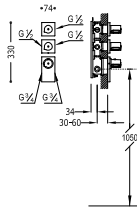

Termostatica ad incasso BLOCK SYSTEM

Con chiusura e regolazione di portata.

- Corpo incassato termostatico incluso.

* **NOTA:** è obbligatorio aggiungere all'ordine un soffione, doccia a mano, bocchette o una canna per vasca da bagno, a seconda del tipo di installazione.

Concealed thermostatic mixer BLOCK SYSTEM

with water shut off and flow control.

- Built-in thermostatic body included.

* **NOTE:** A spray nozzle, shower head, jet or bath spout must be added to the order, depending on installation type.

Termostatická podomítková baterie BLOCK SYSTEM

s uzávěrem a regulací průtoku.

- Včetně podomítkového termostatického tělesa.

* **POZNÁMKA:** Podle typu instalace je nutno přidat k objednávce kropítko, ruční sprchu, trysky nebo ramínko na vanu.



299.250.45

3 vie/cestná/ways

Cr | *206.353.99 |



299.250.45

4 vie/cestná/ways

Cr | *206.354.99 |

BLOCK SYSTEM



N

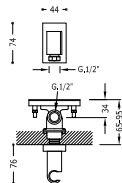

Supporto per doccia BLOCK SYSTEM

con presa d'acqua a parete con profondità regolabile e valvola antiritorno. Corpo incassato incluso.

Shower holder BLOCK SYSTEM

with adjustable depth wall water inlet fitting and anti-return valve. Built-in body included

Úchyt ruční sprchy se stěnovou přípojkou vody BLOCK SYSTEM

s nastavitelným výstupem pro vodu a zpětným ventilem. Včetně podomítkového tělesa.

Cr | 207.182.02 |

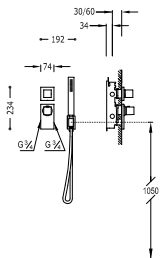

Termostatica ad incasso BLOCK SYSTEM

- Con chiusura e regolazione di portata.
- Corpo incassato termostatico incluso.
- Doccetta anticalcare (202.639.01).
- Flexibile satin (91.34.609.15).

* NOTE: è obbligatorio aggiungere all'ordine un soffione, bocchette o una canna per vasca da bagno, a seconda del tipo di installazione.

Concealed thermostatic mixer BLOCK SYSTEM

with water shut off and flow control.

- Built-in thermostatic body included.
- Antilime hand shower (202.639.01).
- Shower hose SATIN (91.34.609.15).

* NOTE: A shower head, jet or bath spout must be added to the order, depending on installation type.

Termostatická podomítková baterie BLOCK SYSTEM

s uzávěrem a regulací průtoku.

- Včetně podomítkového termostatického tělesa.
- Ruční sprcha, proti usaz. vod. kamene (202.639.01).
- Flexi hadice SATIN (91.34.609.15).

* POZNÁMKA: Podle typu instalace je nutno přidat k objednávce křepitko, trysky nebo ramínko na vanu.



299.250.45

1 via/cestné/way

Cr *206.251.91



299.250.45

2 vie/cestná/ways

Cr *206.252.91

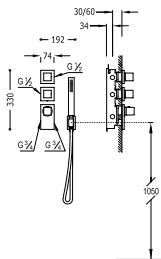

Termostatica ad incasso BLOCK SYSTEM

- Con chiusura e regolazione di portata.
- Corpo incassato termostatico incluso.
- Doccetta anticalcare (202.639.01).
- Flexibile satin (91.34.609.15).

* NOTE: è obbligatorio aggiungere all'ordine un soffione, bocchette o una canna per vasca da bagno, a seconda del tipo di installazione.

Concealed thermostatic mixer BLOCK SYSTEM

with water shut off and flow control.

- Built-in thermostatic body included.
- Antilime hand shower (202.639.01).
- Shower hose SATIN (91.34.609.15).

* NOTE: A shower head, jet or bath spout must be added to the order, depending on installation type.

Termostatická baterie podomítková BLOCK SYSTEM

s uzávěrem a regulací průtoku.

- Včetně podomítkového termostatického tělesa.
- Ruční sprcha, proti usaz. vod. kamene (202.639.01).
- Flexi hadice SATIN (91.34.609.15).

* POZNÁMKA: Podle typu instalace je nutno přidat k objednávce křepitko, trysky nebo ramínko na vanu.



299.250.45

3 vie/cestná/ways

Cr *206.253.91



299.250.45

4 vie/cestná/ways

Cr *206.254.91





Termostatica ad incasso BLOCK SYSTEM

- Con chiusura e regolazione di portata.
- Corpo incassato termostatico incluso
- Doccetta anticalcare (034.116.01).
- Flessibile satin (91.34.609.15).

* NOTA: è obbligatorio aggiungere all'ordine un soffione, bocchette o una canna per vasca da bagno, a seconda del tipo di installazione.

Concealed thermostatic mixer BLOCK SYSTEM

with water shut off and flow control.

- Built-in thermostatic body included
- Antilime hand shower (034.116.01).
- Shower hose SATIN (91.34.609.15).

* NOTE: A shower head, jet or bath spout must be added to the order, depending on installation type.

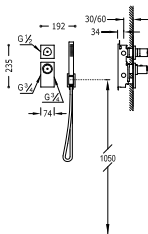

Termostatická baterie podomítková BLOCK SYSTEM

s uzávěrem a regulací průtoku.

- Včetně podomítkového termostatického tělesa
- Ruční sprcha, proti usaz. vod. kamene (034.116.01).
- Flexi hadice SATIN (91.34.609.15).

* POZNÁMKA: Podle typu instalace je nutno přidat k objednávce křepitko, trysky nebo ramínko na vanu.

299.195.03
1 via/cestná/way

Cr | *206.351.91 |

299.195.03
2 vie/cestná/ways

Cr | *206.352.91 |



Termostatica ad incasso BLOCK SYSTEM

- Con chiusura e regolazione di portata.
- Corpo incassato termostatico incluso
- Doccetta anticalcare (034.116.01).
- Flessibile satin (91.34.609.15).

* NOTA: è obbligatorio aggiungere all'ordine un soffione, bocchette o una canna per vasca da bagno, a seconda del tipo di installazione.

Concealed thermostatic mixer BLOCK SYSTEM

with water shut off and flow control.

- Built-in thermostatic body included
- Antilime hand shower (034.116.01).
- Shower hose SATIN (91.34.609.15).

* NOTE: A shower head, jet or bath spout must be added to the order, depending on installation type.

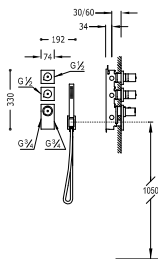

Termostatická baterie podomítková BLOCK SYSTEM

s uzávěrem a regulací průtoku.

- Včetně podomítkového termostatického tělesa
- Ruční sprcha, proti usaz. vod. kamene (034.116.01).
- Flexi hadice SATIN (91.34.609.15).

* POZNÁMKA: Podle typu instalace je nutno přidat k objednávce křepitko, trysky nebo ramínko na vanu.

299.195.03
3 vie/cestná/ways

Cr | *206.353.91 |

299.195.03
4 vie/cestná/ways

Cr | *206.354.91 |



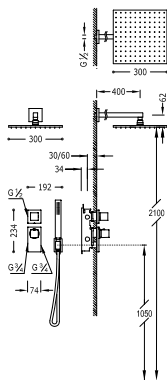

Kit doccia termostatica ad incasso BLOCK SYSTEM

- Con chiusura e regolazione di portata (2 vie).
- Corpo incassato termostatico incluso.
- Doccia fissa 300x300 mm. con snodo (1.34.138.30). Ottone.
- Doccetta anticalcare (202.639.01).
- Flessibile satin (91.34.609.15).

Concealed thermostatic shower kit BLOCK SYSTEM with water shut off and flow control (2 ways).

- Built-in thermostatic body included.
- Fixed shower head 300x300 mm. with ball joint (1.34.138.30).
- Brass.
- Antilime hand shower (202.639.01).
- Shower hose SATIN (91.34.609.15).

Termostatický podomítkový sprchový set BLOCK SYSTEM s uzávěrem a regulací průtoku (2-cestná).

- Včetně podomítkového termostatického tělesa.
- Pevná sprcha 300x300 mm. s kloubem. Materiál mosaz (1.34.138.30).
- Ruční sprcha, proti usaz. vod. kamene (202.639.01).
- Flexi hadice SATIN (91.34.609.15).

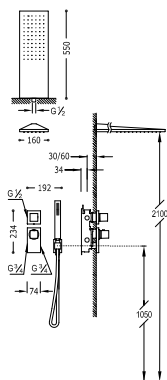

Kit doccia termostatica ad incasso BLOCK SYSTEM

- Con chiusura e regolazione di portata (2 vie).
- Corpo incassato termostatico incluso.
- Doccia acciaio inossidabile da parete 160x550 mm. (299.903.03).
- Doccetta anticalcare (202.639.01).
- Flessibile satin (91.34.609.15).

Concealed thermostatic shower kit BLOCK SYSTEM with water shut off and flow control (2 ways).

- Built-in thermostatic body included.
- Stainless steel wall shower 160x550 mm. (299.903.03).
- Antilime hand shower (202.639.01).
- Shower hose SATIN (91.34.609.15).

Termostatický podomítkový sprchový set BLOCK SYSTEM s uzávěrem a regulací průtoku (2-cestná).

- Včetně podomítkového termostatického tělesa.
- Nástěnné sprchové křepitko z nerez. oceli 160x550 mm. (299.903.03).
- Ruční sprcha, proti usaz. vod. kamene (202.639.01).
- Flexi hadice SATIN (91.34.609.15).



Cr 206.252.01



Cr 206.252.02

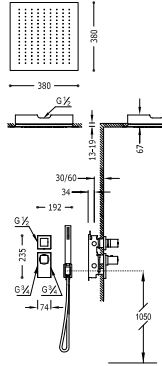

Kit doccia termostatica ad incasso BLOCK SYSTEM

- Con chiusura e regolazione di portata (2 vie).
 - Corpo incassato termostatico incluso.
 - Soffione doccia acciaio inossidabile 380x380 mm. (1.34.944).
 - Doccetta anticalcare (202.639.01).
 - Flessibile satin (91.34.609.15).

Concealed thermostatic shower kit BLOCK SYSTEM with water shut off and flow control (2 ways).

- Built-in thermostatic body included.
 - Stainless steel ceiling shower 380x380 mm. (1.34.944).
 - Antilime hand shower (202.639.01).
 - Shower hose SATIN (91.34.609.15).

Termostatický podomítkový sprchový set BLOCK SYSTEM s uzávěrem a regulací průtoku (2-cestná).

- Včetně podomítkového termostatického tělesa.
 - Sprchové křepítko z nerez. oceli 380x380 mm. (1.34.944).
 - Ruční sprcha, proti usaz. vod. kamene (202.639.01).
 - Flexi hadice SATIN (91.34.609.15).



299.250.45

Cr | **206.252.04** |

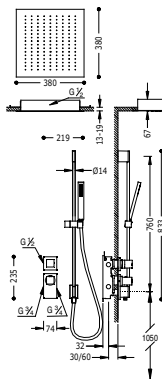

Kit doccia termostatica ad incasso BLOCK SYSTEM

- Con chiusura e regolazione di portata (2 vie).
 - Corpo incassato termostatico incluso.
 - Soffione doccia acciaio inossidabile 380x380 mm. (1.34.944).
 - Barra di scorrimento con presa d'acqua a parete. Lung. 760 mm.
 - Doccetta anticalcare (202.639.01).
 - Flessibile satin (91.34.609.15).

Concealed thermostatic shower kit BLOCK SYSTEM with water shut off and flow control (2 ways).

- Built-in thermostatic body included.
 - Stainless steel ceiling shower 380x380 mm. (1.34.944).
 - Sliding bar with wall water intake. Length: 760 mm.
 - Antilime hand shower (202.639.01).
 - Shower hose SATIN (91.34.609.15).

Termostatický podomítkový sprchový set BLOCK SYSTEM s uzávěrem a regulací průtoku (2-cestná).

- Včetně podomítkového termostatického tělesa.
 - Sprchové křepítko z nerez. oceli 380x380 mm. (1.34.944).
 - Posuvná tyč s nástěnným přívodem vody. Délka 760 mm.
 - Ruční sprcha, proti usaz. vod. kamene (202.639.01).
 - Flexi hadice SATIN (91.34.609.15).



299.250.45

Cr | **206.252.03** |

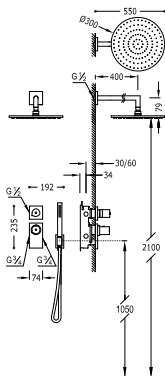

Kit doccia termostatica ad incasso BLOCK SYSTEM

- Con chiusura e regolazione di portata (2 vie).
 - Corpo incassato termostatico incluso.
 - Doccia fissa Ø 300 mm. con snodo. Ottone (1.34.137.30).
 - Doccetta anticalcare (034.116.01).
 - Flessibile satin (91.34.609.15).

Concealed thermostatic shower kit BLOCK SYSTEM with water shut off and flow control (2 ways).

- Built-in thermostatic body included.
 - Fixed shower head Ø 300 mm. with ball joint. Brass (1.34.137.30).
 - Antilime hand shower (034.116.01).
 - Shower hose SATIN (91.34.609.15).

Termostatický podomítkový sprchový set BLOCK SYSTEM s uzávěrem a regulací průtoku (2-cestná).

- Včetně podomítkového termostatického tělesa.
 - Pevná sprcha Ø 300 mm. s kloubem. Materiál Mosaz (1.34.137.30).
 - Ruční sprcha, proti usaz. vod. kamene (034.116.01).
 - Flexi hadice SATIN (91.34.609.15).



299.195.03

Cr 206.352.01

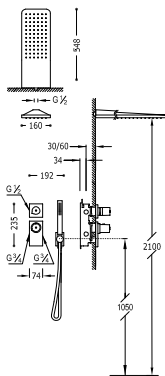

Kit doccia termostatica ad incasso BLOCK SYSTEM

- Con chiusura e regolazione di portata (2 vie).
 - Corpo incassato termostatico incluso.
 - Doccia acciaio inossidabile da parete 160x550 mm. (299.903.06).
 - Doccetta anticalcare (034.116.01).
 - Flessibile satin (91.34.609.15).

Concealed thermostatic shower kit BLOCK SYSTEM with water shut off and flow control (2 ways).

- Built-in thermostatic body included.
 - Stainless steel wall shower 160x550 mm. (299.903.06).
 - Antilime hand shower (034.116.01).
 - Shower hose SATIN (91.34.609.15).

Podomítkový termostatický sprchový set BLOCK SYSTEM s uzávěrem a regulací průtoku (2-cestná).

- Včetně podomítkového termostatického tělesa.
 - Nástěnné sprchové křepitko z nerez. oceli 160x550 mm. (299.903.06).
 - Ruční sprcha, proti usaz. vod. kamene (034.116.01).
 - Flexi hadice SATIN (91.34.609.15).



299.195.03

Cr 206.352.02



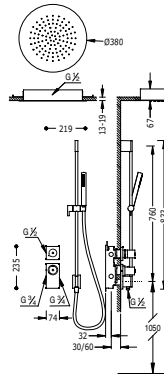

Kit doccia termostatica ad incasso BLOCK SYSTEM

- Con chiusura e regolazione di portata (2 vie).
- Corpo incassato termostatico incluso.
- Soffione doccia acciaio inossidabile Ø 380 mm. (1.34.940).
- Barra di scorrimento con presa d'acqua a parete. Lung. 760 mm.
- Doccetta anticalcare (034.116.01).
- Flexibile satin (91.34.609.15).

Concealed thermostatic shower kit BLOCK SYSTEM with water shut off and flow control (2 ways).

- Built-in thermostatic body included.
- Stainless steel ceiling shower Ø 380 mm. (1.34.940).
- Sliding bar with wall water intake. Length: 760 mm.
- Antilime hand shower (034.116.01).
- Shower hose SATIN (91.34.609.15).

Termostatický podomítkový sprchový set BLOCK SYSTEM s uzávěrem a regulací průtoku (2-cestná).

- Včetně podomítkového termostatického tělesa.
- Sprchové křepítko z nerez. oceli Ø 380 mm. (1.34.940).
- Posuvná tyč s nástěnným přívodem vody. Délka 760 mm.
- Ruční sprcha, proti usaz. vod. kamene (034.116.01).
- Flexi hadice SATIN (91.34.609.15).



299.195.03

Cr | 206.352.03 |

**INSTALLAZIONE CONSIGLIATA
INSTALLATION RECOMMENDED
DOPORUČENÁ INSTALACE**

REF. 206.352.03

Questo è uno schema dell'installazione consigliata per ottimizzare le funzioni del rubinetto.

This is the installation scheme recommended to enjoy the tap functions to the full.

Zde je doporučené schéma pro instalaci, pro zajištění maximálního využití funkcí baterie.

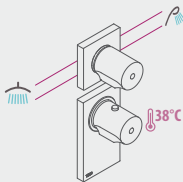

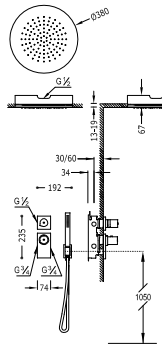
**Kit doccia termostatica ad incasso BLOCK SYSTEM**

Con chiusura e regolazione di portata (2 vie).

- Corpo incassato termostatico incluso.
- Soffione doccia acciaio inossidabile Ø 380 mm. (1.34.940).
- Doccetta anticalcare (034.116.01).
- Flessibile satin (91.34.609.15).

Concealed thermostatic shower kit BLOCK SYSTEM

with water shut off and flow control (2 ways).

- Built-in thermostatic body included.
- Stainless steel ceiling shower Ø 380 mm. (1.34.940).
- Antilime hand shower (034.116.01).
- Shower hose SATIN (91.34.609.15).

Termostatický podomítkový sprchový set BLOCK SYSTEM

s uzávěrem a regulací průtoku (2-cestná).

- Včetně podomítkového termostatického tělesa.
- Sprchové křepitko z nerez. oceli Ø 380 mm. (1.34.940).
- Ruční sprcha, proti usaz. vod. kamene (034.116.01).
- Flexi hadice SATIN (91.34.609.15).



299.195.03

Cr 206.352.04

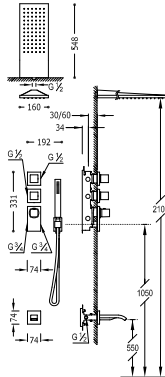

Kit termostatico vasca ad incasso BLOCK SYSTEM

Con chiusura e regolazione di portata (3 vie).

- Corpo incassato termostatico incluso.
- Doccia acciaio inossidabile da parete 160x550 mm. (299.903.03).
- Tubo cascata vasca.
- Doccetta anticalcare (202.639.01).
- Flessibile satin (91.34.609.15).

Concealed thermostatic bath kit BLOCK SYSTEM

with water shut off and flow control (3 ways).

- Built-in thermostatic body included.
- Stainless steel wall shower 160x550 mm. (299.903.03).
- Cascade cast spout.
- Antilime hand shower (202.639.01).
- Shower hose SATIN (91.34.609.15).

Termostatický podomítkový vanový set BLOCK SYSTEM s uzávěrem a regulací průtoku (3-cestná).

- Včetně podomítkového termostatického tělesa.
- Nástěnné sprchové křepítko z nerez. oceli 160x550 mm. (299.903.03).
- Ramínko s kaskádou pro vanu.
- Ruční sprcha, proti usaz. vod. kamene (202.639.01).
- Flexi hadice SATIN (91.34.609.15).



299.250.45

Cr

206.253.01

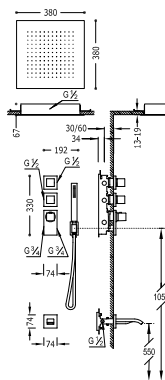

Kit termostatico vasca ad incasso BLOCK SYSTEM

Con chiusura e regolazione di portata (3 vie).

- Corpo incassato termostatico incluso.
- Soffione doccia acciaio inossidabile 380x380 mm. (1.34.944).
- Tubo cascata vasca
- Doccetta anticalcare (202.639.01).
- Flessibile satin (91.34.609.15).

Concealed thermostatic bath kit BLOCK SYSTEM

with water shut off and flow control (3 ways).

- Built-in thermostatic body included.
- Stainless steel ceiling shower 380x380 mm. (1.34.944).
- Cascade cast spout.
- Antilime hand shower (202.639.01).
- Shower hose SATIN (91.34.609.15).

Termostatický podomítkový vanový set BLOCK SYSTEM s uzávěrem a regulací průtoku (3-cestná).

- Včetně podomítkového termostatického tělesa.
- Sprchové křepítko z nerez. oceli 380x380 mm. (1.34.944).
- Ramínko s kaskádou pro vanu.
- Ruční sprcha, proti usaz. vod. kamene (202.639.01).
- Flexi hadice SATIN (91.34.609.15).



299.250.45

Cr

206.253.02



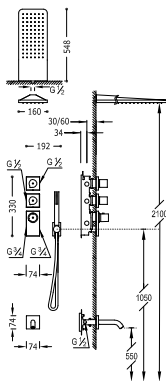

Kit termostatico vasca ad incasso BLOCK SYSTEM

Con chiusura e regolazione di portata (3 vie).

- Corpo incassato termostatico incluso.
- Doccia acciaio inossidabile da parete 160x550 mm. (299.903.06).
- Canna per vasca da bagno.
- Doccetta anticalcare (034.116.01).
- Flessibile satin (91.34.609.15).

Concealed thermostatic bath kit BLOCK SYSTEM with water shut off and flow control (3 ways).

- Built-in thermostatic body included.
- Stainless steel wall shower 160x550 mm. (299.903.06).
- Bath spout.
- Antilime hand shower (034.116.01).
- Shower hose SATIN (91.34.609.15).

Termostatický podomítkový vanový set BLOCK SYSTEM s uzavěrem a regulací průtoku (3-cestná).

- Včetně podomítkového termostatického tělesa.
- Nástěnné sprchové křepitko z nerez. oceli 160x550 mm. (299.903.06).
- Kohoutek pro vanu.
- Ruční sprcha, proti usaz. vod. kamene (034.116.01).
- Flexi hadice SATIN (91.34.609.15).



299.195.03

Cr 206.353.01

INSTALLAZIONE CONSIGLIATA INSTALLATION RECOMMENDED DOPORUČENÁ INSTALACE

REF. 206.353.01

Questo è uno schema dell'installazione consigliata per ottimizzare le funzioni del rubinetto.

This is the installation scheme recommended to enjoy the tap functions to the full.

Zde je doporučené schéma pro instalaci, pro zajištění maximálního využití funkcí baterie.

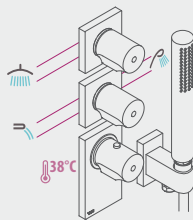



Kit termostatico vasca ad incasso BLOCK SYSTEM

- Con chiusura e regolazione di portata (3 vie).
- Corpo incassato termostatico incluso.
- Soffione doccia acciaio inossidabile Ø 380 mm. (1.34.940).
- Canna per vasca da bagno.
- Doccetta anticalcare (034.116.01).
- Flessibile satin (91.34.609.15).

Concealed thermostatic bath kit BLOCK SYSTEM

- with water shut off and flow control (3 ways).
- Built-in thermostatic body included.
- Stainless steel ceiling shower Ø 380 mm. (1.34.940).
- Bath spout.
- Antilime hand shower (034.116.01).
- Shower hose SATIN (91.34.609.15).

Termostatický podomítkový vanový set BLOCK SYSTEM
s uzávěrem a regulací průtoku (3-cestná).

- Včetně podomítkového termostatického tělesa.
- Sprchové křepítko z nerez. oceli Ø 380 mm. (1.34.940).
- Kohoutek pro vanu.
- Ruční sprcha, proti usaz. vod. kamene (034.116.01).
- Flexi hadice SATIN (91.34.609.15).

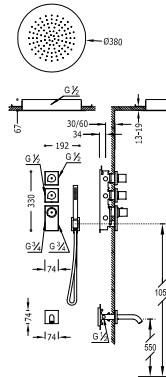

299.195.03

Cr

206.353.02



SHOWER TECHNOLOGY



Il controllo della doccia in un solo tocco **One-touch shower control** **Ovládání sprchy pomocí jediného dotyku**

Minima installazione e montaggio rapido. / **Minimum installation and fast assembly.** / Minimální instalace a rychlá montáž.

Centralina termostatica elettronica. Si può installare a 5-10 metri di distanza del vano doccia. / **Electronic thermostatic regulator. Can be installed 5-10 metres from the shower area.** / Elektronická termostatická jednotka. Možnost instalace do vzdálenosti až 5-10 metrů od sprchového koutu.

Efficienza. Il miscelatore digitale si spegnerà automaticamente quando il prodotto resta aperto per più di 15 minuti. / **Efficiency. The digital mixer tap shuts off automatically when the water has been flowing continuously for more than 15 minutes.** / Výkonnost. Digitální směšovač se vypne, je-li sprcha nepřetržitě puštěna déle než 15 minut.

Sicurezza. In caso di eventuali errori di alimentazione dell'acqua fredda, il sistema si blocca e interrompe il flusso di acqua. / **Safety. In the event of malfunction in the hot or cold water supply, the system locks and the flow of water shuts off.** / Bezpečnost. V případě poruch dodávek studené vody se zařízení zablokuje a průtok vody se zastaví.



Pannelli digitali termostatici
Digital thermostatic control panels
Digitální termostatické panely

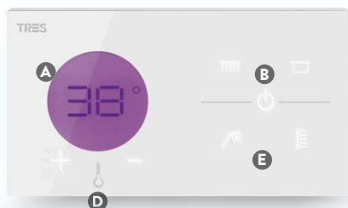
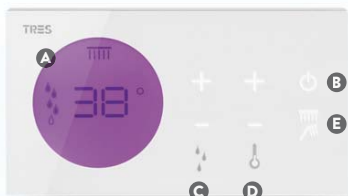

Il livello della temperatura selezionata verrà indicato numericamente e con una scala di colori. / **The selected temperature level is indicated by numbers and a colour scale.** /
 Zvolená teplota je uvedena číselně a na stupnici barev.



Warm System®

La luce del pannello digitale lampeggia mentre si sta raggiungendo la temperatura preselezionata, così saprete esattamente quando la doccia sarà alla temperatura giusta. / **The digital control panel light flashes while it is reaching the preselected temperature, so you will know exactly when your shower is ready.** / Světlo na digitálním panelu po dobu získávání nastavené teploty bliká a víte tedy přesně, kdy je vaše sprcha připravena.

A Schermo informativo / Data display screen / Informační displej.

B Acceso, spento e pausa / On, off and pause / Zapnuto, vypnuto a přerušeno.

C Controllo del flusso / Flow rate control / Nastavení průtoku.

D Selettore di temperatura / Temperature selector switch / Volba teploty.

E Controllo di uscita dell'acqua / Water outlet control / Nastavení výstupu vody.

SHOWER
TECHNOLOGY



Ref. / Nr. / Kód:

2 VIE / WAYS / CESTNÁ

N

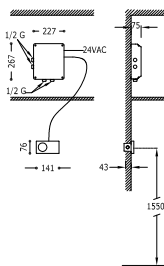
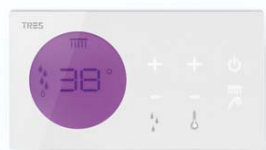

Controllo termostatico elettronico a incasso SHOWER TECHNOLOGY

- Centralina termostatica elettronica inclusa (2 vie)

* NOTA: è obbligatorio aggiungere all'ordine un soffione, doccia a mano, bocchette o una canna per vasca da bagno, a seconda del tipo di installazione.

SHOWER TECHNOLOGY built-in electronic thermostat control

- Electronic thermostat control box included (2 ways)

* NOTE: A spray nozzle, shower head, jet or bath spout must be added to the order, depending on installation type.

Zapuštěné elektronické termostatické ovládání SHOWER TECHNOLOGY

- Zabuďovaná termostatická elektronická kontrolní jednotka (2-cestná)

* POZNÁMKA: Podle typu instalace je nutno přidat k objednávce křípítko, ruční sprchu, trysky nebo ramínko na vanu.

BI 092.862.99

3 VIE / WAYS / CESTNÁ

N

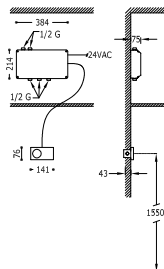
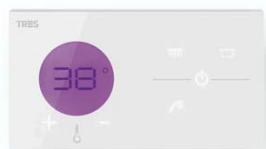

Controllo termostatico elettronico a incasso SHOWER TECHNOLOGY

- Centralina termostatica elettronica inclusa (3 vie)

* NOTA: è obbligatorio aggiungere all'ordine un soffione, doccia a mano, bocchette o una canna per vasca da bagno, a seconda del tipo di installazione.

SHOWER TECHNOLOGY built-in electronic thermostat control

- Electronic thermostat control box included (3 ways)

* NOTE: A spray nozzle, shower head, jet or bath spout must be added to the order, depending on installation type.

Zapuštěné elektronické termostatické ovládání SHOWER TECHNOLOGY

- Zabuďovaná termostatická elektronická kontrolní jednotka (3-cestná)

* POZNÁMKA: Podle typu instalace je nutno přidat k objednávce křípítko, ruční sprchu, trysky nebo ramínko na vanu.

BI 092.863.99

3 VIE / WAYS / CESTNÁ

N

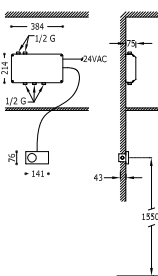
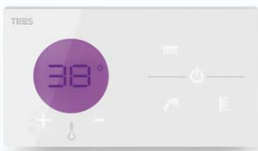

Controllo termostatico elettronico a incasso SHOWER TECHNOLOGY

- Centralina termostatica elettronica inclusa (3 vie).

* NOTA: è obbligatorio aggiungere all'ordine un soffione, doccia a mano, bocchette o una canna per vasca da bagno, a seconda del tipo di installazione.

SHOWER TECHNOLOGY built-in electronic thermostat control

- Electronic thermostatic control box included (3 ways).

* NOTE: A spray nozzle, shower head, jet or bath spout must be added to the order, depending on installation type.

Zapuštěné elektronické termostatické ovládání SHOWER TECHNOLOGY

- Zabudovaná termostatická elektronická kontrolní jednotka (3-cestná).

* POZNÁMKA: Podle typu instalace je nutno přídát k objednávce křepítko, ruční sprchu, trysky nebo ramínko na vanu.

Bl | 092.863.98

4 VIE / WAYS / CESTNÁ

N

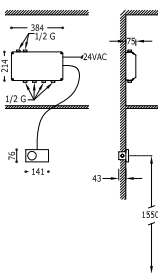
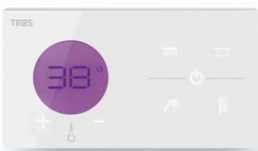

Controllo termostatico elettronico a incasso SHOWER TECHNOLOGY

- Centralina termostatica elettronica inclusa (4 vie).

* NOTA: è obbligatorio aggiungere all'ordine un soffione, doccia a mano, bocchette o una canna per vasca da bagno, a seconda del tipo di installazione.

SHOWER TECHNOLOGY built-in electronic thermostat control

- Electronic thermostatic control box included (4 ways).

* NOTE: A spray nozzle, shower head, jet or bath spout must be added to the order, depending on installation type.

Zapuštěné elektronické termostatické ovládání SHOWER TECHNOLOGY

- Zabudovaná termostatická elektronická kontrolní jednotka (4-cestná).

* POZNÁMKA: Podle typu instalace je nutno přídát k objednávce křepítko, ruční sprchu, trysky nebo ramínko na vanu.

Bl | 092.864.99

SHOWER
TECH.



N

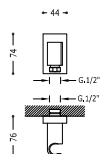

Supporto per doccia

con presa d'acqua a parete e valvola antiritorno

Shower holder

with wall water outlet and check valve.

Úchyt ruční sprchy se stěnovou přípojkou vody s nastavitelným výstupem pro vodu a zpětným ventilem.

Cr | 207.182.01

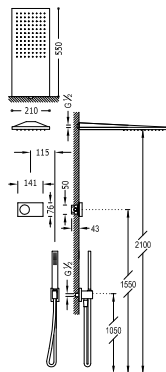

Kit elettronico per doccia termostatico da incasso SHOWER TECHNOLOGY

- Centralina termostatica elettronica inclusa (2 vie).
- Doccia acciaio inossidabile da parete 210x550 mm. (299.903.02).
- Supporto per doccia (207.182.01).
- Doccetta anticalcare (202.639.01).
- Flessibile satin (91.34.609.15).

Built-in electronic thermostatic shower kit SHOWER TECHNOLOGY

- Electronic thermostatic control box included (2 ways).
- Stainless steel wall shower 210x550 mm. (299.903.02).
- Elbow wall (207.182.01).
- Antilime hand shower (202.639.01).
- Shower hose SATIN (91.34.609.15).

Termostatický podomítkový elektronický sprchový set SHOWER TECHNOLOGY

- Zabudovaná termostatická elektronická kontrolní jednotka (2-cestná).
- Nástěnné sprchové křepitko z nerez. oceli 210x550 mm. (299.903.02).
- Držák s nástěnným přívodem vody (207.182.01).
- Ruční sprcha, proti usaz. vod. kamene (202.639.01).
- Flexi hadice SATIN (91.34.609.15).



Cr 092.865.51

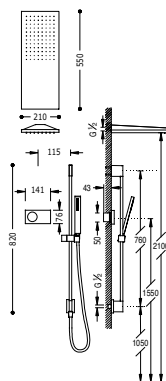

Kit elettronico per doccia termostatico da incasso SHOWER TECHNOLOGY

- Centralina termostatica elettronica inclusa (2 vie).
- Doccia acciaio inossidabile da parete 210x550 mm. (299.903.02).
- Barra di scorrimento con presa d'acqua a parete. Lung. 760 mm (034.932.99).
- Doccetta anticalcare (202.639.01).
- Flessibile satin (91.34.609.15).

Built-in electronic thermostatic shower kit SHOWER TECHNOLOGY

- Electronic thermostatic control box included (2 ways).
- Stainless steel wall shower 210x550 mm. (299.903.02).
- Sliding bar with wall water intake. Length: 760 mm. (034.932.99).
- Antilime hand shower (202.639.01).
- Shower hose SATIN (91.34.609.15).

Termostatický podomítkový elektronický sprchový set SHOWER TECHNOLOGY

- Zabudovaná termostatická elektronická kontrolní jednotka (2-cestná).
- Nástěnné sprchové křepitko z nerez. oceli 210x550 mm. (299.903.02).
- Posuvná tyč s nástěnným přívodem vody. Délka 760 mm. (034.932.99).
- Ruční sprcha, proti usaz. vod. kamene (202.639.01).
- Flexi hadice SATIN (91.34.609.15).



Cr 092.865.80

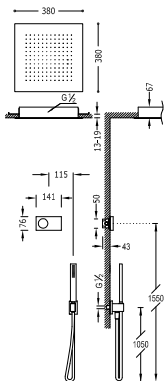

Kit elettronico per doccia termostatico da incasso
SHOWER TECHNOLOGY

- Centralina termostatica elettronica inclusa (2 vie).
- Soffione doccia acciaio inossidabile 380x380 mm. (1.34.944).
- Supporto per doccia (207.182.01).
- Doccetta anticalcare (202.639.01).
- Flessibile satin (91.34.609.15).

Built-in electronic thermostatic shower kit
SHOWER TECHNOLOGY

- Electronic thermostatic control box included (2 ways).
- Stainless steel ceiling shower 380x380 mm. (1.34.944).
- Elbow wall (207.182.01).
- Antilime hand shower (202.639.01).
- Shower hose SATIN (91.34.609.15).

Termostatický podomítkový elektronický sprchový set
SHOWER TECHNOLOGY

- Zabudovaná termostatická elektronická kontrolní jednotka (2-cestná).
- Sprchové kropítko z nerez. oceli 380x380 mm. (1.34.944).
- Držák s nástěnným přívodem vody (207.182.01).
- Ruční sprcha, proti usaz. vod. kamene (202.639.01).
- Flexi hadice SATIN (91.34.609.15).

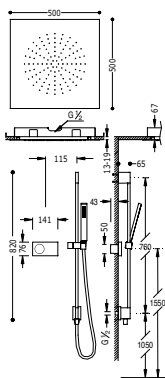

Kit elettronico per doccia termostatico da incasso
SHOWER TECHNOLOGY

- Centralina termostatica elettronica inclusa (2 vie).
- Soffione doccia acciaio inossidabile 500x500 mm. (299.953.02).
- Barra di scorrimento con presa d'acqua a parete. Lung. 760 mm (034.932.99).
- Doccetta anticalcare (202.639.01).
- Flessibile satin (91.34.609.15).

Built-in electronic thermostatic shower kit
SHOWER TECHNOLOGY

- Electronic thermostatic control box included (2 ways).
- Stainless steel ceiling shower 500x500 mm. (299.953.02).
- Sliding bar with wall water intake. Length: 760 mm. (034.932.99).
- Antilime hand shower (202.639.01).
- Shower hose SATIN (91.34.609.15).

Termostatický podomítkový elektronický sprchový set
SHOWER TECHNOLOGY

- Zabudovaná termostatická elektronická kontrolní jednotka (2-cestná).
- Sprchové kropítko z nerez. oceli 500x500 mm. (299.953.02).
- Posuvná tyč s nástěnným přívodem vody. Délka 760 mm. (034.932.99).
- Ruční sprcha, proti usaz. vod. kamene (202.639.01).
- Flexi hadice SATIN (91.34.609.15).



Cr | 092.865.52 |



Cr | 092.865.81 |

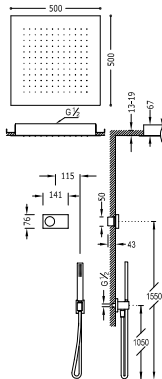

Kit elettronico per doccia termostatico da incasso
SHOWER TECHNOLOGY

- Centralina termostatica elettronica inclusa (2 vie).
- Soffione doccia acciaio inossidabile 500x500 mm. (1.34.951).
- Supporto per doccia (207.182.01).
- Doccetta anticalcare (202.639.01).
- Flessibile satin (91.34.609.15).

Built-in electronic thermostatic shower kit
SHOWER TECHNOLOGY

- Electronic thermostatic control box included (2 ways).
- Stainless steel ceiling shower 500x500 mm. (1.34.951).
- Elbow wall (207.182.01).
- Antilime hand shower (202.639.01).
- Shower hose SATIN (91.34.609.15).

Termostatický podomítkový elektronický sprchový set
SHOWER TECHNOLOGY

- Zabudovaná termostatická elektronická kontrolní jednotka (2-cestná).
- Sprchové kropitko z nerez. oceli 500x500 mm. (1.34.951).
- Držák s nástěnným přívodem vody (207.182.01).
- Ruční sprcha, proti usaz. vod. kamene (202.639.01).
- Flexní hadice SATIN (91.34.609.15).



Cr 092.865.61

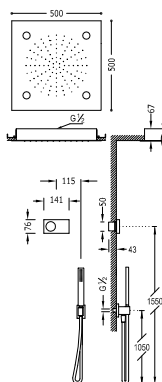

Kit elettronico per doccia termostatico da incasso
SHOWER TECHNOLOGY CHROMOTHERAPY

- Centralina termostatica elettronica inclusa (2 vie).
- Soffione doccia anticalcare 500x500 mm. (299.962.01).
- Supporto per doccia (207.182.01).
- Doccetta anticalcare (202.639.01).
- Flessibile satin (91.34.609.15).

Built-in electronic thermostatic shower kit
SHOWER TECHNOLOGY CHROMOTHERAPY

- Electronic thermostatic control box included (2 ways).
- Ceiling shower antilime 500x500 mm. (299.962.01).
- Elbow wall (207.182.01).
- Antilime hand shower (202.639.01).
- Shower hose SATIN (91.34.609.15).

Termostatický podomítkový elektronický sprchový set
SHOWER TECHNOLOGY CHROMOTHERAPY

- Zabudovaná termostatická elektronická kontrolní jednotka (2-cestná).
- Sprchové kropitko z nerez. oceli 500x500 mm. (299.962.01).
- Držák s nástěnným přívodem vody (207.182.01).
- Ruční sprcha, proti usaz. vod. kamene (202.639.01).
- Flexní hadice SATIN (91.34.609.15).



Cr 092.865.62



Kit elettronico per doccia termostatico da incasso
SHOWER TECHNOLOGY

- Centralina termostatica elettronica inclusa (2 vie).
- Doccia fissa 300x300 mm. con snodo. Ottone (1.34.138.30).
- Supporto per doccia (207.182.01).
- Doccetta anticalcare (202.639.01).
- Flessibile satin (91.34.609.15).

Built-in electronic thermostatic shower kit
SHOWER TECHNOLOGY

- Electronic thermostatic control box included (2 ways).
- Fixed shower head 300x300 mm. with ball joint. Brass

(1.34.138.30).

- Elbow wall (207.182.01).
- Antilime hand shower (202.639.01).
- Shower hose SATIN (91.34.609.15).

Termostatický podomítkový elektronický sprchový set
SHOWER TECHNOLOGY

- Zabudovaná termostatická elektronická kontrolní jednotka (2-cestná).

· Pevná sprcha 300x300 mm. s kloubem. Materiál Mosaz (1.34.138.30).

- Držák s nástěnným přívodem vody (207.182.01).
- Ruční sprcha, proti usaz. vod. kamene (202.639.01).
- Flexi hadice SATIN (91.34.609.15).

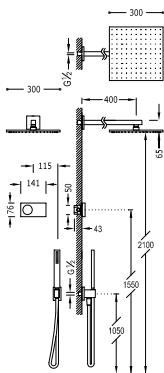

Kit elettronico per doccia termostatico da incasso
SHOWER TECHNOLOGY

- Centralina termostatica elettronica inclusa (2 vie).
- Doccia fissa 300x300 mm. con snodo. Ottone (1.34.138.30).
- Supporto per doccia (207.182.01).
- Doccetta anticalcare (202.639.01).
- Flessibile satin (91.34.609.15).

Built-in electronic thermostatic shower kit
SHOWER TECHNOLOGY

- Electronic thermostatic control box included (2 ways).
- Fixed shower head 300x300 mm. with ball joint. Brass

(1.34.138.30).

- Elbow wall (207.182.01).
- Antilime hand shower (202.639.01).
- Shower hose SATIN (91.34.609.15).

Termostatický podomítkový elektronický sprchový set
SHOWER TECHNOLOGY

- Zabudovaná termostatická elektronická kontrolní jednotka (2-cestná).

· Pevná sprcha 300x300 mm. s kloubem. Materiál Mosaz (1.34.138.30).

- Držák s nástěnným přívodem vody (207.182.01).
- Ruční sprcha, proti usaz. vod. kamene (202.639.01).
- Flexi hadice SATIN (91.34.609.15).

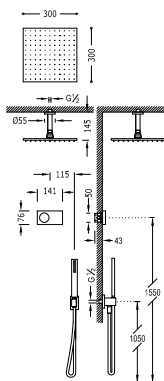

Cr | 092.865.63 |



Cr | 092.865.64 |

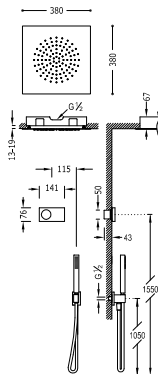

Kit elettronico per doccia termostatico da incasso
SHOWER TECHNOLOGY

- Centralina termostatica elettronica inclusa (2 vie).
- Soffione doccia acciaio inossidabile 380x380 mm. (299.953.01).
- Supporto per doccia (207.182.01).
- Doccetta anticalcare (202.639.01).
- Flessibile satin (91.34.609.15).

Built-in electronic thermostatic shower kit
SHOWER TECHNOLOGY

- Electronic thermostatic control box included (2 ways).
- Stainless steel ceiling shower 380x380 mm. (299.953.01).
- Elbow wall (207.182.01).
- Antilime hand shower (202.639.01).
- Shower hose SATIN (91.34.609.15).

Termostatický podomítkový elektronický sprchový set
SHOWER TECHNOLOGY

- Zabudovaná termostatická elektronická kontrolní jednotka (2-cestná).
- Sprchové kropítko z nerez. oceli 380x380 mm. (299.953.01).
- Držák s nástěnným přívodem vody (207.182.01).
- Ruční sprcha, proti usaz. vod. kamene (202.639.01).
- Flexi hadice SATIN (91.34.609.15).



Cr 092.865.84

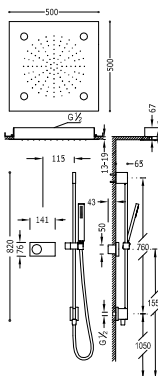

Kit elettronico per doccia termostatico da incasso
SHOWER TECHNOLOGY CHROMOTHERAPY

- Centralina termostatica elettronica inclusa (2 vie).
- Soffione doccia acciaio inossidabile 500x500 mm. (299.962.01).
- Barra di scorrimento con presa d'acqua a parete. Lung. 760 mm (034.932.99).
- Doccetta anticalcare (202.639.01).
- Flessibile satin (91.34.609.15).

Built-in electronic thermostatic shower kit
SHOWER TECHNOLOGY CHROMOTHERAPY

- Electronic thermostatic control box included (2 ways).
- Stainless steel ceiling shower 500x500 mm. (299.962.01).
- Sliding bar with wall water intake. Length: 760 mm. (034.932.99).
- Antilime hand shower (202.639.01).
- Shower hose SATIN (91.34.609.15).

Termostatický podomítkový elektronický sprchový set
SHOWER TECHNOLOGY CHROMOTHERAPY

- Zabudovaná termostatická elektronická kontrolní jednotka (2-cestná).
- Sprchové kropítko z nerez. oceli 500x500 mm. (299.962.01).
- Posuvná tyč s nástěnným přívodem vody. Délka 760 mm. (034.932.99).
- Ruční sprcha, proti usaz. vod. kamene (202.639.01).
- Flexi hadice SATIN (91.34.609.15).



Cr 092.865.85



Kit elettronico per vasca da bagno termostatico da incasso
SHOWER TECHNOLOGY

- Centralina termostatica elettronica inclusa (2 vie).
- Tubo cascata vasca acciaio inossidabile (299.903.04).
- Supporto per doccia (207.182.01).
- Doccetta anticalcare (202.639.01).
- Flessibile satin (91.34.609.15).

Built-in electronic thermostatic bath kit
SHOWER TECHNOLOGY

- Electronic thermostatic control box included (2 ways).
- Steel cascade cast spout (299.903.04).
- Elbow wall (207.182.01).
- Antilime hand shower (202.639.01).
- Shower hose SATIN (91.34.609.15).

Termostatický podomítkový elektronický vanový set
SHOWER TECHNOLOGY

- Zabudovaná termostatická elektronická kontrolní jednotka (2-cestná).
- Vanový rámisko s kaskádou z nerez. oceli (299.903.04).
- Držák s nástěnným přívodem vody (207.182.01).
- Ruční sprcha, proti usaz. vod. kamene (202.639.01).
- Flexi hadice SATIN (91.34.609.15).

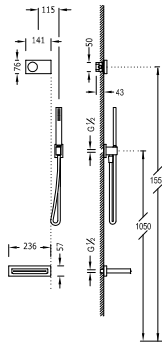

Cr | 092.865.53 |

SHOWER
TECH.
2



Kit elettronico per vasca da bagno termostatico da incasso
SHOWER TECHNOLOGY

- Centralina termostatica elettronica inclusa (2 vie).
- Tubo cascata vasca acciaio inossidabile (299.903.04).
- Doccetta anticalcare (202.639.01).
- Flessibile doppia graffatura.

Built-in electronic thermostatic bath kit
SHOWER TECHNOLOGY

- Electronic thermostatic control box included (2 ways).
- Steel cascade cast spout (299.903.04).
- Antilime hand shower (202.639.01).
- Double interlocked shower hose.

Termostatický podomítkový elektronický vanový set
SHOWER TECHNOLOGY

- Zabudovaná termostatická elektronická kontrolní jednotka (2-cestná).
- Vanové rámisko s kaskádou z nerez. oceli (299.903.04).
- Ruční sprcha, proti usaz. vod. kamene (202.639.01).
- Flexi hadice s dvojitým opletem.

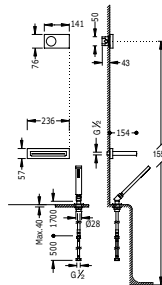

Cr | 092.865.70 |

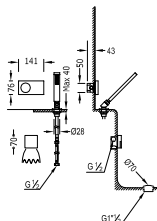

Kit elettronico per vasca da bagno termostatico da incasso SHOWER TECHNOLOGY

- Centralina termostatica elettronica inclusa (2 vie).
- Scarico vasca e valvola di riempimento quadrata A CASCATA con troppopieno (1.34.534.40).
- Sifone PVC vasca (1.34.634.60).
- Doccetta anticalcare (202.639.01).
- Flessibile doppia graffatura.

Built-in electronic thermostatic bath kit SHOWER TECHNOLOGY

- Electronic thermostatic control box included (2 ways).
- Bath drain and square CASCADE filling valve with overflow drain (1.34.534.40).
- Bath PVC drain trap (1.34.634.60).
- Antilime hand shower (202.639.01).
- Double interlocked shower hose.

Termostatický podomítkový elektronický vanový set SHOWER TECHNOLOGY

- Zabudovaná termostatická elektronická kontrolní jednotka (2-cestná).
- Odtoková a napouštěcí vanová hranatá KASKÁDA s přepadem (1.34.534.40).
- Vanový sifon z PVC (1.34.634.60).
- Ruční sprcha, proti usaz.vod. kamene (202.639.01).
- Flexi hadice s dvojitým opletem.



Cr 092.865.71

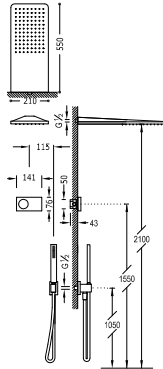

Kit elettronico per doccia termostatico da incasso
SHOWER TECHNOLOGY

- Centralina termostatica elettronica inclusa (2 vie).
- Doccia acciaio inossidabile da parete 210x550 mm. (299.903.07).
- Supporto per doccia (207.182.01).
- Doccetta anticalcare (034.116.01).
- Flessibile satin (91.34.609.15).

Built-in electronic thermostatic shower kit
SHOWER TECHNOLOGY

- Electronic thermostatic control box included (2 ways).
- Stainless steel wall shower 210x550 mm. (299.903.07).
- Elbow wall (207.182.01).
- Antilime hand shower (034.116.01).
- Shower hose SATIN (91.34.609.15).

Termostatický podomítkový elektronický sprchový set
SHOWER TECHNOLOGY

- Zabudovaná termostatická elektronická kontrolní jednotka (2-cestná).
- Nástěnné sprchové křepitko z nerez. oceli 210x550 mm. (299.903.07).
- Držák s nástěnným přívodem vody (207.182.01).
- Ruční sprcha, proti usaz. vod. kamene (034.116.01).
- Flexi hadice SATIN (91.34.609.15).

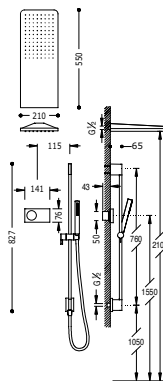

Kit elettronico per doccia termostatico da incasso
SHOWER TECHNOLOGY

- Centralina termostatica elettronica inclusa (2 vie).
- Doccia acciaio inossidabile da parete 210x550 mm. (299.903.07).
- Barra di scorrimento con presa d'acqua a parete. Lung. 760 mm (034.931.99).
- Doccetta anticalcare (034.116.01).
- Flessibile satin (91.34.609.15).

Built-in electronic thermostatic shower kit
SHOWER TECHNOLOGY

- Electronic thermostatic control box included (2 ways).
- Stainless steel wall shower 210x550 mm. (299.903.07).
- Sliding bar with wall water intake. Length: 760 mm. (034.931.99).
- Antilime hand shower (034.116.01).
- Shower hose SATIN (91.34.609.15).

Termostatický podomítkový elektronický sprchový set
SHOWER TECHNOLOGY

- Zabudovaná termostatická elektronická kontrolní jednotka (2-cestná).
- Nástěnné sprchové křepitko z nerez. oceli 210x550 mm. (299.903.07).
- Posuvná tyč s nástěnným přívodem vody. Délka 760 mm. (034.931.99).
- Ruční sprcha, proti usaz. vod. kamene (034.116.01).
- Flexi hadice SATIN (91.34.609.15).

Cr | 092.865.54



Cr | 092.865.82



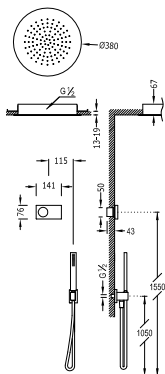

Kit elettronico per doccia termostatico da incasso
SHOWER TECHNOLOGY

- Centralina termostatica elettronica inclusa (2 vie).
- Soffione doccia acciaio inossidabile Ø 380 mm. (1.34.940).
- Supporto per doccia (207.182.01).
- Doccetta anticalcare (034.116.01).
- Flessibile satin (91.34.609.15).

Built-in electronic thermostatic shower kit
SHOWER TECHNOLOGY

- Electronic thermostatic control box included (2 ways).
- Stainless steel ceiling shower Ø 380 mm. (1.34.940).
- Elbow wall (207.182.01).
- Antilime hand shower (034.116.01).
- Shower hose SATIN (91.34.609.15).

Termostatický podomítkový elektronický sprchový set
SHOWER TECHNOLOGY

- Zabudovaná termostatická elektronická kontrolní jednotka (2-cestná).
- Sprchové kropítko z nerez. oceli Ø 380 mm. (1.34.940).
- Držák s nástěnným přívodem vody (207.182.01).
- Ruční sprcha, proti usaz. vod. kamene (034.116.01).
- Flexi hadice SATIN (91.34.609.15).



Cr 092.865.55

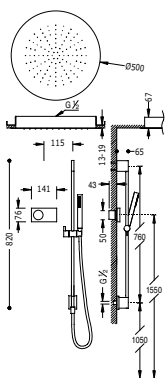

Kit elettronico per doccia termostatico da incasso
SHOWER TECHNOLOGY

- Centralina termostatica elettronica inclusa (2 vie).
- Soffione doccia acciaio inossidabile Ø 500 mm. (1.34.950).
- Barra di scorrimento con presa d'acqua a parete. Lung. 760 mm (034.931.99).
- Doccetta anticalcare (034.116.01).
- Flessibile satin (91.34.609.15).

Built-in electronic thermostatic shower kit
SHOWER TECHNOLOGY

- Electronic thermostatic control box included (2 ways).
- Stainless steel ceiling shower Ø 500 mm. (1.34.950).
- Sliding bar with wall water intake. Length: 760 mm. (034.931.99).
- Antilime hand shower (034.116.01).
- Shower hose SATIN (91.34.609.15).

Termostatický podomítkový elektronický sprchový set
SHOWER TECHNOLOGY

- Zabudovaná termostatická elektronická kontrolní jednotka (2-cestná).
- Sprchové kropítko z nerez. oceli Ø 500 mm. (1.34.950).
- Posuvná tyč s nástěnným přívodem vody. Délka 760 mm. (034.931.99).
- Ruční sprcha, proti usaz. vod. kamene (034.116.01).
- Flexi hadice SATIN (91.34.609.15).



Cr 092.865.83

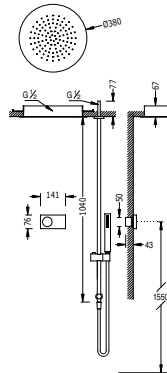

Kit elettronico per doccia termostatico da incasso
SHOWER TECHNOLOGY

- Centralina termostatica elettronica inclusa (2 vie).
- Soffione doccia acciaio inossidabile Ø 380 mm. (1.34.940).
- Barra di scorrimento con presa d'acqua a soffitto. Lung. 1.040 mm.
- Doccetta anticalcare (034.116.01).
- Flessibile satin (91.34.609.15).

Built-in electronic thermostatic shower kit
SHOWER TECHNOLOGY

- Electronic thermostatic control box included (2 ways).
- Stainless steel ceiling shower Ø 380 mm. (1.34.940).
- Sliding bar with ceiling water intake. Length: 1.040 mm.
- Antilime hand shower (034.116.01).
- Shower hose SATIN (91.34.609.15).

Termostatický podomítkový elektronický sprchový set
SHOWER TECHNOLOGY

- Zabudovaná termostatická elektronická kontrolní jednotka (2-cestná).
- Sprchové kropítko z nerez. oceli Ø 380 mm. (1.34.940).
- Posuvná tyč se stropním přívodem vody. Délka 1040 mm.
- Ruční sprcha, proti usaz. vod. kamene (034.116.01).
- Flexi hadice SATIN (91.34.609.15).

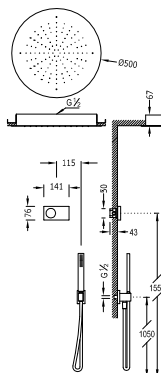

Kit elettronico per doccia termostatico da incasso
SHOWER TECHNOLOGY

- Centralina termostatica elettronica inclusa (2 vie).
- Soffione doccia acciaio inossidabile Ø 500 mm. (1.34.950).
- Supporto per doccia (207.182.01).
- Doccetta anticalcare (034.116.01).
- Flessibile satin (91.34.609.15).

Built-in electronic thermostatic shower kit
SHOWER TECHNOLOGY

- Electronic thermostatic control box included (2 ways).
- Stainless steel ceiling shower Ø 500 mm. (1.34.950).
- Elbow wall (207.182.01).
- Antilime hand shower (034.116.01).
- Shower hose SATIN (91.34.609.15).

Termostatický podomítkový elektronický sprchový set
SHOWER TECHNOLOGY

- Zabudovaná termostatická elektronická kontrolní jednotka (2-cestná).
- Sprchové kropítko z nerez. oceli Ø 500 mm. (1.34.950).
- Držák s nástěnným přívodem vody (299.351.01).
- Ruční sprcha, proti usaz. vod. kamene (034.116.01).
- Flexi hadice SATIN (91.34.609.15).



Cr | 092.865.65



Cr | 092.865.57

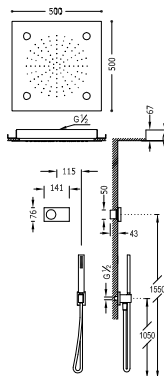

Kit elettronico per doccia termostatico da incasso
SHOWER TECHNOLOGY CHROMOTHERAPY

- Centralina termostatica elettronica inclusa (2 vie).
- Soffione doccia anticalcare 500x500 mm. (299.962.01).
- Supporto per doccia (207.182.01).
- Doccetta anticalcare (034.116.01).
- Flessibile satin (91.34.609.15).

Built-in electronic thermostatic shower kit
SHOWER TECHNOLOGY CHROMOTHERAPY

- Electronic thermostatic control box included (2 ways).
- Ceiling shower antilime 500x500 mm. (299.962.01).
- Elbow wall (207.182.01).
- Antilime hand shower (034.116.01).
- Shower hose SATIN (91.34.609.15).

Termostatický podomítkový elektronický sprchový set
SHOWER TECHNOLOGY CHROMOTHERAPY

- Zabudovaná termostatická elektronická kontrolní jednotka (2-cestná).
- Sprchové křepítko z nerez. oceli 500x500 mm. (299.962.01).
- Držák s nástěnným přívodem vody (299.351.01).
- Ruční sprcha, proti usaz. vod. kamene (034.116.01).
- Flexi hadice SATIN (91.34.609.15).



Cr 092.865.66

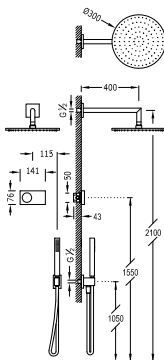

Kit elettronico per doccia termostatico da incasso
SHOWER TECHNOLOGY

- Centralina termostatica elettronica inclusa (2 vie).
- Doccia fissa Ø 300 mm. con snodo. Ottone (1.34.137.30).
- Supporto per doccia (207.182.01).
- Doccetta anticalcare (034.116.01).
- Flessibile satin (91.34.609.15).

Built-in electronic thermostatic shower kit
SHOWER TECHNOLOGY

- Electronic thermostatic control box included (2 ways).
- Fixed shower head Ø 300 mm. with ball joint. Brass (1.34.137.30).
- Elbow wall (207.182.01).
- Antilime hand shower (034.116.01).
- Shower hose SATIN (91.34.609.15).

Termostatický podomítkový elektronický sprchový set
SHOWER TECHNOLOGY

- Zabudovaná termostatická elektronická kontrolní jednotka (2-cestná).
- Pevná sprcha Ø 300 mm. s kloubem. Materiál Mosaz (1.34.137.30).
- Držák s nástěnným přívodem vody (299.351.01).
- Ruční sprcha, proti usaz. vod. kamene (034.116.01).
- Flexi hadice SATIN (91.34.609.15).



Cr 092.865.58

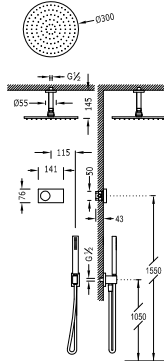

Kit elettronico per doccia termostatico da incasso
SHOWER TECHNOLOGY

- Centralina termostatica elettronica inclusa (2 vie).
- Doccia fissa Ø 300 mm. con snodo. Ottone (1.34.137.30).
- Supporto per doccia (207.182.01).
- Doccetta anticalcare (034.116.01).
- Flessibile satin (91.34.609.15).

Built-in electronic thermostatic shower kit
SHOWER TECHNOLOGY

- Electronic thermostatic control box included (2 ways).
- Fixed shower head Ø 300 mm. with ball joint. Brass (1.34.137.30).
- Elbow wall (207.182.01).
- Antilime hand shower (034.116.01).
- Shower hose SATIN (91.34.609.15).

Termostatický podomítkový elektronický sprchový set
SHOWER TECHNOLOGY

- Zabudovaná termostatická elektronická kontrolní jednotka (2-cestná).
- Pevná sprcha Ø 300 mm. s kloubem. Materiál Mosaz (1.34.137.30).
- Držák s nástěnným přívodem vody (299.351.01).
- Ruční sprcha, proti usaz. vod. kamene (034.116.01).
- Flexi hadice SATIN (91.34.609.15).



Cr | 092.865.67 |

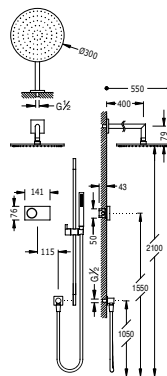

Kit elettronico per doccia termostatico da incasso
SHOWER TECHNOLOGY

- Centralina termostatica elettronica inclusa (2 vie).
- Doccia fissa Ø 300 mm. con snodo. Ottone (1.34.137.30).
- Asta antiscivolo lunga 760 mm. (034.637.01).
- Doccetta anticalcare (034.116.01).
- Flessibile satin (91.34.609.15).

Built-in electronic thermostatic shower kit
SHOWER TECHNOLOGY

- Electronic thermostatic control box included (2 ways).
- Fixed shower head Ø 300 mm. with ball joint. Brass (1.34.137.30).
- Bar-shower antilime. long. 760 mm. (034.637.01).
- Antilime hand shower (034.116.01).
- Shower hose SATIN (91.34.609.15).

Termostatický podomítkový elektronický sprchový set
SHOWER TECHNOLOGY

- Zabudovaná termostatická elektronická kontrolní jednotka (2-cestná).
- Pevná sprcha Ø 300 mm. s kloubem. Materiál Mosaz (1.34.137.30).
- Posuvná tyč 760 mm. (034.637.01).
- Ruční sprcha, proti usaz. vod. kamene (034.116.01).
- Flexi hadice SATIN (91.34.609.15).



Cr | 092.865.68 |

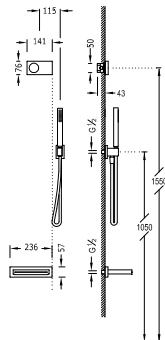

Kit elettronico per vasca da bagno termostatico da incasso
SHOWER TECHNOLOGY

- Centralina termostatica elettronica inclusa (2 vie).
- Tubo cascata vasca acciaio inossidabile (299.903.04).
- Supporto per doccia (207.182.01).
- Doccetta anticalcare (034.116.01).
- Flessibile satin (91.34.609).

Built-in electronic thermostatic bath kit
SHOWER TECHNOLOGY

- Electronic thermostatic control box included (2 ways).
- Steel cascade cast spout (299.903.04).
- Elbow wall (207.182.01).
- Antilime hand shower (034.116.01).
- Shower hose SATIN (91.34.609).

Termostatický podomítkový elektronický vanový set
SHOWER TECHNOLOGY

- Zabudovaná termostatická elektronická kontrolní jednotka (2-cestná).
- Vanové ramínko s kaskádou z nerez. Oceli (299.903.04).
- Držák s nástěnným přívodem vody (299.351.01).
- Ruční sprcha, proti usaz. vod. kamene (034.116.01).
- Flexi hadice SATIN (91.34.609).



Cr 092.865.56

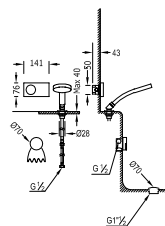

Kit elettronico per vasca da bagno termostatico da incasso
SHOWER TECHNOLOGY

- Centralina termostatica elettronica inclusa (2 vie).
- Scarico vasca e valvola di riempimento rotonda A CASCATA con troppopieno (1.34.534.30).
- Sifone PVC vasca (1.34.634.60).
- Doccetta massaggio, 5 posizioni (299.631.06).
- Flessibile doppia graffatura.

Built-in electronic thermostatic bath kit
SHOWER TECHNOLOGY

- Electronic thermostatic control box included (2 ways).
- Bath drain and round CASCADE filling valve with overflow drain. (1.34.534.30).
- Bath PVC drain trap (1.34.634.60).
- Massage shower, 5 positions (299.631.06).
- Double interlocked shower hose.

Termostatický podomítkový elektronický vanový set
SHOWER TECHNOLOGY

- Zabudovaná termostatická elektronická kontrolní jednotka (2-cestná).
- Odtoková a napouštěcí vanová kulatá KASKÁDA s přepadem (1.34.534.30).
- Vanový sifon z PVC (1.34.634.60).
- Masážní sprcha, 5 funkcí (299.631.06).
- Flexi hadice s dvojitým opletem.



Cr 092.865.73

N

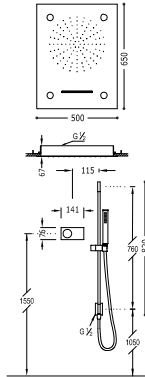

Kit elettronico per doccia termostatico da incasso

SHOWER TECHNOLOGY CHROMOTHERAPY

- Centralina termostatica elettronica inclusa (3 vie).
- Soffione doccia acciaio inossidabile con cascata 500x650 mm. 3 funzioni (299.972.01).
- Barra di scorrimento con presa d'acqua a parete. Lung. 760 mm (034.932-99).
- Doccetta anticalcare (202.639.01).
- Flessibile satin (91.34.609.15).

IMPORTANTE: Montare uno scarico di >50 l/min.

**Built-in electronic thermostatic shower kit
SHOWER TECHNOLOGY CHROMOTHERAPY**

- Electronic thermostatic control box included (3 ways).
- Stainless steel ceiling shower with cascade 500x650 mm. 3 positions (299.972.01).
- Sliding bar with wall water intake. Length: 760 mm. (034.932-99).
- Antilime hand shower (202.639.01).
- Shower hose SATIN (91.34.609.15).

Termostatický podomítkový elektronický sprchový set
SHOWER TECHNOLOGY CHROMOTHERAPY

- Zabudovaná termostatická elektronická kontrolní jednotka (3-cestná).
- Sprchové kropítko z nerez. oceli s kaskádou 500x650 mm. 3 funkce (299.972.01).
- Posuvná tyč s nástěnným přívodem vody. Délka 760 mm. (034.932-99).
- Ruční sprcha, proti usaz. vod. kamene (202.639.01).
- Flexi hadice SATIN (91.34.609.15).

DŮLEŽITÉ: Použijte odtokovou trubici pro průtok >50 l/min.



Cr | 092.863.01

SHOWER
TECH.

N

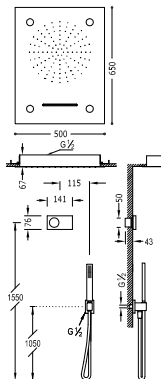

Kit elettronico per doccia termostatico da incasso

SHOWER TECHNOLOGY CHROMOTHERAPY

- Centralina termostatica elettronica inclusa (3 vie).
- Soffione doccia acciaio inossidabile con cascata 500x650 mm. 3 funzioni (299.972.01).
- Supporto per doccia (207.182.01).
- Doccetta anticalcare (202.639.01).
- Flessibile satin (91.34.609.15).

IMPORTANTE: Montare uno scarico di >50 l/min.

**Built-in electronic thermostatic shower kit
SHOWER TECHNOLOGY CHROMOTHERAPY**

- Electronic thermostatic control box included (3 ways).
- Stainless steel ceiling shower with cascade 500x650 mm. 3 positions (299.972.01).
- Elbow wall (207.182.01).
- Antilime hand shower (202.639.01).
- Shower hose SATIN (91.34.609.15).

Termostatický podomítkový elektronický sprchový set
SHOWER TECHNOLOGY CHROMOTHERAPY

- Zabudovaná termostatická elektronická kontrolní jednotka (3-cestná).
- Sprchové kropítko z nerez. oceli s kaskádou 500x650 mm. 3 funkce (299.972.01).
- Držák s nástěnným přívodem vody (207.182.01).
- Ruční sprcha, proti usaz. vod. kamene (202.639.01).
- Flexi hadice SATIN (91.34.609.15).

DŮLEŽITÉ: Použijte odtokovou trubici pro průtok >50 l/min.



Cr | 092.863.02

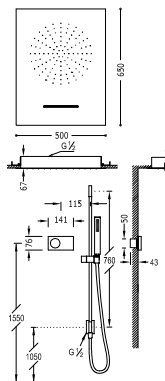

Kit elettronico per doccia termostatico da incasso SHOWER TECHNOLOGY

- Centralina termostatica elettronica inclusa (3 vie).
- Soffione doccia acciaio inossidabile con cascata 500x650 mm. 2 funzioni (299.970.01).
- Barra di scorrimento con presa d'acqua a parete. Lung. 760 mm (034.932.99).
- Doccetta anticalcare (202.639.01).
- Flessibile satin (91.34.609.15).

IMPORTANTE: Montare uno scarico di >50 l/min.

Built-in electronic thermostatic shower kit SHOWER TECHNOLOGY

- Electronic thermostatic control box included (3 ways).
- Stainless steel ceiling shower with cascade 500x650 mm. 3 positions (299.970.01).
- Sliding bar with wall water intake. Length: 760 mm. (034.932.99).
- Antilime hand shower (202.639.01).
- Shower hose SATIN (91.34.609.15).

IMPORTANT: Assemble a drain of >50 l/min.

Termostatický podomítkový elektronický sprchový set SHOWER TECHNOLOGY

- Zabudovaná termostatická elektronická kontrolní jednotka (3-cestná).
- Sprchové kropitko z nerez. oceli s kaskádou 500x650 mm. 2 funkce (299.970.01).
- Posuvná tyč s nástěnným přívodem vody. Délka 760 mm. (034.932.99).
- Ruční sprcha, proti usaz. vod. kamene (202.639.01).
- Flexi hadice SATIN (91.34.609.15).

DŮLEŽITÉ: Použijte odtokovou trubici pro průtok >50 l/min.



Cr 092.863.03

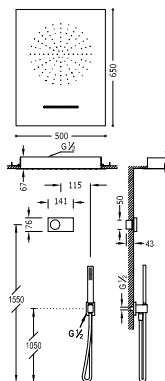

Kit elettronico per doccia termostatico da incasso SHOWER TECHNOLOGY

- Centralina termostatica elettronica inclusa (3 vie).
- Soffione doccia acciaio inossidabile con cascata 500x650 mm. 2 funzioni (299.970.01).
- Supporto per doccia (207.182.01).
- Doccetta anticalcare (202.639.01).
- Flessibile satin (91.34.609.15).

IMPORTANTE: Montare uno scarico di >50 l/min.

Built-in electronic thermostatic shower kit SHOWER TECHNOLOGY

- Electronic thermostatic control box included (3 ways).
- Stainless steel ceiling shower with cascade 500x650 mm. 3 positions (299.970.01).
- Elbow wall (207.182.01).
- Antilime hand shower (202.639.01).
- Shower hose SATIN (91.34.609.15).

IMPORTANT: Assemble a drain of >50 l/min.

Termostatický podomítkový elektronický sprchový set SHOWER TECHNOLOGY

- Zabudovaná termostatická elektronická kontrolní jednotka (3-cestná).
- Sprchové kropitko z nerez. oceli s kaskádou 500x650 mm. 2 funkce (299.970.01).
- Držák s nástěnným přívodem vody (207.182.01).
- Ruční sprcha, proti usaz. vod. kamene (202.639.01).
- Flexi hadice SATIN (91.34.609.15).

DŮLEŽITÉ: Použijte odtokovou trubici pro průtok >50 l/min.



Cr 092.863.04

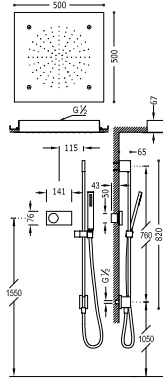

Kit elettronico per doccia termostatico da incasso
SHOWER TECHNOLOGY

- Centralina termostatica elettronica inclusa (3 vie).
- Soffione doccia acciaio inossidabile con cascata 500x500 mm. 2 funzioni (299.954.01).
- Barra di scorrimento con presa d'acqua a parete. Lung. 760 mm (034.932-99).
- Doccetta anticalcare (202.639.01).
- Flessibile satin (91.34.609.15).

IMPORTANTE: Montare uno scarico di >50 l/min.

Built-in electronic thermostatic shower kit
SHOWER TECHNOLOGY

- Electronic thermostatic control box included (3 ways).
- Stainless steel ceiling shower 500x500 mm. 2 positions (299.954.01).
- Sliding bar with wall water intake. Length: 760 mm. (034.932-99).
- Antilime hand shower (202.639.01).
- Shower hose SATIN (91.34.609.15).

IMPORTANT: Assemble a drain of >50 l/min.

Termostatický podomítkový elektronický sprchový set
SHOWER TECHNOLOGY

- Zabudovaná termostatická elektronická kontrolní jednotka (3-cestná).
- Sprchové kropítko z nerez. oceli 500x500 mm. 2 funkce (299.954.01).
- Posuvná tyč s nástěnným přívodem vody. Délka 760 mm. (034.932-99).
- Ruční sprcha, proti usaz. vod. kamene (202.639.01).
- Flexi hadice SATIN (91.34.609.15).

DŮLEŽITÉ: Použijte odtokovou trubici pro průtok >50 l/min.



Cr | 092.863.05

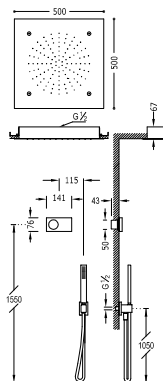

Kit elettronico per doccia termostatico da incasso
SHOWER TECHNOLOGY

- Centralina termostatica elettronica inclusa (3 vie).
- Soffione doccia acciaio inossidabile con cascata 500x500 mm. 2 funzioni (299.954.01).
- Supporto per doccia (207.182.01).
- Doccetta anticalcare (202.639.01).
- Flessibile satin (91.34.609.15).

IMPORTANTE: Montare uno scarico di >50 l/min.

Built-in electronic thermostatic shower kit
SHOWER TECHNOLOGY

- Electronic thermostatic control box included (3 ways).
- Stainless steel ceiling shower 500x500 mm. 2 positions (299.954.01).
- Elbow wall (207.182.01).
- Antilime hand shower (202.639.01).
- Shower hose SATIN (91.34.609.15).

IMPORTANT: Assemble a drain of >50 l/min.

Termostatický podomítkový elektronický sprchový set
SHOWER TECHNOLOGY

- Zabudovaná termostatická elektronická kontrolní jednotka (3-cestná).
- Sprchové kropítko z nerez. oceli 500x500 mm. 2 funkce (299.954.01).
- Držák s nástěnným přívodem vody (207.182.01).
- Ruční sprcha, proti usaz. vod. kamene (202.639.01).
- Flexi hadice SATIN (91.34.609.15).

DŮLEŽITÉ: Použijte odtokovou trubici pro průtok >50 l/min.



Cr | 092.863.06



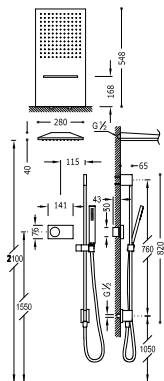

Kit elettronico per doccia termostatico da incasso
SHOWER TECHNOLOGY

- Centralina termostatica elettronica inclusa (3 vie).
- Doccia acciaio inossidabile da parete con cascata 280x550 mm. 2 funzioni (299.903.01).
- Barra di scorrimento con presa d'acqua a parete. Lung. 760 mm (034.932.99).
- Doccetta anticalcare (202.639.01).
- Flessibile satin (91.34.609.15).

IMPORTANTE: Montare uno scarico di >50 l/min.

Built-in electronic thermostatic shower kit
SHOWER TECHNOLOGY

- Electronic thermostatic control box included (3 ways).
- Stainless steel wall shower with cascade 280x550 mm. 2 positions (299.903.01).
- Sliding bar with wall water intake. Length: 760 mm. (034.932.99).
- Antilime hand shower (202.639.01).
- Shower hose SATIN (91.34.609.15).

IMPORTANT: Assemble a drain of >50 l/min.

Termostatický podomítkový elektronický sprchový set
SHOWER TECHNOLOGY

- Zabudovaná termostatická elektronická kontrolní jednotka (3-cestná).
- Sprchové kropitko z nerez. oceli s kaskádou 280x550 mm. 2 funkce (299.903.01).
- Posuvná tyč s nástěnným přívodem vody. Délka 760 mm. (034.932.99).
- Ruční sprcha, proti usaz. vod. kamene (202.639.01).
- FLEXI hadice SATIN (91.34.609.15).

DŮLEŽITÉ: Použijte odtokovou trubici pro průtok >50 l/min.



Cr 092.863.07

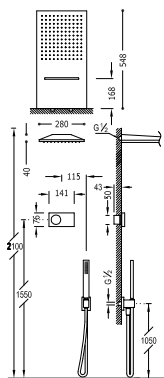

Kit elettronico per doccia termostatico da incasso
SHOWER TECHNOLOGY

- Centralina termostatica elettronica inclusa (3 vie).
- Doccia acciaio inossidabile da parete con cascata 280x550 mm. 2 funzioni (299.903.01).
- Supporto per doccia (207.182.01).
- Doccetta anticalcare (202.639.01).
- Flessibile satin (91.34.609.15).

IMPORTANTE: Montare uno scarico di >50 l/min.

Built-in electronic thermostatic shower kit
SHOWER TECHNOLOGY

- Electronic thermostatic control box included (3 ways).
- Stainless steel wall shower with cascade 280x550 mm. 2 positions (299.903.01).
- Elbow wall (207.182.01).
- Antilime hand shower (202.639.01).
- Shower hose SATIN (91.34.609.15).

IMPORTANT: Assemble a drain of >50 l/min.

Termostatický podomítkový elektronický sprchový set
SHOWER TECHNOLOGY

- Zabudovaná termostatická elektronická kontrolní jednotka (3-cestná).
- Sprchové kropitko z nerez. oceli s kaskádou 500x650 mm. 2 funkce (299.903.01).
- Držák s nástěnným přívodem vody (207.182.01).
- Ruční sprcha, proti usaz. vod. kamene (202.639.01).
- FLEXI hadice SATIN (91.34.609.15).

DŮLEŽITÉ: Použijte odtokovou trubici pro průtok >50 l/min.



Cr 092.863.08

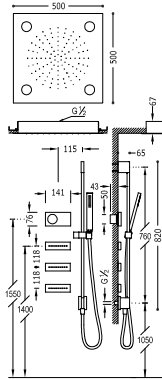

Kit elettronico per doccia termostatico da incasso
SHOWER TECHNOLOGY CHROMOTHERAPY

- Centralina termostatica elettronica inclusa (3 vie).
- Soffione doccia acciaio inossidabile con cascata 500x500 mm. 2 funzioni (299.962.01).
- 3 jets anticalcare (299.515.04).
- Barra di scorrimento con presa d'acqua a parete. Lung. 760 mm (034.932.99).
- Doccetta anticalcare (202.639.01).
- Flessibile satin (91.34.609.15).

IMPORTANTE: Montare uno scarico di >50 l/min.

Built-in electronic thermostatic shower kit
SHOWER TECHNOLOGY CHROMOTHERAPY

- Electronic thermostatic control box included (3 ways).
- Stainless steel ceiling shower 500x500 mm. 2 positions (299.962.01).
- 3 antilime jets (299.515.04).
- Sliding bar with wall water intake. Length: 760 mm. (034.932.99).
- Antilime hand shower (202.639.01).
- Shower hose SATIN (91.34.609.15).

IMPORTANT: Assemble a drain of >50 l/min.

Termostatický podomítkový elektronický sprchový set
SHOWER TECHNOLOGY CHROMOTHERAPY

- Zabudovaná termostatická elektronická kontrolní jednotka (3-cestná).
- Sprchové křepitko z nerez. oceli 500x500 mm. 2 funkce (299.962.01).
- 3 natáčecí trysky, proti usaz. vod. kamene. (299.515.04).
- Posuvná tyč s nástěnným přívodem vody. Délka 760 mm. (034.932.99).
- Ruční sprcha, proti usaz. vod. kamene (202.639.01).
- Flexi hadice SATIN (91.34.609.15).

DŮLEŽITÉ: Použijte odtokovou trubici pro průtok >50 l/min.



Cr | 092.863.09

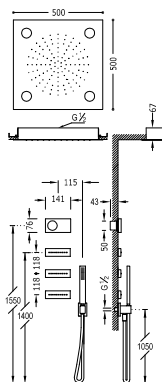

Kit elettronico per doccia termostatico da incasso
SHOWER TECHNOLOGY CHROMOTHERAPY

- Centralina termostatica elettronica inclusa (3 vie).
- Soffione doccia acciaio inossidabile con cascata 500x500 mm. 2 funzioni (299.962.01).
- 3 jets anticalcare (299.515.04).
- Supporto per doccia (207.182.01).
- Doccetta anticalcare (202.639.01).
- Flessibile satin (91.34.609.15).

IMPORTANTE: Montare uno scarico di >50 l/min.

Built-in electronic thermostatic shower kit
SHOWER TECHNOLOGY CHROMOTHERAPY

- Electronic thermostatic control box included (3 ways).
- Stainless steel ceiling shower 500x500 mm. 2 positions (299.962.01).
- 3 antilime jets (299.515.04).
- Elbow wall (207.182.01).
- Antilime hand shower (202.639.01).
- Shower hose SATIN (91.34.609.15).

IMPORTANT: Assemble a drain of >50 l/min.

Termostatický podomítkový elektronický sprchový set
SHOWER TECHNOLOGY CHROMOTHERAPY

- Zabudovaná termostatická elektronická kontrolní jednotka (3-cestná).
- Sprchové křepitko z nerez. oceli 500x500 mm. 2 funkce (299.962.01).
- 3 natáčecí trysky, proti usaz. vod. kamene. (299.515.04).
- Držák s nástěnným přívodem vody (207.182.01).
- Ruční sprcha, proti usaz. vod. kamene (202.639.01).
- Flexi hadice SATIN (91.34.609.15).

DŮLEŽITÉ: Použijte odtokovou trubici pro průtok >50 l/min.



Cr | 092.863.10

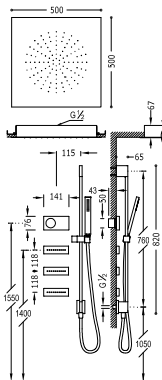

Kit elettronico per doccia termostatico da incasso
SHOWER TECHNOLOGY

- Centralina termostatica elettronica inclusa (3 vie).
- Soffione doccia acciaio inossidabile 500x500 mm. (299.953.02).
- 3 jets anticalcare (299.515.04).
- Barra di scorrimento con presa d'acqua a parete. Lung. 760 mm (034.932.99).
- Doccetta anticalcare (202.639.01).
- Flessibile satin (91.34.609.15).

IMPORTANTE: Montare uno scarico di >50 l/min.

**Built-in electronic thermostatic shower kit
SHOWER TECHNOLOGY**

- Electronic thermostatic control box included (3 ways).
- Stainless steel ceiling shower 500x500 mm. (299.953.02).
- 3 antilime jets (299.515.04).
- Sliding bar with wall water intake. Length: 760 mm. (034.932.99).
- Antilime hand shower (202.639.01).
- Shower hose SATIN (91.34.609.15).

IMPORTANT: Assemble a drain of >50 l/min.

Termostatický podomítkový elektronický sprchový set
SHOWER TECHNOLOGY

- Zabudovaná termostatická elektronická kontrolní jednotka (3-cestná).
- Sprchové kropítko z nerez. oceli 500x500 mm. 2 funkce (299.953.02).
- 3 natáčecí trysky, proti usaz. vod. kamene. (299.515.04).
- Posuvná tyč s nástěnným přívodem vody. Délka 760 mm. (034.932.99).
- Ruční sprcha, proti usaz. vod. kamene (202.639.01).
- Flexi hadice SATIN (91.34.609.15).

DŮLEŽITÉ: Použijte odtokovou trubici pro průtok >50 l/min.



Cr 092.863.11

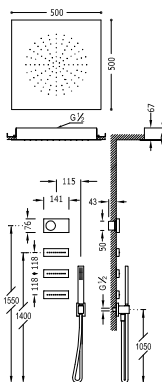

Kit elettronico per doccia termostatico da incasso
SHOWER TECHNOLOGY

- Centralina termostatica elettronica inclusa (3 vie).
- Soffione doccia acciaio inossidabile 500x500 mm. (299.953.02).
- 3 jets anticalcare (299.515.04).
- Supporto per doccia (207.182.01).
- Doccetta anticalcare (202.639.01).
- Flessibile satin (91.34.609.15).

IMPORTANTE: Montare uno scarico di >50 l/min.

**Built-in electronic thermostatic shower kit
SHOWER TECHNOLOGY**

- Electronic thermostatic control box included (3 ways).
- Stainless steel ceiling shower 500x500 mm. (299.953.02).
- 3 antilime jets (299.515.04).
- Elbow wall (207.182.01).
- Antilime hand shower (202.639.01).
- Shower hose SATIN (91.34.609.15).

IMPORTANT: Assemble a drain of >50 l/min.

Termostatický podomítkový elektronický sprchový set
SHOWER TECHNOLOGY

- Zabudovaná termostatická elektronická kontrolní jednotka (3-cestná).
- Sprchové kropítko z nerez. oceli 500x500 mm. 2 funkce (299.953.02).
- 3 natáčecí trysky, proti usaz. vod. kamene. (299.515.04).
- Držák s nástěnným přívodem vody (207.182.01).
- Ruční sprcha, proti usaz. vod. kamene (202.639.01).
- Flexi hadice SATIN (91.34.609.15).

DŮLEŽITÉ: Použijte odtokovou trubici pro průtok >50 l/min.



Cr 092.863.12

N

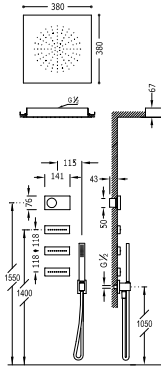

Kit elettronico per doccia termostatico da incasso
SHOWER TECHNOLOGY

- Centralina termostatica elettronica inclusa (3 vie).
 - Soffione doccia acciaio inossidabile 380x380 mm. (299.953.01).
 - 3 jets anticalcare (299.515.04).
 - Supporto per doccia (207.182.01).
 - Doccetta anticalcare (202.639.01).
 - Flessibile satin (91.34.609.15).
- IMPORTANTE: Montare uno scarico di >50 l/min.

Built-in electronic thermostatic shower kit
SHOWER TECHNOLOGY

- Electronic thermostatic control box included (3 ways).
 - Stainless steel ceiling shower 380x380 mm. (299.953.01).
 - 3 antilime jets (299.515.04).
 - Elbow wall (207.182.01).
 - Antilime hand shower (202.639.01).
 - Shower hose SATIN (91.34.609.15).
- IMPORTANT: Assemble a drain of >50 l/min.

Termostatický podomítkový elektronický sprchový set
SHOWER TECHNOLOGY

- Zabudovaná termostatická elektronická kontrolní jednotka (3-cestná).
 - Sprchové kropítko z nerez. oceli 380x380 mm. (299.953.01).
 - 3 natáče trysky, proti usaz. vod. kamene. (299.515.04).
 - Držák s nástěnným přívodem vody (207.182.01).
 - Ruční sprcha, proti usaz. vod. kamene (202.639.01).
 - Flexi hadice SATIN (91.34.609.15).
- DŮLEŽITÉ: Použijte odtokovou trubici pro průtok >50 l/min.

N

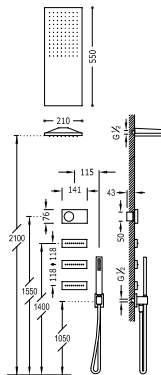

Kit elettronico per doccia termostatico da incasso
SHOWER TECHNOLOGY

- Centralina termostatica elettronica inclusa (3 vie).
 - Doccia acciaio inossidabile da parete 210x550 mm. (299.903.02).
 - 3 jets anticalcare (299.515.04).
 - Supporto per doccia (207.182.01).
 - Doccetta anticalcare (202.639.01).
 - Flessibile satin (91.34.609.15).
- IMPORTANTE: Montare uno scarico di >50 l/min.

Built-in electronic thermostatic shower kit
SHOWER TECHNOLOGY

- Electronic thermostatic control box included (3 ways).
 - Stainless steel wall shower 210x550 mm. (299.903.02).
 - 3 antilime jets (299.515.04).
 - Elbow wall (207.182.01).
 - Antilime hand shower (202.639.01).
 - Shower hose SATIN (91.34.609.15).
- IMPORTANT: Assemble a drain of >50 l/min.

Termostatický podomítkový elektronický sprchový set
SHOWER TECHNOLOGY

- Zabudovaná termostatická elektronická kontrolní jednotka (3-cestná).
 - Nástěnné sprchové kropítko z nerez. oceli 210x550 mm. (299.903.02).
 - 3 natáče trysky, proti usaz. vod. kamene. (299.515.04).
 - Držák s nástěnným přívodem vody (207.182.01).
 - Ruční sprcha, proti usaz. vod. kamene (202.639.01).
 - Flexi hadice SATIN (91.34.609.15).
- DŮLEŽITÉ: Použijte odtokovou trubici pro průtok >50 l/min.



Cr | 092.863.13



Cr | 092.863.14

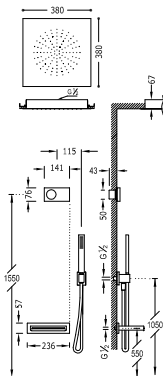

Kit elettronico per vasca da bagno termostatico da incasso
SHOWER TECHNOLOGY

- Centralina termostatica elettronica inclusa (3 vie).
- Soffione doccia acciaio inossidabile 380x380 mm. (299.953.01).
- Tubo cascata vasca acciaio inossidabile (299.903.04).
- Supporto per doccia (207.182.01).
- Doccetta anticalcare (202.639.01).
- Flessibile satin (91.34.609.15).

IMPORTANTE: Montare uno scarico di >50 l/min.

Built-in electronic thermostatic bath kit
SHOWER TECHNOLOGY

- Electronic thermostatic control box included (3 ways).
- Stainless steel ceiling shower 380x380 mm. (299.953.01).
- Steel cascade cast spout (299.903.04).
- Elbow wall (207.182.01).
- Antilime hand shower (202.639.01).
- Shower hose SATIN (91.34.609.15).

IMPORTANT: Assemble a drain of >50 l/min.

Termostatický podomítkový elektronický vanový set
SHOWER TECHNOLOGY

- Zabudovaná termostatická elektronická kontrolní jednotka (3-cestná).
- Sprchové kropítko z nerez. oceli 380x380 mm. (299.953.01).
- Vanové ramínko s kaskádou z nerez. oceli. (299.903.04).
- Držák s nástěnným přívodem vody (207.182.01).
- Ruční sprcha, proti usaz. vod. kamene (202.639.01).
- Flexi hadice SATIN (91.34.609.15).

DŮLEŽITÉ: Použijte odtokovou trubici pro průtok >50 l/min.



Cr 092.863.15

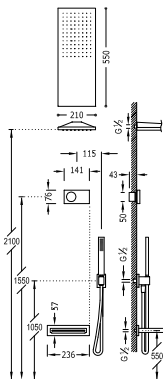

Kit elettronico per vasca da bagno termostatico da incasso
SHOWER TECHNOLOGY

- Centralina termostatica elettronica inclusa (3 vie).
- Doccia acciaio inossidabile da parete 210x550 mm. (299.903.02).
- Tubo cascata vasca acciaio inossidabile (299.903.04).
- Supporto per doccia (207.182.01).
- Doccetta anticalcare (202.639.01).
- Flessibile satin (91.34.609.15).

IMPORTANTE: Montare uno scarico di >50 l/min.

Built-in electronic thermostatic bath kit
SHOWER TECHNOLOGY

- Electronic thermostatic control box included (3 ways).
- Stainless steel wall shower 210x550 mm. (299.903.02).
- Steel cascade cast spout (299.903.04).
- Elbow wall (207.182.01).
- Antilime hand shower (202.639.01).
- Shower hose SATIN (91.34.609.15).

IMPORTANT: Assemble a drain of >50 l/min.

Termostatický podomítkový elektronický vanový set
SHOWER TECHNOLOGY

- Zabudovaná termostatická elektronická kontrolní jednotka (3-cestná).
- Nástěnné sprchové kropítko z nerez. oceli 210x550 mm. (299.903.02).
- Vanové ramínko s kaskádou z nerez. oceli. (299.903.04).
- Držák s nástěnným přívodem vody (207.182.01).
- Ruční sprcha, proti usaz. vod. kamene (202.639.01).
- Flexi hadice SATIN (91.34.609.15).

DŮLEŽITÉ: Použijte odtokovou trubici pro průtok >50 l/min.



Cr 092.863.16

N

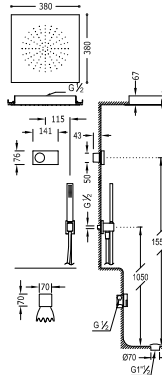

Kit elettronico per vasca da bagno termostatico da incasso
SHOWER TECHNOLOGY

- Centralina termostatica elettronica inclusa (3 vie).
- Soffione doccia acciaio inossidabile 380x380 mm. (299.953.01).
- Scarico vasca e valvola di riempimento rotonda A CASCATA con troppopieno (1.34.534.30).
- Sifone PVC vasca (1.34.634.60).
- Supporto per doccia (207.182.01).
- Doccetta anticalcare (202.639.01).
- Flessibile satin (91.34.609.15).

Built-in electronic thermostatic bath kit
SHOWER TECHNOLOGY

- Electronic thermostatic control box included (3 ways).
- Stainless steel ceiling shower 380x380 mm. (299.953.01).
- Bath drain and round CASCADE filling valve with overflow drain. (1.34.534.30).
- Bath PVC drain trap (1.34.634.60).
- Elbow wall (207.182.01).
- Antilime hand shower (202.639.01).
- Shower hose SATIN (91.34.609.15).

Termostatický podomítkový elektronický vanový set
SHOWER TECHNOLOGY

- Zabudovaná termostatická elektronická kontrolní jednotka (3-cestná).
- Sprchové kropítko z nerez. oceli 380x380 mm. (299.953.01).
- Odtoková a napouštěcí vanová kulatá KASKÁDA s přepadem (1.34.534.40).
- Vanový sifon z PVC (1.34.634.60).
- Držák s nástěnným přívodem vody (207.182.01).
- Ruční sprcha, proti usaz. vod. kamene (202.639.01).
- Flexi hadice SATIN (91.34.609.15).



Cr | 092.863.17

SHOWER
TECH.



N

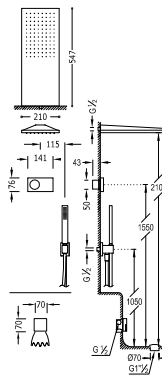

Kit elettronico per vasca da bagno termostatico da incasso
SHOWER TECHNOLOGY

- Centralina termostatica elettronica inclusa (3 vie).
- Doccia acciaio inossidabile da parete 210x550 mm. (299.903.02).
- Scarico vasca e valvola di riempimento rotonda A CASCATA con troppopieno (1.34.534.30).
- Sifone PVC vasca (1.34.634.60).
- Supporto per doccia (207.182.01).
- Doccetta anticalcare (202.639.01).
- Flessibile satin (91.34.609.15).

Built-in electronic thermostatic bath kit
SHOWER TECHNOLOGY

- Electronic thermostatic control box included (3 ways).
- Stainless steel wall shower 210x550 mm. (299.903.02).
- Bath drain and round CASCADE filling valve with overflow drain. (1.34.534.30).
- Bath PVC drain trap (1.34.634.60).
- Elbow wall (207.182.01).
- Antilime hand shower (202.639.01).
- Shower hose SATIN (91.34.609.15).

Termostatický podomítkový elektronický vanový set
SHOWER TECHNOLOGY

- Zabudovaná termostatická elektronická kontrolní jednotka (3-cestná).
- Nástěnné sprchové kropítko z nerez. oceli 380x380 mm. (299.903.02).
- Odtoková a napouštěcí vanová kulatá KASKÁDA s přepadem (1.34.534.40).
- Vanový sifon z PVC (1.34.634.60).
- Držák s nástěnným přívodem vody (207.182.01).
- Ruční sprcha, proti usaz. vod. kamene (202.639.01).
- Flexi hadice SATIN (91.34.609.15).



Cr | 092.863.18

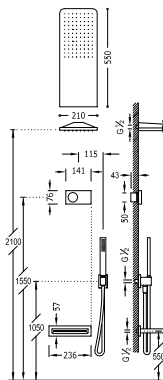

Kit elettronico per vasca da bagno termostatico da incasso
SHOWER TECHNOLOGY

- Centralina termostatica elettronica inclusa (3 vie).
- Doccia acciaio inossidabile da parete 210x550 mm. (299.903.07).
- Tubo cascata vasca acciaio inossidabile (299.903.04).
- Supporto per doccia (207.182.01).
- Doccetta anticalcare (202.639.01).
- Flessibile satin (91.34.609.15).

IMPORTANTE: Montare uno scarico di >50 l/min.

Built-in electronic thermostatic bath kit
SHOWER TECHNOLOGY

- Electronic thermostatic control box included (3 ways).
- Stainless steel wall shower 210x550 mm. (299.903.07).
- Steel cascade cast spout (299.903.04).
- Elbow wall (207.182.01).
- Antilime hand shower (202.639.01).
- Shower hose SATIN (91.34.609.15).

IMPORTANT: Assemble a drain of >50 l/min.

Termostatický podomítkový elektronický vanový set
SHOWER TECHNOLOGY

- Zabudovaná termostatická elektronická kontrolní jednotka (3-cestná).
- Nástěnné sprchové křepitko z nerez. oceli 210x550 mm. (299.903.07).
- Vanové ramínko s kaskádou z nerez. oceli (299.903.04).
- Držák s nástěnným přívodem vody (207.182.01).
- Ruční sprcha, proti usaz. vod. kamene (202.639.01).
- Flexi hadice SATIN (91.34.609.15).

DŮLEŽITÉ: Použijte odtokovou trubici pro průtok >50 l/min.



Cr 092.863.19

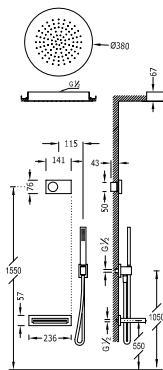

Kit elettronico per vasca da bagno termostatico da incasso
SHOWER TECHNOLOGY

- Centralina termostatica elettronica inclusa (3 vie).
- Soffione doccia acciaio inossidabile Ø 380 mm. (1.34.940).
- Tubo cascata vasca acciaio inossidabile (299.903.04).
- Supporto per doccia (207.182.01).
- Doccetta anticalcare (034.116.01).
- Flessibile satin (91.34.609.15).

IMPORTANTE: Montare uno scarico di >50 l/min.

Built-in electronic thermostatic bath kit
SHOWER TECHNOLOGY

- Electronic thermostatic control box included (3 ways).
- Stainless steel ceiling shower Ø 380 mm. (1.34.940).
- Steel cascade cast spout (299.903.04).
- Elbow wall (207.182.01).
- Antilime hand shower (034.116.01).
- Shower hose SATIN (91.34.609.15).

IMPORTANT: Assemble a drain of >50 l/min.

Termostatický podomítkový elektronický vanový set
SHOWER TECHNOLOGY

- Zabudovaná termostatická elektronická kontrolní jednotka (3-cestná).
- Sprchové křepitko z nerez. oceli Ø 380 mm. (1.34.940).
- Vanové ramínko s kaskádou z nerez. oceli (299.903.04).
- Držák s nástěnným přívodem vody (207.182.01).
- Ruční sprcha, proti usaz. vod. kamene (034.116.01).
- Flexi hadice SATIN (91.34.609.15).

DŮLEŽITÉ: Použijte odtokovou trubici pro průtok >50 l/min.



Cr 092.863.20

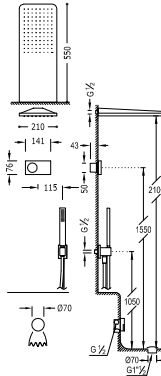

Kit elettronico per vasca da bagno termostatico da incasso
SHOWER TECHNOLOGY

- Centralina termostatica elettronica inclusa (3 vie).
- Doccia acciaio inossidabile da parete 210x550 mm. (299.903.07).
- Scarico vasca e valvola di riempimento rotonda A CASCATA con troppopieno (1.34.534.30).
- Sifone PVC vasca (1.34.634.60).
- Supporto per doccia (207.182.01).
- Doccetta anticalcare (202.639.01).
- Flessibile satin (91.34.609.15).

Built-in electronic thermostatic bath kit
SHOWER TECHNOLOGY

- Electronic thermostatic control box included (3 ways).
- Stainless steel wall shower 210x550 mm. (299.903.07).
- Bath drain and round CASCADE filling valve with overflow drain. (1.34.534.30).
- Bath PVC drain trap (1.34.634.60).
- Elbow wall (207.182.01).
- Antilime hand shower (202.639.01).
- Shower hose SATIN (91.34.609.15).

Termostatický podomítkový elektronický vanový set
SHOWER TECHNOLOGY

- Zabudovaná termostatická elektronická kontrolní jednotka (3-cestná).
- Nástěnné sprchové křepitko z nerez. oceli 210x550 mm. (299.903.07).
- Odtoková a napouštěcí vanová kulatá KASKÁDA s přepadem (1.34.534.30).
- Vanový sifon z PVC (1.34.634.60).
- Držák s nástěnným přívodem vody (207.182.01).
- Ruční sprcha, proti usaz. vod. kamene (202.639.01).
- Flexi hadice SATIN (91.34.609.15).



Cr | 092.863.21 |

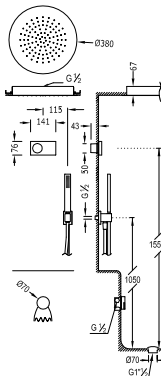

Kit elettronico per vasca da bagno termostatico da incasso
SHOWER TECHNOLOGY

- Centralina termostatica elettronica inclusa (3 vie).
- Soffione doccia acciaio inossidabile Ø 380 mm. (1.34.940).
- Scarico vasca e valvola di riempimento rotonda A CASCATA con troppopieno (1.34.534.30).
- Sifone PVC vasca (1.34.634.60).
- Supporto per doccia (207.182.01).
- Doccetta anticalcare (034.116.01).
- Flessibile satin (91.34.609.15).

Built-in electronic thermostatic bath kit
SHOWER TECHNOLOGY

- Electronic thermostatic control box included (3 ways).
- Stainless steel ceiling shower Ø 380 mm. (1.34.940).
- Bath drain and round CASCADE filling valve with overflow drain. (1.34.534.30).
- Bath PVC drain trap (1.34.634.60).
- Elbow wall (207.182.01).
- Antilime hand shower (034.116.01).
- Shower hose SATIN (91.34.609.15).

Termostatický podomítkový elektronický vanový set
SHOWER TECHNOLOGY

- Zabudovaná termostatická elektronická kontrolní jednotka (3-cestná).
- Sprchové křepitko z nerez. oceli Ø 380 mm. (1.34.940).
- Odtoková a napouštěcí vanová kulatá KASKÁDA s přepadem (1.34.534.30).
- Vanový sifon z PVC (1.34.634.60).
- Držák s nástěnným přívodem vody (207.182.01).
- Ruční sprcha, proti usaz. vod. kamene (034.116.01).
- Flexi hadice SATIN (91.34.609.15).



Cr | 092.863.22 |

4 VIE / WAYS / CESTNÁ

Ref. /Nr./ Kód:

N

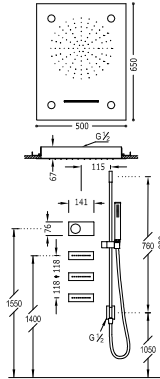

Kit elettronico per doccia termostatico da incasso
SHOWER TECHNOLOGY CHROMOTHERAPY

- Centralina termostatica elettronica inclusa (3 vie).
- Soffione doccia acciaio inossidabile con cascata 500x650 mm.
- 3 funzioni (299.972.01).
- 3 jets anticalcare (299.515.04).
- Barra di scorrimento con presa d'acqua a parete. Lung. 760 mm (034.932.99).
- Doccetta anticalcare (202.639.01).
- Flessibile satin (91.34.609.15).

**Built-in electronic thermostatic shower kit
SHOWER TECHNOLOGY CHROMOTHERAPY**

- Electronic thermostatic control box included (4 ways).
- Stainless steel ceiling shower with cascade 500x650 mm.
- 3 positions (299.972.01).
- 3 antilime jets (299.515.04).
- Sliding bar with wall water intake. Length: 760 mm. (034.932.99).
- Antilime hand shower (202.639.01).
- Shower hose SATIN (91.34.609.15).

**Termostatický podomítkový elektronický sprchový set
SHOWER TECHNOLOGY CHROMOTHERAPY**

- Zabudovaná termostatická elektronická kontrolní jednotka (4-cestná).
- Sprchové křepitko z nerez. oceli s kaskádou 500x650 mm.
- 3 funkce (299.972.01).
- 3 natáčecí trysky, proti usaz. vod. Kamene. (299.515.04).
- Posuvná tyč s nástěnným přívodem vody. Délka 760 mm. (034.932.99).
- Ruční sprcha, proti usaz. vod. kamene (202.639.01).
- Flexi hadice SATIN (91.34.609.15).

DŮLEŽITÉ: Použijte odtokovou trubici pro průtok >50 l/min.



Cr 092.864.01

N

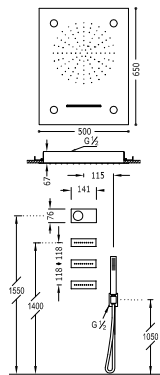

Kit elettronico per doccia termostatico da incasso
SHOWER TECHNOLOGY CHROMOTHERAPY

- Centralina termostatica elettronica inclusa (3 vie).
- Doccia acciaio inossidabile da parete con cascata 500x650 mm.
- 3 funzioni (299.972.01).
- 3 jets anticalcare (299.515.04).
- Supporto per doccia (207.182.01).
- Doccetta anticalcare (202.639.01).
- Flessibile satin (91.34.609.15).

**Built-in electronic thermostatic shower kit
SHOWER TECHNOLOGY CHROMOTHERAPY**

- Electronic thermostatic control box included (4 ways).
- Stainless steel ceiling shower with cascade 500x650 mm.
- 3 positions (299.972.01).
- 3 antilime jets (299.515.04).
- Elbow wall (207.182.01).
- Antilime hand shower (202.639.01).
- Shower hose SATIN (91.34.609.15).

**Termostatický podomítkový elektronický sprchový set
SHOWER TECHNOLOGY CHROMOTHERAPY**

- Zabudovaná termostatická elektronická kontrolní jednotka (3-cestná).
- Sprchové křepitko z nerez. oceli s kaskádou 500x650 mm.
- 2 funkce (299.903.01).
- 3 natáčecí trysky, proti usaz. vod. Kamene. (299.515.04).
- Držák s nástěnným přívodem vody (207.182.01).
- Ruční sprcha, proti usaz. vod. kamene (202.639.01).
- Flexi hadice SATIN (91.34.609.15).

DŮLEŽITÉ: Použijte odtokovou trubici pro průtok >50 l/min.



Cr 092.864.02

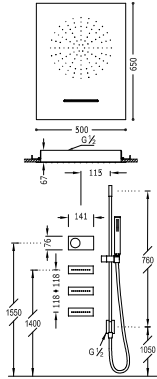

Kit elettronico per doccia termostatico da incasso
SHOWER TECHNOLOGY

- Centralina termostatica elettronica inclusa (3 vie).
- Soffione doccia acciaio inossidabile con cascata 500x650 mm. 2 funzioni (299.970.01).
- 3 jets anticalcare (299.515.04).
- Barra di scorrimento con presa d'acqua a parete. Lung. 760 mm (034.932.99).
- Doccetta anticalcare (202.639.01).
- Flessibile satin (91.34.609.15).

Built-in electronic thermostatic shower kit
SHOWER TECHNOLOGY

- Electronic thermostatic control box included (4 ways).
- Stainless steel ceiling shower with cascade 500x650 mm. 2 positions (299.970.01).
- 3 antilime jets (299.515.04).
- Sliding bar with wall water intake. Length: 760 mm. (034.932.99).
- Antilime hand shower (202.639.01).
- Shower hose SATIN (91.34.609.15).

Termostatický podomítkový elektronický sprchový set
SHOWER TECHNOLOGY

- Zabudovaná termostatická elektronická kontrolní jednotka (4-cestná).
- Sprchové kropítko z nerez. oceli s kaskádou 500x650 mm. 2 funkce (299.970.01).
- 3 natáčecí trysky, proti usaz. vod. Kamene. (299.515.04).
- Posuvná tyč s nástěnným přívodem vody. Délka 760 mm. (034.932.99).
- Ruční sprcha, proti usaz. vod. kamene (202.639.01).
- Flexi hadice SATIN (91.34.609.15).

DŮLEŽITÉ: Použijte odtokovou trubici pro průtok >50 l/min.



Cr | 092.864.03

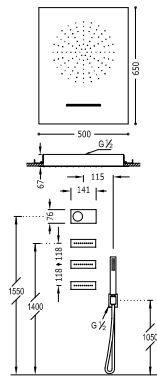

Kit elettronico per doccia termostatico da incasso
SHOWER TECHNOLOGY

- Centralina termostatica elettronica inclusa (3 vie).
- Doccia acciaio inossidabile da parete con cascata 500x650 mm. 2 funzioni (299.970.01).
- 3 jets anticalcare (299.515.04).
- Supporto per doccia (207.182.01).
- Doccetta anticalcare (202.639.01).
- Flessibile satin (91.34.609.15).

Built-in electronic thermostatic shower kit
SHOWER TECHNOLOGY

- Electronic thermostatic control box included (4 ways).
- Stainless steel ceiling shower with cascade 500x650 mm. 2 positions (299.970.01).
- 3 antilime jets (299.515.04).
- Elbow wall (207.182.01).
- Antilime hand shower (202.639.01).
- Shower hose SATIN (91.34.609.15).

Termostatický podomítkový elektronický sprchový set
SHOWER TECHNOLOGY

- Zabudovaná termostatická elektronická kontrolní jednotka (4-cestná).
- Sprchové kropítko z nerez. oceli s kaskádou 500x650 mm. 2 funkce (299.970.01).
- 3 natáčecí trysky, proti usaz. vod. Kamene. (299.515.04).
- Držák s nástěnným přívodem vody (207.182.01).
- Ruční sprcha, proti usaz. vod. kamene (202.639.01).
- Flexi hadice SATIN (91.34.609.15).

DŮLEŽITÉ: Použijte odtokovou trubici pro průtok >50 l/min.



Cr | 092.864.04

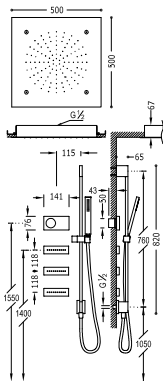

Kit elettronico per doccia termostatico da incasso
SHOWER TECHNOLOGY

- Centralina termostatica elettronica inclusa (3 vie).
- Soffione doccia acciaio inossidabile 500x500 mm. 2 funzioni (299.954.01).
- 3 jets anticalcare (299.515.04).
- Barra di scorrimento con presa d'acqua a parete. Lung. 760 mm (034.932.99).
- Doccetta anticalcare (202.639.01).
- Flessibile satin (91.34.609.15).

IMPORTANTE: Montare uno scarico di >50 l/min.

Built-in electronic thermostatic shower kit
SHOWER TECHNOLOGY

- Electronic thermostatic control box included (4 ways).
- Stainless steel ceiling shower 500x500 mm. 2 positions (299.954.01).
- 3 antilime jets (299.515.04).
- Sliding bar with wall water intake. Length: 760 mm. (034.932.99).
- Antilime hand shower (202.639.01).
- Shower hose SATIN (91.34.609.15).

IMPORTANTE: Assemble a drain of >50 l/min.

Termostatický podomítkový elektronický sprchový set
SHOWER TECHNOLOGY

- Zabudovaná termostatická elektronická kontrolní jednotka (3-cestná).
- Sprchové kropitko z nerez. oceli 500x500 mm. 2 funkce (299.954.01).
- 3 natáčecí trysky, proti usaz. vod. kamene. (299.515.04).
- Posuvná tyč s nástěnným přívodem vody. Délka 760 mm. (034.932.99).
- Ruční sprcha, proti usaz. vod. kamene (202.639.01).
- Flexi hadice SATIN (91.34.609.15).

DŮLEŽITÉ: Použijte odtokovou trubici pro průtok >50 l/min.



Cr 092.864.05

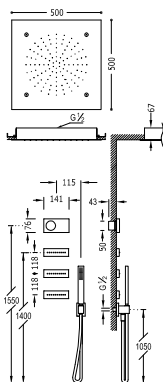

Kit elettronico per doccia termostatico da incasso
SHOWER TECHNOLOGY

- Centralina termostatica elettronica inclusa (3 vie).
- Soffione doccia acciaio inossidabile 500x500 mm. 2 funzioni (299.954.01).
- 3 jets anticalcare (299.515.04).
- Supporto per doccia (207.182.01).
- Doccetta anticalcare (202.639.01).
- Flessibile satin (91.34.609.15).

IMPORTANTE: Montare uno scarico di >50 l/min.

Built-in electronic thermostatic shower kit
SHOWER TECHNOLOGY

- Electronic thermostatic control box included (4 ways).
- Stainless steel ceiling shower 500x500 mm. 2 positions (299.954.01).
- 3 antilime jets (299.515.04).
- Elbow wall (207.182.01).
- Antilime hand shower (202.639.01).
- Shower hose SATIN (91.34.609.15).

IMPORTANT: Assemble a drain of >50 l/min.

Termostatický podomítkový elektronický sprchový set
SHOWER TECHNOLOGY

- Zabudovaná termostatická elektronická kontrolní jednotka (3-cestná).
- Sprchové kropitko z nerez. oceli 500x500 mm. 2 funkce (299.954.01).
- 3 natáčecí trysky, proti usaz. vod. kamene. (299.515.04).
- Držák s nástěnným přívodem vody (207.182.01).
- Ruční sprcha, proti usaz. vod. kamene (202.639.01).
- Flexi hadice SATIN (91.34.609.15).

DŮLEŽITÉ: Použijte odtokovou trubici pro průtok >50 l/min.



Cr 092.864.06

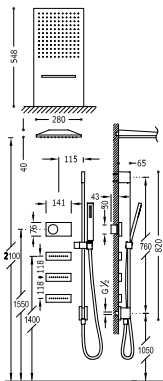

Kit elettronico per doccia termostatico da incasso
SHOWER TECHNOLOGY

- Centralina termostatica elettronica inclusa (3 vie).
- Soffione doccia acciaio inossidabile con cascata 280x550 mm. 2 funzioni (299.903.01).
- 3 jets anticalcare (299.515.04).
- Barra di scorrimento con presa d'acqua a parete. Lung. 760 mm (034.932.99).
- Doccetta anticalcare (202.639.01).
- Flessibile satin (91.34.609.15).

IMPORTANTE: Montare uno scarico di >50 l/min.

Built-in electronic thermostatic shower kit
SHOWER TECHNOLOGY

- Electronic thermostatic control box included (4 ways).
- Stainless steel ceiling shower with cascade 280x550 mm. 2 positions (299.903.01).
- 3 antilime jets (299.515.04).
- Sliding bar with wall water intake. Length: 760 mm. (034.932.99).
- Antilime hand shower (202.639.01).
- Shower hose SATIN (91.34.609.15).

IMPORTANT: Assemble a drain of >50 l/min.

Termostatický podomítkový elektronický sprchový set
SHOWER TECHNOLOGY

- Zabudovaná termostatická elektronická kontrolní jednotka (4-cestná).
- Sprchové křepátko z nerez. oceli s kaskádou 280x550 mm. 2 funkce (299.903.01).
- 3 natáčecí trysky, proti usaz. vod. Kamene. (299.515.04).
- Posuvná tyč s nástěnným přívodem vody. Délka 760 mm. (034.932.99).
- Ruční sprcha, proti usaz. vod. kamene (202.639.01).
- Flexi hadice SATIN (91.34.609.15).

DŮLEŽITÉ: Použijte odtokovou trubici pro průtok >50 l/min.



Cr | **092.864.07**

SHOWER
TECH.

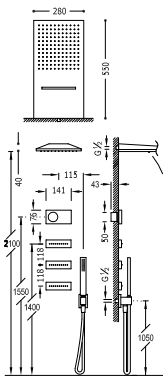

Kit elettronico per doccia termostatico da incasso
SHOWER TECHNOLOGY

- Centralina termostatica elettronica inclusa (3 vie).
- Doccia acciaio inossidabile da parete con cascata 280x550 mm. 2 funzioni (299.903.01).
- 3 jets anticalcare (299.515.04).
- Supporto per doccia (207.182.01).
- Doccetta anticalcare (202.639.01).
- Flessibile satin (91.34.609.15).

IMPORTANTE: Montare uno scarico di >50 l/min.

Built-in electronic thermostatic shower kit
SHOWER TECHNOLOGY

- Electronic thermostatic control box included (4 ways).
- Stainless steel ceiling shower with cascade 280x550 mm. 2 positions (299.903.01).
- 3 antilime jets (299.515.04).
- Elbow wall (207.182.01).
- Antilime hand shower (202.639.01).
- Shower hose SATIN (91.34.609.15).

IMPORTANT: Assemble a drain of >50 l/min.

Termostatický podomítkový elektronický sprchový set
SHOWER TECHNOLOGY

- Zabudovaná termostatická elektronická kontrolní jednotka (4-cestná).
- Sprchové křepátko z nerez. oceli s kaskádou 280x550 mm. 2 funkce (299.903.01).
- 3 natáčecí trysky, proti usaz. vod. Kamene. (299.515.04).
- Držák s nástěnným přívodem vody (207.182.01).
- Ruční sprcha, proti usaz. vod. kamene (202.639.01).
- Flexi hadice SATIN (91.34.609.15).

DŮLEŽITÉ: Použijte odtokovou trubici pro průtok >50 l/min.



Cr | **092.864.08**

MONO-TERM®

MONOCOMANDO CON LA COMODITÀ DI UN GRUPPO TERMOSTATICO

Utilizzare un rubinetto Mono-term® nella vostra doccia o vasca da bagno ha molti vantaggi. La stessa facilità d'uso di qualsiasi altro monocomando ma con una tecnologia avanzata che offre delle prestazioni simili a quelle di un gruppo termostatico. SCOPRITE PERCHÉ MONO-TERM® SARÀ LA TECNOLOGIA DEI MONOCOMANDI DEL FUTURO.

MIXER TAP THAT OFFERS A COMFORT LEVEL SIMILAR TO A THERMOSTATIC TAP

Installing a Mono-term® tap in your shower or bathtub has many advantages. It offers the same comfort in use as any other mixer tap but also includes advanced technology with features similar to those of a thermostatic tap. DISCOVER WHY MONO-TERM® IS DESTINED TO BE THE MIXER TAP TECHNOLOGY OF THE FUTURE.

JEDNOPÁKOVÉ BATERIE NABÍZEJÍ STEJNÝ KOMFORT JAKO TERMOSTATICKÉ

Použití baterie Mono-term® ve Vaší vaně či sprše má mnoho výhod. Stejně jednoduché použití jako u jakékoli jiné jednopákové baterie, ale s vyspělejší technologií, přinášející charakteristiky podobné baterii termostatické. ZJISTĚTE PROČ SE STANE MONO-TERM® TECHNOLOGIÍ BATERIÍ BUDOUCNOSTI.



Vantaggi rispetto a un altro tipo di monocomandi Advantages compared to other mixer taps.

Výhody oproti jiným typům jednopákových baterií



Risparmio. Si ottiene la temperatura desiderata con maggior rapidità che con un altro tipo di rubinetto monocomando. / Savings. It reaches the desired temperature faster than any other mixer tap. / Úspora. Požadované teploty se dosáhne rychleji než u jiného typu jednopákové baterie.



Controllo. Limita la temperatura a un massimo di 48/49 °C, in questo modo si evita il rischio di bruciature. / Control. Limits the temperature to a maximum of 48/49°C, preventing the risk of burns. / Kontrola. Omezuje teplotu na maximálních 48/49 °C, čímž zabraňuje riziku popálení.



Comfort. La temperatura si mantiene costante in caso di variazioni di pressione o temperatura ($\pm 2^\circ\text{C}$). / Comfort. The temperature remains constant in the presence of pressure or temperature changes ($\pm 2^\circ\text{C}$). / Komfort. Udržuje konstantní teplotu i přes výkyvy tlaku a teploty ($\pm 2^\circ\text{C}$).

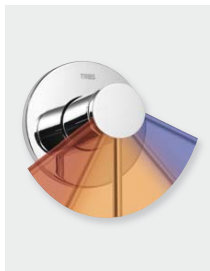

Funzionalità. La manopola regola il flusso e la temperatura allo stesso modo che qualsiasi monocomando convenzionale. / Functionality. The handle regulates the flow rate and temperature, just like a conventional mixer tap. / Funkčnost. Páka ovládá teplotu a průtok, stejně jako u jakékoli jiné jednopákové baterie.



Il segreto è nella cartuccia
The secret is in the cartridge
Tajemství spočívá v kartuši

Brevetata: con la creazione della cartuccia brevettata mono-term®, questi monocomandi sono gli UNICI con queste caratteristiche disponibili sul mercato.

Affidabilità: i dischi della cartuccia sono costruiti in materiale ceramico e sono totalmente anticalcarei, non permettono l'accumulo di calcare.

Rumorosità: il suo livello acustico è inferiore alle altre cartucce ceramiche.

Manutenzione: senza filtri né valvole antiritorno, è adatta per acque dure (calcare, sabbiolina...).

Patented: The creation of the mono-term® patented cartridge makes these mixer taps the ONLY ONES with these features available in the market.

Reliability: the cartridge disks are made of ceramic material and are completely limescale proof and resistant to limescale deposits.

Noise: they are quieter than other ceramic cartridges.

Maintenance: with no filters or non-return valves and suitable for hard waters (limestone, sand...).

Patent: Díky vytvoření kartuše mono-term® jsou tyto jednopákové baterie a jejich vlastnosti UNIKÁTNÍ na trhu.

Spolehlivost: disky v kartuši jsou vyrobeny z keramiky a jsou tedy zcela odolné vůči usazeninám vodního kamene.

Hlučnost: Nižší hladina hluku ve srovnání s ostatními keramickými kartušemi.

Údržba: bez filtrů ani zpětných ventilů, jsou zcela vhodné pro tvrdou vodu (vodní kámen, písek...).



Sicurezza. Nell'improbabile caso che si interrompa la fornitura di acqua fredda, la cartuccia ne arresta il passaggio. / **Safety.** In the unlikely event that the cold water supply is interrupted, the cartridge shuts off the water. / **Bezpečnost.** V případě, že by došlo k přerušení dodávky studené vody, což je nepravděpodobné, ventil zamezí průtoku vody.

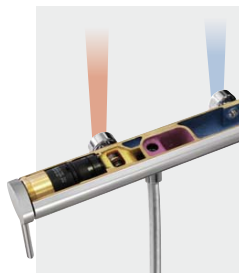

Tecnologia Touch-cool®. La superficie del rubinetto si mantiene a una temperatura che permette di toccarlo senza scottarsi. / **Touch-cool® technology.** The surface of the tap remains at a temperature suitable for touching, thus preventing burns. / **Technologie Touch-cool®.** Povrch baterie je stále příjemně chladný, proto se jí lze kdykoliv dotknout bez obav z opaření.



Precisione. I comandi dispongono del marchio 38 °C, dimostrando la precisione nella scelta della temperatura. / **Precision.** The controls have the 38°C mark, demonstrating their temperature-selecting precision. / **Přesnost.** Na páce je uvedena teplota 38 °C, což znamená, že je zařízení schopno přesně udržet zvolenou teplotu.



Design. Modelli incassati e di superficie con una manopola ergonomica dal design unico. / **Design.** Built-in and surface-mounted models with an ergonomic handle in a unique design. / **Design.** Vestavěné i povrchové modely s ergonomickými pákami a jedinečným designem.

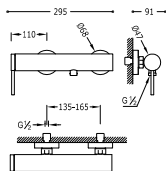

MONO-TERM® doccia
 Doccetta anticalcare (034.116.01) con supporto orientabile.
 Flessibile satin (91.34.609.15).

MONO-TERM® Single lever shower mixer
 Anti-limescale hand shower (034.116.01) with directable support
 and satin hose (91.34.609.15).

MONO-TERM® sprchová baterie
 Ruční sprcha (034.116.01) s nastavitelným držákem, proti usaz. vod.
 kamene a flexi hadice SATIN (91.34.609.15).



299.195.05
 Cr 062.168.01

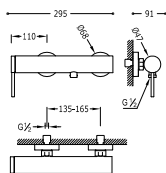

MONO-TERM® doccia
 Doccia mobile Ø 100 mm. (5 funzioni) (1.34.748) con supporto
 orientabile e flessibile satin (91.34.609.15).

MONO-TERM® Single lever shower mixer
 Massage hand shower Ø 100 mm. (5 functions) (1.34.748) with
 directable support and satin hose (91.34.609.15).

MONO-TERM® sprchová baterie
 Ruční masážní sprcha Ø 100 mm. (5 funkcí) (1.34.748)
 s nastavitelným držákem. Flexi hadice SATIN (91.34.609.15).



299.195.05
 Cr 201.167.01

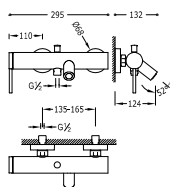

MONO-TERM® vasca
 Doccetta anticalcare (034.116.01) con supporto orientabile.
 Flessibile satin (91.34.609).

MONO-TERM® Single lever bath and shower mixer
 Anti-limescale hand shower (034.116.01) with directable support
 and satin hose (91.34.609).

MONO-TERM® baterie pro vanu-sprchu
 Ruční sprcha (034.116.01) s nastavitelným držákem, proti usaz. vod.
 kamene a flexi hadice SATIN (91.34.609).



299.195.05
 Cr 062.178.01

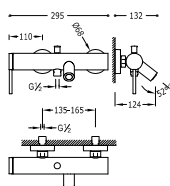

MONO-TERM® vasca
 Doccia mobile Ø 100 mm. (5 funzioni) (1.34.748) con supporto
 orientabile e flessibile satin (91.34.609).

MONO-TERM® Single lever bath and shower mixer
 Massage hand shower Ø 100 mm. (5 fonctions) (1.34.748) with
 directable support and satin hose (91.34.609).

MONO-TERM® baterie pro vanu-sprchu
 Ruční masážní sprcha Ø 100 mm. (5 funkcí) (1.34.748)
 s nastavitelným držákem. Flexi hadice SATIN (91.34.609).



299.195.05
 Cr 201.170.01

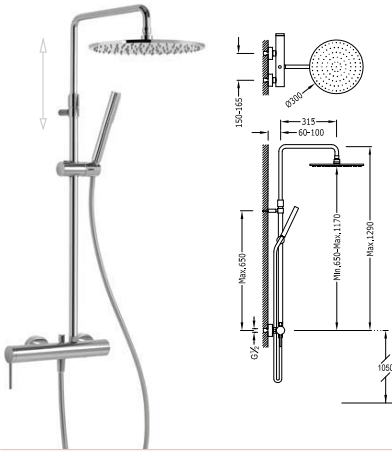

Set doccia MONO-TERM®

- Doccia fissa Ø 300 mm. con snodo. Ottone (1.34.137.30).
- Doccetta anticalcare (034.116.01).
- Flessibile satin (91.34.609.15).
- Asta telescopica.

Bar-shower MONO-TERM® set

- Fixed shower head Ø 300 mm. with ball joint. Brass. (1.34.137.30).
- Antilime hand shower (034.116.01).
- Satin hose (91.34.609.15).
- Telescopic bar.

Sprchová tyč MONO-TERM®

- Pevná sprcha Ø 300 mm. s kloubem. Materiál mosaz (1.34.137.30).
- Ruční sprcha, proti usaz. vod. kamene (034.116.01).
- Flexi hadice SATIN (91.34.609.15).
- Teleskopická tyč.



299.195.05

Cr | 062.378.01

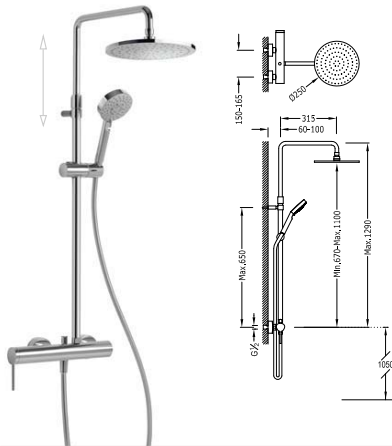

Set doccia MONO-TERM®

- Doccia fissa Ø 250 mm. con snodo. (1.34.137.26).
- Doccia mobile massaggio Ø 100 mm. (5 funzioni) (1.34.748).
- Flessibile satin (91.34.609.15).
- Asta telescopica.

Bar-shower MONO-TERM® set

- Fixed shower head Ø 250 mm. with ball joint. (1.34.137.26).
- Massage hand shower Ø 100 mm. (5 functions) (1.34.748).
- Satin hose (91.34.609.15).
- Telescopic bar.

Sprchová tyč MONO-TERM®

- Pevná sprcha Ø 250 mm. s kloubem. (1.34.137.26).
- Ruční masážní sprcha Ø 100 mm. (5 funkci) (1.34.748).
- Flexi hadice SATIN (91.34.609.15).
- Teleskopická tyč.



299.195.05

Cr | 201.195.01



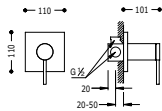

MONO-TERM® da incasso (1 via)
Con chiusura e regolazione di portata.
- Corpo incassato incluso

Built-in MONO-TERM® (1 way)
with water shut off and flow control.
- Built-in body included

Baterie MONO-TERM® (jednocestný)
s uzávěrem a regulací průtoku.
- Včetně podomítkového tělesa



299.195.05 BELARADA
Cr 201.177.01

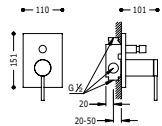

MONO-TERM® da incasso (2 vie)
Con chiusura e regolazione di portata.
- Corpo incassato incluso

Built-in MONO-TERM® (2 way)
with water shut off and flow control.
- Built-in body included

Baterie MONO-TERM® (dvoucestný)
s uzávěrem a regulací průtoku.
- Včetně podomítkového tělesa



299.195.05 BELARADA
Cr 201.180.01

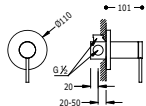

MONO-TERM® da incasso (1 via)
Con chiusura e regolazione di portata.
- Corpo incassato incluso

Built-in MONO-TERM® (1 way)
with water shut off and flow control.
- Built-in body included

Baterie MONO-TERM® (jednocestný)
s uzávěrem a regulací průtoku.
- Včetně podomítkového tělesa



299.195.05 BELARADA
Cr 201.177.02

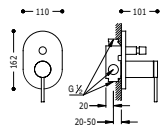

MONO-TERM® da incasso (2 vie)
Con chiusura e regolazione di portata.
- Corpo incassato incluso

Built-in MONO-TERM® (2 way)
with water shut off and flow control.
- Built-in body included

Baterie MONO-TERM® (dvoucestný)
s uzávěrem a regulací průtoku.
- Včetně podomítkového tělesa



299.195.05 BELARADA
Cr 201.180.02

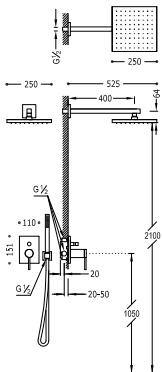

Kit MONO-TERM® da incasso doccia

Con chiusura e regolazione di portata.
- Corpo incassato incluso
- Doccia fissa 250x250 mm. con snodo. (1.34.138.26).
- Supporto per doccia (006.182.01).
- Doccia anticalcare (006.639.01).
- Flessibile satin (91.34.609.15).

Built-in MONO-TERM® for showers
with water shut off and flow control.
- Built-in body included
- Fixed shower head 250x250 mm. with ball joint. (1.34.138.26).
- Elbow wall (006.182.01).
- Antilime hand shower (006.639.01).
- Satin hose (91.34.609.15).

Sprchová sada podomítková MONO-TERM®
s uzávěrem a regulací průtoku.
- Včetně podomítkového tělesa
- Pevná sprcha 250x250 mm. s kloubem. (1.34.138.26).
- Držák s nástěnným přívodem vody (006.182.01).
- Ruční sprcha, proti usaz. vod. kamene (006.639.01).
- Flexi hadice SATIN (91.34.609.15).



299.195.05 BELARADA
Cr 201.180.06

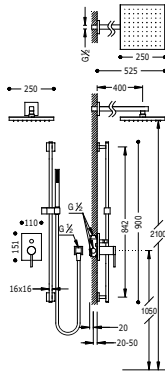

Kit MONO-TERM® da incasso doccia

Con chiusura e regolazione di portata.

- Corpo incassato incluso
- Doccia fissa 250x250 mm. con snodo. (1.34.138.26).
- Asta antiscivolo lunga 842 mm. (1.07.935).
- Presa a parete (006.183.01).
- Doccia anticalcare (006.639.01).
- Flessibile satin (91.34.609).

Built-in MONO-TERM® for showers with water shut off and flow control.

- Built-in body included
- Fixed shower head 250x250 mm. with ball joint. (1.34.138.26).
- Sliding bar long 842 mm. (1.07.935).
- Elbow wall (006.183.01).
- Antilime hand shower (006.639.01).
- Satin hose (91.34.609).

Sprchová sada podomítková MONO-TERM®

- s uzávěrem a regulací průtoku.
- Včetně podomítkového tělesa
- Pevná sprcha 250x250 mm. s kloubem. (1.34.138.26).
- Posuvná tyč 842 mm (1.07.935).
- Kolínko nást. přívodem (006.183.01).
- Ruční sprcha, proti usaz. vod. kamene (006.639.01).
- Flexi hadice SATIN (91.34.609).



299.195.05
Cr | 201.180.07

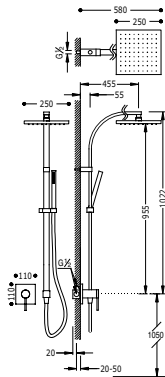

Kit MONO-TERM® da incasso doccia

Con chiusura e regolazione di portata.

- Corpo incassato incluso
- Doccia fissa 250x250 mm. con snodo. (1.34.138.26).
- Douchette anticalcaire (006.639.01).
- Flessibile satin (91.34.609.15).
- Con presa a parete.

Built-in MONO-TERM® for showers with water shut off and flow control.

- Built-in body included
- Fixed shower head 250x250 mm. with ball joint. (1.34.138.26).
- Antilime hand shower (006.639.01).
- Satin hose (91.34.609.15).
- With wall entrance.

Sprchová sada podomítková MONO-TERM®

- s uzávěrem a regulací průtoku.
- Včetně podomítkového tělesa
- Pevná sprcha 250x250 mm. s kloubem. (1.34.138.26).
- Ruční sprcha, proti usaz. vod. kamene (006.639.01).
- Flexi hadice SATIN (91.34.609.15).
- S nástěnným přívodem.



299.195.05
Cr | 201.177.04

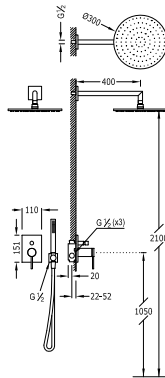

Kit MONO-TERM® da incasso doccia

Con chiusura e regolazione di portata.

- Corpo incassato incluso
- Doccia fissa Ø 300 mm. con snodo. Ottone. (1.34.137.30).
- Supporto per doccia (061.182.01).
- Doccia anticalcare (034.116.01).
- Flessibile satin (91.34.609.15).

Built-in MONO-TERM® for showers with water shut off and flow control.

- Built-in body included
- Fixed shower head Ø 300 mm. with ball joint. Brass. (1.34.137.30).
- Elbow wall (061.182.01).
- Antilime hand shower (034.116.01).
- Satin hose (91.34.609.15).

Sprchová sada podomítková MONO-TERM®

- s uzávěrem a regulací průtoku.
- Včetně podomítkového tělesa
- Pevná sprcha Ø 300 mm. s kloubem. Materiál mosaz. (1.34.137.30).
- Držák s nástěnným přívodem vody. (061.182.01).
- Ruční sprcha, proti usaz. vod. kamene (034.116.01).
- Flexi hadice SATIN (91.34.609.15).



299.195.05
Cr | 062.180.03

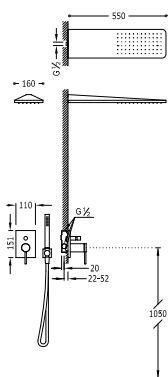

Kit MONO-TERM® da incasso doccia

Con chiusura e regolazione di portata.

- Corpo incassato incluso
- Doccia acciaio inossidabile 160x550 mm. (299.903.06).
- Supporto per doccia. (061.182.01).
- Doccia anticalcare. (034.116.01).
- Flessibile satin (91.34.609.15).

Built-in MONO-TERM® for showers

with water shut off and flow control.

- Built-in body included
- Stainless steel shower 160x550 mm. (299.903.06).
- Elbow wall. (061.182.01).
- Antilime hand shower. (034.116.01).
- Satin hose (91.34.609.15).

Sprchová sada podomítková MONO-TERM®

s uzávěrem a regulací průtoku.

- Včetně podomítkového tělesa
- Sprcha z nerez. oceli 160x550 mm. (299.903.06).
- Držák s nástěnným přívodem vody (061.182.01).
- Ruční sprcha, proti usaz. vod. kamene (034.116.01).
- Flexi hadice SATIN (91.34.609.15).



299.195.05

Cr 062.180.10

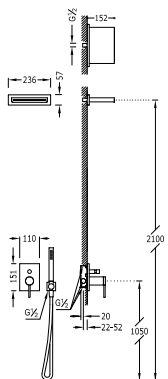

Kit MONO-TERM® da incasso doccia

Con chiusura e regolazione di portata.

- Corpo incassato incluso
- Doccia acciaio inossidabile con cascata 152x200 mm. (299.903.04).
- Supporto per doccia. (061.182.01).
- Doccia anticalcare. (034.116.01).
- Flessibile satin (91.34.609.15).

Built-in MONO-TERM® for showers

with water shut off and flow control.

- Built-in body included
- Stainless steel shower with cascade 152x200 mm. (299.903.04).
- Elbow wall (061.182.01).
- Antilime hand shower (034.116.01).
- Satin hose (91.34.609.15).

Sprchová sada podomítková MONO-TERM®

s uzávěrem a regulací průtoku.

- Včetně podomítkového tělesa
- Sprcha z nerez. oceli s kaskádou 152x200 mm. (299.903.04).
- Držák s nástěnným přívodem vody (061.182.01).
- Ruční sprcha, proti usaz. vod. kamene (034.116.01).
- Flexi hadice SATIN (91.34.609.15).



299.195.05

Cr 062.180.06

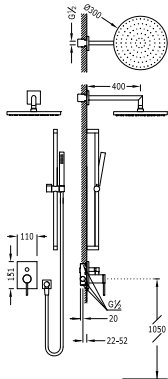

Kit MONO-TERM® da incasso doccia

Con chiusura e regolazione di portata.

- Corpo incassato incluso
- Doccia fissa Ø 300 mm. con snodo. Ottone. (1.34.137.30).
- Asta antiscivolo lunga 673 mm. (034.637.06).
- Presa a parete (061.183.01).
- Doccia anticalcare. (034.116.01).
- Flessibile satin. (91.34.609.15).

Built-in MONO-TERM® for showers

with water shut off and flow control.

- Built-in body included
- Fixed shower head Ø 300 mm. with ball joint. Brass. (1.34.137.30).
- Bar-shower antilime. long. 673 mm. (034.637.06).
- Elbow wall (061.183.01).
- Antilime hand shower (034.116.01).
- Satin hose (91.34.609.15).

Sprchová sada podomítková MONO-TERM®

s uzávěrem a regulací průtoku.

- Včetně podomítkového tělesa
- Pevná sprcha Ø 300 mm. s kloubem. Materiál mosaz. (1.34.137.30).
- Kolínko nástěnným přívodem (061.183.01).
- Posuvná tyč délky 673 mm (034.637.06).
- Ruční sprcha, proti usaz. vod. kamene (034.116.01).
- Flexi hadice SATIN (91.34.609.15).



299.195.05

Cr 062.180.07

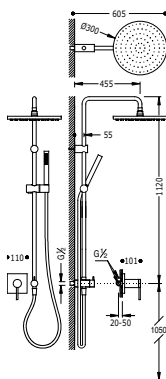

Kit MONO-TERM® da incasso doccia

Con chiusura e regolazione di portata.

- Corpo incassato incluso
- Doccia fissa Ø 300 mm. con snodo. Ottone. (1.34.137.30).
- Doccia anticalcare. (034.116.01).
- Flessibile satin. (91.34.609.15).
- Con presa a parete.

Built-in MONO-TERM® for showers

with water shut off and flow control.

- Built-in body included
- Fixed shower head Ø 300 mm. with ball joint. Brass. (1.34.137.30).
- Antilime hand shower (034.116.01).
- Satin hose (91.34.609.15).
- With wall entrance.

Sprchová sada podomítková MONO-TERM®

s uzávěrem a regulací průtoku.

- Včetně podomítkového tělesa
- Pevná sprcha Ø 300 mm. s kloubem. Materiál mosaz. (1.34.137.30).
- Ruční sprcha, proti usaz. vod. kamene (034.116.01).
- Flexi hadice SATIN (91.34.609.15).
- S nástěnným přívodem.



299.195.05

Cr | 062.180.08

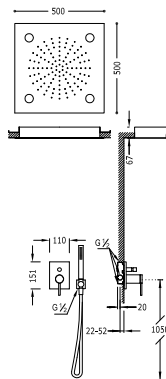

Kit MONO-TERM® da incasso doccia CHROMOTHERAPY

Con chiusura e regolazione di portata.

- Corpo incassato incluso
- Soffione doccia anticalcare 500x500 mm. (299.962.01).
- Supporto per doccia. (061.182.01).
- Doccia anticalcare. (034.116.01).
- Flessibile satin (91.34.609.15).

Built-in MONO-TERM® for showers CHROMOTHERAPY

with water shut off and flow control.

- Built-in body included
- Ceiling shower antilime 500x500 mm. (299.962.01).
- Elbow wall (061.182.01).
- Antilime hand shower (034.116.01).
- Satin hose (91.34.609.15).

Sprchová sada podomítková MONO-TERM®

CHROMOTHERAPY

s uzávěrem a regulací průtoku.

- Včetně podomítkového tělesa
- Stropní sprchové křepitko z nerez. oceli 500x500 mm. (299.962.01).
- Držák s nástěnným přívodem vody (061.182.01).
- Ruční sprcha, proti usaz. vod. kamene (034.116.01).
- Flexi hadice SATIN (91.34.609.15).



299.195.05

Cr | 062.180.11

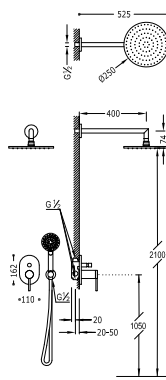

Kit MONO-TERM® da incasso doccia

con chiusura e regolazione di portata.

- Corpo incassato incluso
- Doccia fissa Ø 250 mm. con snodo. (1.34.137.26).
- Supporto per doccia (205.182.01).
- Doccia mobile Ø 100 mm. (5 funzioni) (1.34.748).
- Flessibile satin (91.34.609.15).

Built-in MONO-TERM® for showers

with water shut off and flow control.

- Built-in body included
- Fixed shower head Ø 250 mm. with ball joint. (1.34.137.26).
- Elbow wall (205.182.01).
- Massage hand shower Ø 100 mm. (5 functions) (1.34.748).
- Satin hose (91.34.609.15).

Sprchová sada podomítková MONO-TERM®

s uzávěrem a regulací průtoku.

- Včetně podomítkového tělesa
- Pevná sprcha Ø 250 mm. s kloubem. (1.34.137.26).
- Držák s nástěnným přívodem vody (205.182.01).
- Ruční masážní sprcha Ø 100 mm (5 funkcí) (1.34.748).
- Flexi hadice SATIN (91.34.609.15).



299.195.05

Cr | 201.180.03

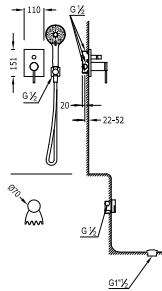

MONO-TERM® da incasso bagno-doccia

Con chiusura e regolazione di portata. (2 vie).

- Scarico vasca e valvola di riempimento rotonda A CASCATA con troppopieno. (1.34.534.30).
- Sifone PVC vasca (1.34.634.60).
- Supporto per doccia. (061.182.01).
- Doccia massaggio Ø 100 mm. (5 funzioni) (299.631.06).
- Flessibile satin (91.34.609).

Built-in MONO-TERM® for bathtubs-showers

with water shut off and flow control. (2 ways).

- Bath drain and round CASCADE filling valve with overflow drain. (1.34.534.30).
- Bath PVC drain trap (1.34.634.60).
- Elbow wall (061.182.01).
- Massage hand shower Ø 100 mm. (5 functions) (299.631.06).
- Satin hose (91.34.609).

Baterie pro vanu-sprchu podomítková MONO-TERM®

s uzávěrem a regulací průtoku (2-cestná).

- Odtoková a napouštěcí vanová kulatá souprava KASKÁDA s přepadem (1.34.534.30).
- Vanový sifon z PVC (1.34.634.60).
- Držák s nástěnným přívodem vody. (061.182.01).
- Ruční masážní sprcha Ø 100 mm. (5 funkcí) (299.631.06).
- Flexi hadice SATIN (91.34.609).



299.195.05

Cr | **062.180.13** |

MONOCOMANDI A 3 VIE

3-WAY MIXER TAPS

JEDNOPÁKOVÉ BATERIE SE 3 PŘÍVODY

Più funzioni con la stessa facilità d'uso
More functions with the same ease of use
Více funkcí se stejně jednoduchým používáním



Soffioni a soffitto / parete con effetto pioggia.
 Ceiling/wall-mounted rainfall nozzle.
 Stropní křepitko / stěna s dešťovým efektem.



Doccia a mano.
 Shower head.
 Ruční sprcha.



Seconda funzione del soffione / bocchette / canna per vasca.
 Bath spray/jet/spout secondary function.
 Druhá funkce křepitka / trysky / ramínko na vanu.

Design minimalista e dall'estetica moderna. Facile da pulire. /
 Minimalist design for a modern look. Easy to clean. / Minimalistický
 design a moderní vzhled. Snadné čištění.

Un solo comando apre-chiude il flusso di acqua, regola la temperatura
 e il flusso. / A single control opens and closes the water flow, adjusts
 the temperature and regulates flow speed. / Jednou pákou se otevírá-
 zavírá proud vody, nastavuje teplota i reguluje průtok.

Selettore di funzioni per scegliere una qualsiasi delle tre possibili us-
 cite d'acqua. / Functions selector to choose any of the three possible
 water outlets. / Volič funkcí k výběru jakéhokoli ze tří výstupů vody.

Supporto e doccia a mano di ottone, con tubo flessibile SATINATO
 (igienico e facile da pulire) / Brass support and shower head with
 SATIN hose (hygienic and easy to clean) / Držák a ruční sprcha z
 mosazi, s hadicí SATIN (hygienická a snadno se čistí)

Nei kit, il controllo e il supporto doccia sono integrati in un solo
 corpo incassato non divisibile. / The head and shower supports are
 integrated in a single built-in unit in the kits. / U sad je ovládání a
 sprchový držák zabudován do jednoho vestavného nerozdělitelného
 tělesa.

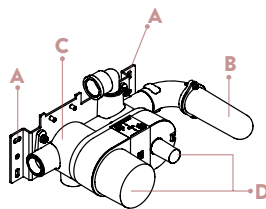

A Profilo di installazione a parete o cartongesso con 3 assi di livellamento.
 Wall-mounted or plasterboard installation profile with 3 levelling axes.
 Profíl pro upevnění na zed' či sádkokarton se 3 úrovními vyvážení.

B Supporto con attacco doccia integrato.
 Base with built-in shower connection.
 Nosník se sprchovým talířem je zahrnut.

C Ammortizzatori anti-vibrazione.
 Anti-vibration shock absorbers.
 Antivibrační tlumiče.

D Protettori a tenuta. La parete rimane protetta dall'umidità.
 Water-tight protectors. The wall is protected from moisture.
 Těsnící protекторы. Stěna je dokonale chráněna proti vlhkosti.



Esempio di installazione del monocomando a 3 vie. / 3-way mixer tap installation example. / Příklad instalace trojcestné jednopákové baterie.



Ref./Nr./Kód: |

N

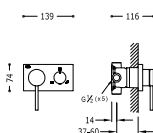

Monocomando incasso 3V

- Corpo incassato incluso (3 vie)
* NOTA: per completare questo articolo si deve aggiungere e scegliere tra un soffione/doccia a mano/bocchette/canna per vasca da bagno.

Built-in mixer taps 3V

- Built-in body included (3 ways)
* NOTE: To complete this item, select and add one of the following: shower head/hand shower/jets/bath spout.

Vestavěná jednopáková baterie 3V

- Včetně podomítkového tělesa (3-cestná)
* POZNÁMKA: Ke kompletaci tohoto zboží je nutno vybrat a přidat křepitko/ruční sprchu/trysky/kohoutek pro vanu.



299.198.02
Cr 210.273.99



3 VIE / WAYS / CESTNÁ

N

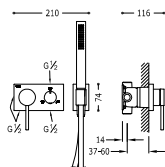

Monocomando incasso 3V

- Corpo incassato incluso (3 vie)
- Doccetta anticalcare (034.116.01)
- Flessibile satin (91.34.609.15)
* NOTA: per completare questo articolo si deve aggiungere e scegliere tra un soffione/doccia a mano/bocchette/canna per vasca da bagno.

Built-in mixer taps 3V

- Built-in body included (3 ways)
- Antilime hand shower (034.116.01)
- Shower hose SATIN (91.34.609.15)
* NOTE: To complete this item, select and add one of the following: shower head/hand shower/jets/bath spout.

Vestavěná jednopáková baterie 3V

- Včetně podomítkového tělesa (3-cestná)
- Ruční sprcha, proti usaz. vod. Kamene (034.116.01)
- Flexi hadice SATIN (91.34.609.15)
* POZNÁMKA: Ke kompletaci tohoto zboží je nutno vybrat a přidat křepitko/ruční sprchu/trysky/kohoutek pro vanu.



299.198.02
Cr 210.273.91



N

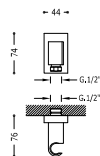

Supporto per doccia
con presa d'acqua a parete e valvola antiritorno

**Shower holder
with wall water outlet and check valve.**

Úchyt ruční sprchy se stěnovou přípojkou vody s nastavitelným výstupem pro vodu a zpětným ventilem.

Cr 207.182.01

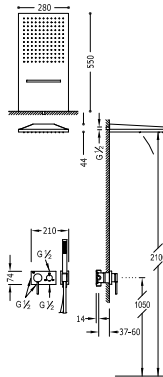

Monocomando incasso 3V

- Corpo incassato incluso (3 vie)
- Doccia acciaio inossidabile da parete con cascata 280x550 mm. 2 funzioni (299.903.01).
- Doccetta anticalcare (202.639.01).
- Flessibile satin (91.34.609.15).

Built-in mixer taps 3V

- Built-in body included (3 ways).
- Stainless steel ceiling shower with cascade 280x550 mm. 2 positions (299.903.01).
- Antilime hand shower (034.116.01).
- Shower hose SATIN (91.34.609.15).

Vestavná jednopáková baterie 3V

- Včetně podomítkového tělesa (3-cestná)
- Sprchové křepítko z nerez. oceli s kaskádou 280x550 mm. 2 funkce (299.903.01).
- Ruční sprcha, proti usaz. vod. Kamene (034.116.01).
- Flexi hadice SATIN (91.34.609.15).



299.198.02

Cr | 210.273.01

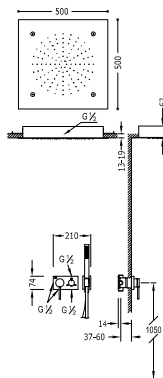

Monocomando incasso 3V

- Corpo incassato incluso (3 vie)
- Soffione doccia acciaio inossidabile 500x500 mm. 2 funzioni (299.954.01).
- Doccetta anticalcare (034.116.01).
- Flessibile satin (91.34.609.15).

Built-in mixer taps 3V

- Built-in body included (3 ways).
- Stainless steel ceiling shower 500x500 mm. 2 positions (299.954.01).
- Antilime hand shower (034.116.01).
- Shower hose SATIN (91.34.609.15).

Vestavná jednopáková baterie 3V

- Včetně podomítkového tělesa (3-cestná)
- Sprchové křepítko z nerez. oceli 500x500 mm. 2 funkce (299.954.01).
- Ruční sprcha, proti usaz. vod. kamene (034.116.01).
- Flexi hadice SATIN (91.34.609.15).



299.198.02

Cr | 210.273.02



N

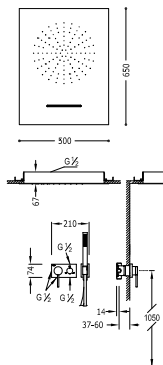

Monocomando incasso 3V

- Corpo incassato incluso (3 vie)
- Soffione doccia acciaio inossidabile con cascata 500x650 mm.
- 2 funzioni (299.970.01).
- Doccetta anticalcare (034.116.01).
- Flessibile satin (91.34.609.15).

Built-in mixer taps 3V

- Built-in body included (3 ways).
- Stainless steel ceiling shower with cascade 500x650 mm.
- 2 positions (299.970.01).
- Antilime hand shower (034.116.01).
- Shower hose SATIN (91.34.609.15).

Vestavěná jednopáková baterie 3V

- Včetně podomítkového tělesa (3-cestná)
- Sprchové křepitko z nerez. oceli s kaskádou 500x650 mm.
- 2 funkce (299.970.01).
- Ruční sprcha, proti usaz. vod. kamene (034.116.01).
- Flexní hadice SATIN (91.34.609.15).



299.198.02

Cr 210.273.03



N

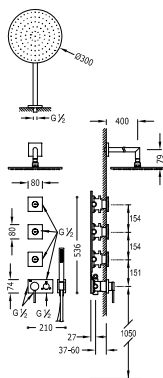

Monocomando incasso 3V

- Corpo incassato incluso (3 vie)
- Doccia fissa Ø 300 mm. con snodo. Ottone (1.34.137.30).
- 3 jets anticalcare (299.515.06).
- Doccetta anticalcare (034.116.01).
- Flessibile satin (91.34.609.15).

Built-in mixer taps 3V

- Built-in body included (3 ways).
- Fixed shower head Ø 300 mm. with ball joint. Brass (1.34.137.30).
- 3 antilime jets (299.515.06).
- Antilime hand shower (034.116.01).
- Shower hose SATIN (91.34.609.15).

Vestavěná jednopáková baterie 3V

- Včetně podomítkového tělesa (3-cestná)
- Pevná sprcha Ø 300 mm. s kloubem. Materiál Mosaz (1.34.137.30).
- 3 natáčecí trysky, proti usaz. vod. kamene (299.515.06).
- Ruční sprcha, proti usaz. vod. Kamene (034.116.01).
- Flexní hadice SATIN (91.34.609.15).



299.198.02

Cr 210.273.04



N

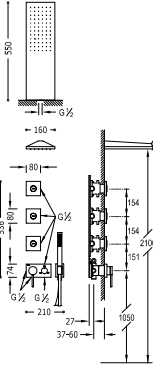

Monocomando incasso 3V

- Corpo incassato incluso (3 vie)
- Doccia acciaio inossidabile da parete 160x550 mm. (299.903.03).
- 3 jets anticalcare (299.515.06).
- Doccetta anticalcare (034.116.01).
- Flessibile satin (91.34.609.15).

Built-in mixer taps 3V

- Built-in body included (3 ways).
- Stainless steel wall shower 160x550 mm. (299.903.03).
- 3 antilime jets (299.515.06).
- Antilime hand shower (034.116.01).
- Shower hose SATIN (91.34.609.15).

Vestavná jednopáková baterie 3V

- Včetně podomítkového tělesa (3-cestná)
- Nástěnné sprchové křepitko z nerez. oceli 160x550 mm. (299.903.03).
- 3 natáčecí trysky, proti usaz. vod. kamene. (299.515.06).
- Ruční sprcha, proti usaz. vod. Kamene (034.116.01).
- Flexi hadice SATIN (91.34.609.15).



299.198.02

Cr | 210.273.05 |



N

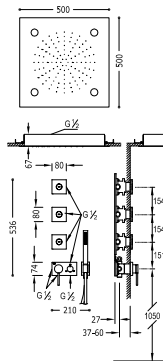

Monocomando incasso 3V CHROMOTHERAPY

- Corpo incassato incluso (3 vie)
- Soffione doccia acciaio inossidabile 500x500 mm. 2 funzioni (299.962.01).
- 3 jets anticalcare (299.515.06).
- Doccetta anticalcare (034.116.01).
- Flessibile satin (91.34.609.15).

Built-in mixer taps 3V CHROMOTHERAPY

- Built-in body included (3 ways).
- Stainless steel ceiling shower 500x500 mm. 2 positions (299.962.01).
- 3 antilime jets (299.515.06).
- Antilime hand shower (034.116.01).
- Shower hose SATIN (91.34.609.15).

Vestavná jednopáková baterie 3V CHROMOTHERAPY

- Včetně podomítkového tělesa (3-cestná)
- Sprchové křepitko z nerez. oceli 500x500 mm. 2 funkce (299.962.01).
- 3 natáčecí trysky, proti usaz. vod. kamene. (299.515.06).
- Ruční sprcha, proti usaz. vod. Kamene (034.116.01).
- Flexi hadice SATIN (91.34.609.15).



299.198.02

Cr | 210.273.08 |



N

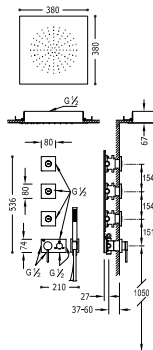

Monocomando incasso 3V

- Corpo incassato incluso (3 vie)
- Soffione doccia acciaio inossidabile 380x380 mm. (299.953.01)
- 3 jets anticalcare (299.515.06)
- Doccetta anticalcare (034.116.01)
- Flessibile satin (91.34.609.15).

Built-in mixer taps 3V

- Built-in body included (3 ways)
- Stainless steel ceiling shower 500x500 mm. (299.953.01)
- 3 antilime jets (299.515.06)
- Antilime hand shower (034.116.01)
- Shower hose SATIN (91.34.609.15).

Vestavěná jednopáková baterie 3V

- Včetně podomítkového tělesa (3-cestná)
- Sprchové křepítko z nerez. oceli 380x380 mm. (299.953.01)
- 3 natáčecí trysky, proti usaz. vod. kamene. (299.515.06)
- Ruční sprcha, proti usaz. vod. Kamene. (034.116.01).
- Flexi hadice SATIN (91.34.609.15).



299.198.02

Cr 210.273.09



N

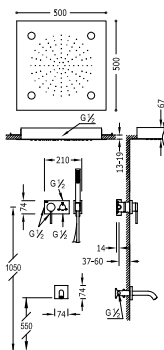

Monocomando incasso 3V CHROMOTHERAPY

- Corpo incassato incluso (3 vie)
- Soffione doccia acciaio inossidabile 500x500 mm. 2 funzioni (299.962.01)
- Canna per vasca da bagno.
- Doccetta anticalcare (034.116.01)
- Flessibile satin (91.34.609.15).

Built-in mixer taps 3V CHROMOTHERAPY

- Built-in body included (3 ways)
- Stainless steel ceiling shower 500x500 mm. 2 positions (299.962.01)
- Bath spout.
- Antilime hand shower (034.116.01)
- Shower hose SATIN (91.34.609.15).

Vestavěná jednopáková baterie 3V CHROMOTHERAPY

- Včetně podomítkového tělesa (3-cestná)
- Sprchové křepítko z nerez. oceli 500x500 mm. 2 funkce (299.962.01)
- Kohoutek pro vanu.
- Ruční sprcha, proti usaz. vod. Kamene. (034.116.01).
- Flexi hadice SATIN (91.34.609.15).



299.198.02

Cr 210.273.06



N

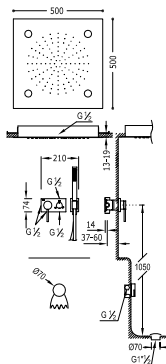

Monocomando incasso 3V CHROMOTHERAPY

- Corpo incassato incluso (3 vie)
- Soffione doccia acciaio inossidabile 500x500 mm. 2 funzioni (299.962.01).
- Scarico vasca e valvola di riempimento rotonda A CASCATA con troppopieno (1.34.534.30).
- Sifone PVC vasca (1.34.634.60).
- Doccetta anticalcare (034.116.01).
- Flessibile satin (91.34.609.15).

Built-in mixer taps 3V CHROMOTHERAPY

- Built-in body included (3 ways).
- Stainless steel ceiling shower 500x500 mm. 2 positions (299.962.01).
- Bath drain and round CASCADE filling valve with overflow drain. (1.34.534.30).
- Bath PVC drain trap (1.34.634.60).
- Antilime hand shower (034.116.01).
- Shower hose SATIN (91.34.609.15).

Vestavná jednopáková baterie 3V CHROMOTHERAPY

- Včetně podomítkového tělesa (3-cestná)
- Sprchové křepítko z nerez. oceli 500x500 mm. 2 funkce (299.962.01).
- Odtoková a napouštěcí vanová kulatá KASKÁDA s přepadem (1.34.534.30).
- Vanový sifon z PVC (1.34.634.60).
- Ruční sprcha, proti usaz. vod. Kamene (034.116.01).
- Flexi hadice SATIN (91.34.609.15).



299.198.02

Cr | 210.273.07 |



N

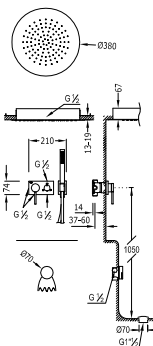

Monocomando incasso 3V

- Corpo incassato incluso (3 vie)
- Soffione doccia acciaio inossidabile Ø 380 mm. (1.34.940).
- Scarico vasca e valvola di riempimento rotonda A CASCATA con troppopieno (1.34.534.30).
- Sifone PVC vasca (1.34.634.60).
- Doccetta anticalcare (034.116.01).
- Flessibile satin (91.34.609.15).

Built-in mixer taps 3V

- Built-in body included (3 ways).
- Stainless steel ceiling shower Ø 380 mm. (1.34.940).
- Bath drain and round CASCADE filling valve with overflow drain. (1.34.534.30).
- Bath PVC drain trap (1.34.634.60).
- Antilime hand shower (034.116.01).
- Shower hose SATIN (91.34.609.15).

Vestavná jednopáková baterie 3V

- Včetně podomítkového tělesa (3-cestná)
- Sprchové křepítko z nerez. oceli Ø 380 mm. (1.34.940).
- Odtoková a napouštěcí vanová kulatá KASKÁDA s přepadem (1.34.534.30).
- Vanový sifon z PVC (1.34.634.60).
- Ruční sprcha, proti usaz. vod. Kamene (034.116.01).
- Flexi hadice SATIN (91.34.609.15).



299.198.02

Cr | 210.273.10 |



N



Monocomando incasso 3V

- Corpo incassato incluso (3 vie)
- Soffione doccia acciaio inossidabile Ø 380 mm. (1.34.940).
- Canna per vasca da bagno.
- Doccetta anticalcare (034.116.01).
- Flessibile satin (91.34.609.15).

Built-in mixer taps 3V

- Built-in body included (3 ways).
- Stainless steel ceiling shower Ø 380 mm. (1.34.940).
- Bath spout.
- Antilime hand shower (034.116.01).
- Shower hose SATIN (91.34.609.15).

Vestavěná jednopáková baterie 3V

- Včetně podomítkového tělesa (3-cestná)
- Sprchové křepitko z nerez. oceli Ø 380 mm. (1.34.940).
- Kohoutek pro vanu.
- Ruční sprcha, proti usaz. vod. Kamene (034.116.01).
- Flexi hadice SATIN (91.34.609.15).

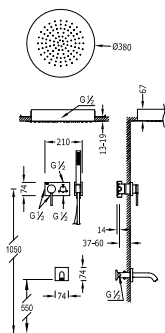

299.198.02

Cr 210.273.11



N



Monocomando incasso 3V

- Corpo incassato incluso (3 vie)
- Doccia acciaio inossidabile da parete 160x550 mm. (299.903.03).
- Scarico vasca e valvola di riempimento rotonda A CASCATA con troppopieno (1.34.534.30).
- Sifone PVC vasca (1.34.634.60).
- Doccetta anticalcare (034.116.01).
- Flessibile satin (91.34.609.15).

Built-in mixer taps 3V

- Built-in body included (3 ways).
- Stainless steel wall shower 160x550 mm. (299.903.03).
- Bath drain and round CASCADE filling valve with overflow drain. (1.34.534.30).
- Bath PVC drain trap (1.34.634.60).
- Antilime hand shower (034.116.01).
- Shower hose SATIN (91.34.609.15).

Vestavěná jednopáková baterie 3V

- Včetně podomítkového tělesa (3-cestná)
- Nástěnné sprchové křepitko z nerez. Oceli 160x550 mm. (299.903.03).
- Odtoková a napouštěcí vanová kulatá KASKÁDA s přepadem (1.34.534.30).
- Vanový sifon z PVC (1.34.634.60).
- Ruční sprcha, proti usaz. vod. Kamene (034.116.01).
- Flexi hadice SATIN (91.34.609.15).

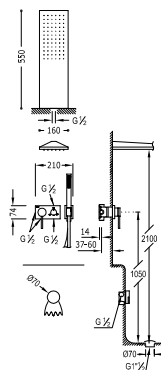

299.198.02

Cr 210.273.12



N



Monocomando incasso 3V

- Corpo incassato incluso (3 vie)
- Doccia fissa Ø 300 mm. con snodo. Ottone (1.34.137.30).
- Canna per vasca da bagno.
- Doccetta anticalcare (034.116.01).
- Flessibile satin (91.34.609.15).

Built-in mixer taps 3V

- Built-in body included (3 ways).
- Fixed shower head Ø 300 mm. with ball joint. Brass (1.34.137.30).
- Bath spout.
- Antilime hand shower (034.116.01).
- Shower hose SATIN (91.34.609.15).

Vestavná jednopáková baterie 3V

- Včetně podomítkového tělesa (3-cestná)
- Pevná sprcha Ø 300 mm. s kloubem. Materiál Mosaz (1.34.137.30).
- Kohoutek pro vanu.
- Ruční sprcha, proti usaz. vod. Kamene (034.116.01).
- Flexi hadice SATIN (91.34.609.15).

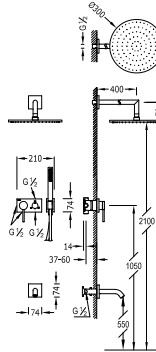

299.198.02

Cr | **210.273.13**



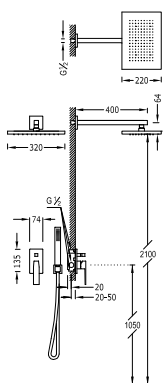

Kit doccia ad incasso SLIM

Con chiusura e regolazione di portata.

- Corpo incassato incluso
- Doccia fissa 320x220 mm. con snodo. Ottone (299.632.02).
- Supporto per doccia (066.182.01).
- Doccetta anticalcare (202.639.01).
- Flessibile satin (91.34.609.15).

Concealed shower set SLIM

with water shut off and flow control.

- Built-in body included
- Fixed shower head 320x220 mm. with ball joint. Brass (299.632.02).
- Elbow wall (066.182.01).
- Antilime hand shower (202.639.01).
- Shower hose SATIN (91.34.609.15).

Podomítkový jednopákový sprchový set SLIM

s uzávěrem a regulací průtoku.

- Včetně podomítkového tělesa
- Pevná sprcha 320x220 mm. s kloubem. Materiál mosaz (299.632.02).
- Držák s nástěnným přívodem vody (066.182.01).
- Ruční sprcha, proti usaz. vod. kamene (202.639.01).
- Flexi hadice SATIN (91.34.609.15).



91.30.190

Cr 202.180.06

N

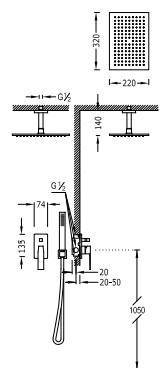

Kit doccia ad incasso

Con chiusura e regolazione di portata.

- Corpo incassato incluso
- Doccia fissa 320x220 mm. con snodo. Ottone (299.632.02).
- Supporto per doccia (006.182.01).
- Doccetta anticalcare (202.639.01).
- Flessibile satin (91.34.609.15).

Concealed shower set

with water shut off and flow control.

- Built-in body included
- Fixed shower head 320x220 mm. with ball joint. Brass (299.632.02).
- Elbow wall (006.182.01).
- Antilime hand shower (202.639.01).
- Satin hose (91.34.609.15).

Podomítkový jednopákový sprchový set

s uzávěrem a regulací průtoku.

- Včetně podomítkového tělesa
- Pevná sprcha 320x220 mm. s kloubem. Materiál mosaz (299.632.02).
- Držák s nástěnným přívodem vody (006.182.01).
- Ruční sprcha, proti usaz. vod. kamene (202.639.01).
- Flexi hadice SATIN (91.34.609.15).



91.30.190

Cr 202.180.80

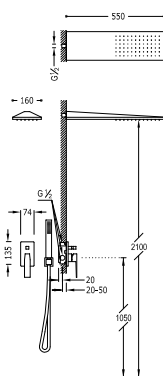

Kit doccia ad incasso

Con chiusura e regolazione di portata.

- Corpo incassato incluso
- Doccia acciaio inossidabile da parete 160x550 mm.
- Supporto per doccia.
- Doccetta anticalcare.
- Flessibile satin (91.34.609.15).

Concealed shower set

with water shut off and flow control.

- Built-in body included
- Stainless steel wall shower 160x550 mm.
- Elbow wall.
- Antilime hand shower.
- Satin hose (91.34.609.15).

Podomítkový jednopákový sprchový set

s uzávěrem a regulací průtoku.

- Včetně podomítkového tělesa
- Nástěnné sprchové křepítko z nerez. oceli 160x550 mm.
- Držák s nástěnným přívodem vody.
- Ruční sprcha, proti usaz. vod. kamene (202.639.01).
- Flexi hadice SATIN (91.34.609.15).



91.30.190

Cr 202.180.03
Ac 202.180.03.AC

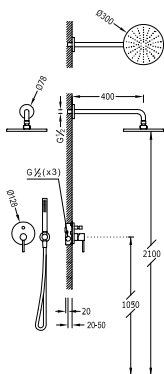

Kit doccia ad incasso STUDY

Con chiusura e regolazione di portata.

- Corpo incassato incluso
- Doccia fissa Ø 300 mm. con snodo. Ottone. (1.34.137.30).
- Supporto per doccia (205.182.01).
- Doccia anticalcare (034.116.01).
- Flessibile satin (91.34.609.15).

Concealed shower set STUDY

with water shut off and flow control.

- Built-in body included
- Fixed shower head Ø 300 mm. with ball joint. Brass. (1.34.137.30).
- Elbow wall (205.182.01).
- Antilime hand shower (034.116.01).
- Shower hose SATIN (91.34.609.15).

Podomítkový jednopákový sprchový set STUDY

s uzávěrem a regulací průtoku.

- Včetně podomítkového tělesa
- Pevná sprcha Ø 300 mm. s kloubem. Materiál mosaz. (1.34.137.30).
- Držák s nástěnným přívodem vody (205.182.01).
- Ruční sprcha, proti usaz. vod. kamene (034.116.01).
- Flexi hadice SATIN (91.34.609.15).



91.30.190

Cr | 262.980.91 |

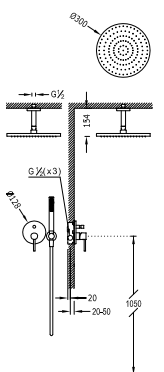

Kit doccia ad incasso

Con chiusura e regolazione di portata.

- Corpo incassato incluso
- Doccia fissa Ø 300 mm. con snodo. Ottone. (1.34.137.30).
- Supporto per doccia (205.182.01).
- Doccia anticalcare (034.116.01).
- Flessibile satin (91.34.609.15).

Concealed shower set

with water shut off and flow control.

- Built-in body included
- Fixed shower head Ø 300 mm. with ball joint. Brass. (1.34.137.30).
- Elbow wall (205.182.01).
- Antilime hand shower (034.116.01).
- Satin hose (91.34.609.15).

Podomítkový jednopákový sprchový set

s uzávěrem a regulací průtoku.

- Včetně podomítkového tělesa
- Pevná sprcha Ø 300 mm. s kloubem. Materiál mosaz. (1.34.137.30).
- Držák s nástěnným přívodem vody (205.182.01).
- Ruční sprcha, proti usaz. vod. kamene (034.116.01).
- Flexi hadice SATIN (91.34.609.15).



91.30.190

Cr | 262.180.80 |





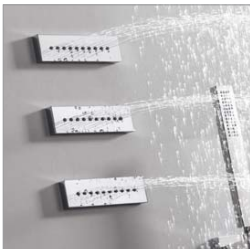

PROGRAMMA PER DOCCE SHOWER PROGRAMME SPRCHOVÝ PROGRAM



Docce da soffitto
Showers head
Stropní sprchy



Asta antiscivolo
Sliding bar
Posuvná tyč



Doccia
Showers
Sprchy



Bocchette
Jets
Stimulační trysky Jets

www.tresgriferia.com



RICAMBI SU
SPARE PARTS AT
NÁHRADNÍ DÍLY NA
www.tresgriferia.com

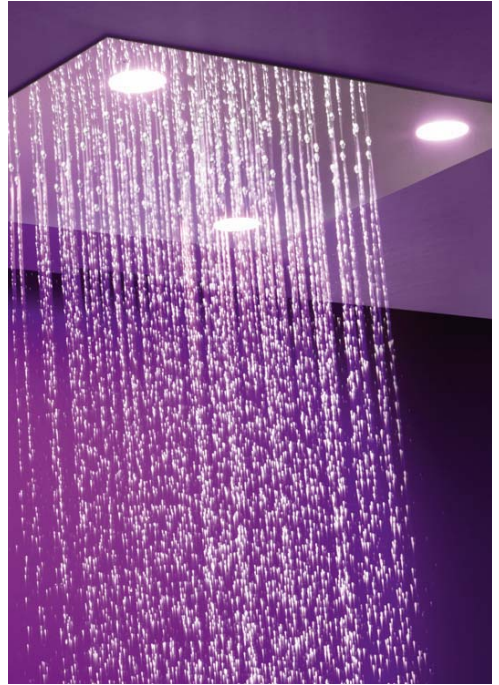



UN'ESPERIENZA NUOVA NELLA DOCCIA A NEW SHOWERING EXPERIENCE NOVÝ ZÁŽITEK ZE SPRCHOVÁNÍ



Soffioni di grande formato Large shower heads Velkoformátové sprchy



Soffioni incassati a soffitto, ultrapiatti. /
Ceiling-mounted, extra flat shower heads.
/ Vestavěná stropní křížka, extrémně
plochá.



Realizzati in acciaio inossidabile. / Made
of stainless steel. / Vyrobená z nerezující
oceli.

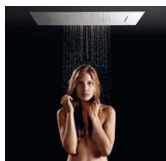

Effetto avvolgente grazie alla distribuzione
di getti e ai limitatori di flusso. / Wraparound
effect, thanks to the jet distribution and
flow rate restrictors. / Obklopující efekt, díky
rozdělení výstupů a omezovačů průtoku.



Ugelli di silicone anticalcare che ne
agevolano la pulizia. / Anti-limescale
silicone nozzles, making them easier to
clean. / Trysky ze silikonu odolného vůči
vodnímu kameni, které usnadňují čištění.



Uscite d'acqua combinate: Pioggia, cascata,
micro drop. / Combined water outlets:
rain shower, waterfall and droplet. /
Kombinované výstupy vody: Déšť, kaskáda,
micro drop.

Tipi di getto Jet types Typy výstupů



Cascata o doppia cascata. / Waterfall or double waterfall /
Kaskáda či dvojitá kaskáda.



Effetto pioggia. / Rain shower effect. / Déšť.



Micro drop.
Spruzza l'acqua sotto forma di gocce minuscole / Disperses
the water in the form of tiny droplets. / Rozprašuje vodu v
podobě mikroskopických kapek.

Cromoterapia
Chromotherapy
Terapie pomocí barev



9 colori con cicli di 2 minuti.
9 colours with 2-minute cycles.
9 barev v cyklech po 2 minutách.



I soffioni TRES Cromoterapia combinano l'acqua con i colori, e offrono il miglior metodo di armonizzazione basato sulle proprietà rivitalizzanti della luce, unite al benessere e al comfort di una bella doccia. / The TRES Chromotherapy shower heads combine water with colours to offer the best harmonisation method using the revitalising properties of light together with the feeling of wellbeing and comfort provided by a shower. / Chromoterapie kryptek společnosti TRES spočívá v kombinaci vody a barev, kryptka nabízí tu nejlepší metodu harmonizace založenou na revitalizačních vlastnostech světla spojených s příjemným pocitem a komfortem, které nám zprostředkovává sprcha.

Attivazione delle luci LED
LED lighting activation
Aktivace osvětlení LED

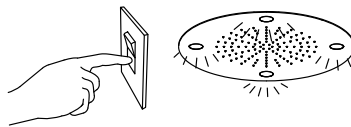
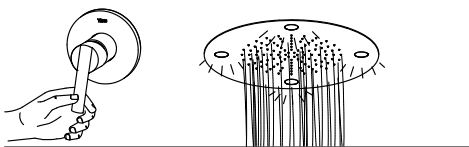

Le luci led si possono attivare in modo automatico. Quando si apre il rubinetto, inizia automaticamente il ciclo di luce. / The led lights can be activated automatically. The light cycle starts automatically when the tap is turned on. / Světla mohou být aktivována automatických způsobem. Při otevření baterie se automaticky spustí světelný cyklus.

Si può attivare anche manualmente se si installa il soffione con questo scopo; il ciclo di luce si attiva tramite un interruttore esterno (non in dotazione) indipendentemente dal fatto che si apra o no il rubinetto. / It can also be activated manually if the shower head for this purpose is installed; the light cycle is activated by an external switch (not supplied), regardless of whether the tap is turned on or not. / Světla je také možno aktivovat manuálně, je-li nainstalováno kryptko k tomuto účelu určené. Světelný cyklus je spuštěn pomocí vypínače (není dodán s baterií) nezávisle na tom, je-li baterie otevřená či nikoliv.

DOCCE DA SOFFITTO / SHOWERS HEAD / STROPNÍ SPRCHY

Ref. / Nr. / Kód:

Soffione doccia acciaio inossidabile anticalcare
2 funzioni (Pioggia/Cascata). 500x800 mm. Alimentazione attraverso 3 vie d'acqua independent.

Steel shower head antilime

2 positions (Rain/Cascade). 500x800 mm. Water supply through 3 independent outlet.

Stropní sprchové křepítko z nerez. oceli, proti usaz. vod. kamene
2 funkce (Děšť/Kakádou). 500x800 mm. Nezávislé třičestné napájení vodo.

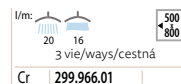
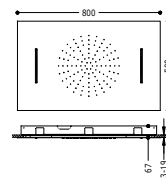
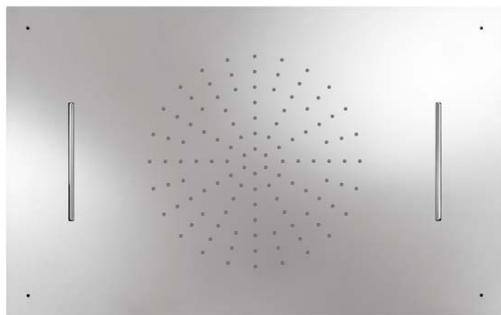

Soffione doccia acciaio inossidabile CHROMOTHERAPY

3 funzioni (Pioggia/Cascata/Chromotherapy). 500x800 mm. Alimentazione attraverso 3 vie d'acqua independent. La luce, una volta collegata alla corrente, si accende al passaggio dell'acqua senza che occorra un interruttore.

Steel shower head CHROMOTHERAPY

3 positions (Rain/Cascade/Chromotherapy). 500x800 mm. Water supply through 3 independent outlet. Once connected to the mains, the light turns on when water passes, without the need for a switch.

Stropní sprchové křepítko z nerez. oceli, CHROMOTHERAPIE

3 funkce (Děšť/Kakádou/Chromotherapie), proti usaz. vod. kamene. 500x800 mm. Nezávislé třičestné napájení vodo. Po připojení elektřiny se světlo rozsvítí bez vypínače spuštěním proudu vody.

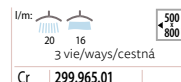
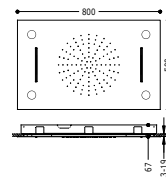
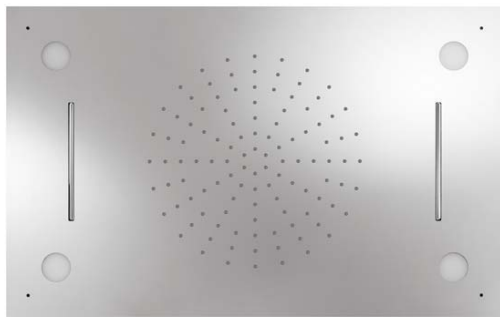

N Soffione doccia acciaio inossidabile anticalcare
2 funzioni (Pioggi/Cascata). 500x650 mm. Alimentazione attraverso 2 vie d'acqua indipendent.

Steel shower head antilime

2 positions (Rain/Cascade). 500x650 mm. Water supply through 2 independent outlet.

Stropní sprchové křepítko z nerez. oceli, proti usaz. vod. kamene
2 funkce (Děšť/Kakádou). 500x650 mm. Nezávislé dwudrožna napájení vodo.

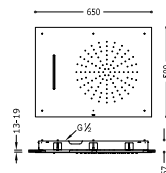
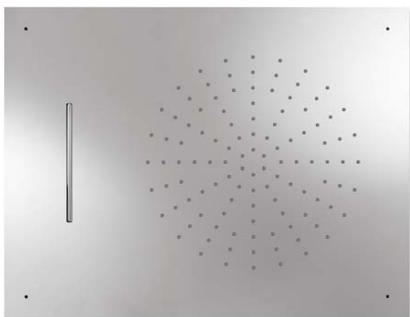

Cr | 299.970.01 |



N Soffione doccia acciaio inossidabile CHROMOTHERAPY
3 funzioni (Pioggi/Cascata/Chromotherapy). 500x650 mm. Alimentazione attraverso 2 vie d'acqua indipendent. La luce, una volta collegata alla corrente, si accende al passaggio dell'acqua senza che occorra un interruttore.

Steel shower head CHROMOTHERAPY

3 positions (Rain/Cascade/Chromotherapy). 500x650 mm. Water supply through 2 independent outlet. Once connected to the mains, the light turns on when water passes, without the need for a switch.

Stropní sprchové křepítko z nerez. oceli, CHROMOTHERAPIE
3 funkce (Děšť/Kakádou/Chromoterapie), proti usaz. vod. kamene. 500x650 mm. Nezávislé dwudrožna napájení vodo. Po připojení elektriny se světlo rozsvítí bez vypínače spuštěním proudu vody.

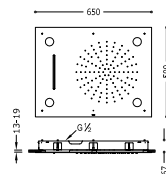
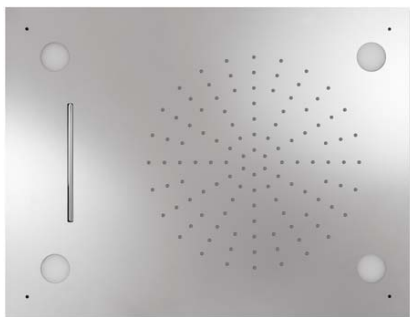

Cr | 299.972.01 |

CHROMOTHERAPY



Cr = Cromo/Chrome/Chrom



Soffione doccia acciaio inossidabile anticalcare

3 funzioni (Pioggi/Cascata/Micro drop). 500x650 mm. Alimentazione attraverso 3 vie d'acqua indipendent.

Steel shower head antilime

3 positions (Rain/Cascade/Micro drop). 500x650 mm. Water supply through 3 independent outlet.

Stropní sprchové křopítko z nerez. oceli, proti usaz. vod. kamene

3 funkce (Děšť/Kakádou/Micro drop), proti usaz. vod. kamene. 500x650 mm. Nezávislé třícestné napájení vodu.

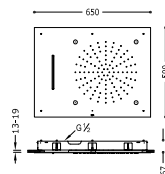
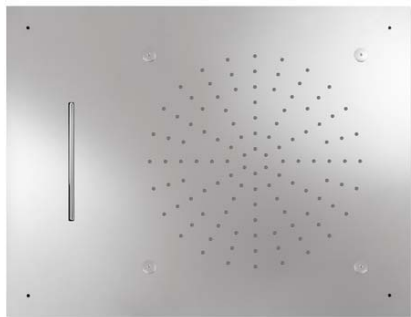

Cr **299.971.01**



Soffione doccia acciaio inossidabile CHROMOTHERAPY

Chromotherapy. 500x500 mm. La luce, una volta collegata alla corrente, si accende al passaggio dell'acqua senza che occorra un interruttore.

Steel shower head CHROMOTHERAPY

Chromotherapy. 500x500 mm. Once connected to the mains, the light turns on when water passes, without the need for a switch.

Stropní sprchové křopítko z nerez. oceli, systém proti usaz. vod. kamene CHROMOTHERAPIE

500x500 mm. Světlo se po připojení elektřiny rozsvítí díky proudu vody, bez vypínače.

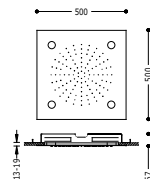
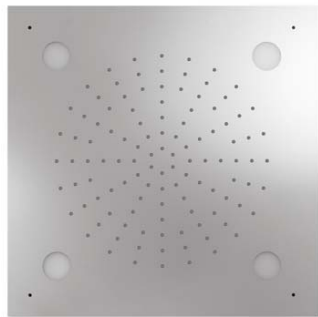

Cr **299.962.01**



Soffione doccia acciaio inossidabile anticalcare
2 funzioni (Poggia/Micro drop). 500x500 mm. Alimentazione attraverso 2 vie d'acqua indipendenti.

Steel shower head antilime

2 positions (Rain/Micro drop). 500x500 mm. Water supply through 2 independent outlets.

Stropní sprchové kropítko z nerez. oceli, proti usaz. vod. kamene
2 funkce (Děšť/Micro drop). 500x500 mm. Nezávislé 2-cestné napájení vodou.

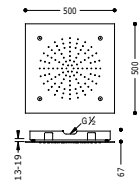
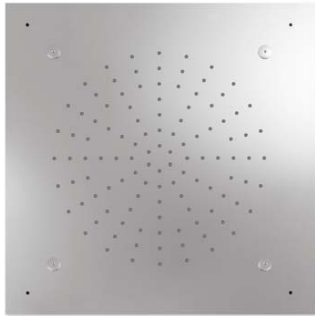

Cr | 299.954.01 |



Soffione doccia acciaio inossidabile anticalcare

Steel shower head antilime

Stropní sprchové kropítko

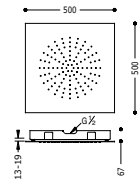
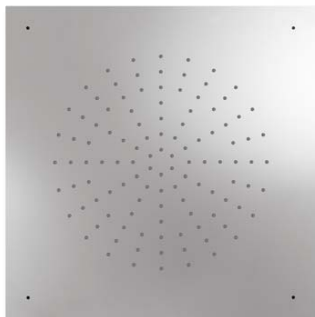

Cr | 299.953.02 |

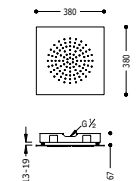

Cr | 299.953.01 |



Soffione doccia acciaio inossidabile LOFT
con cascata. Anticalcare

**Steel shower head antilime LOFT
with cascade**

Stropní sprchové křopítko LOFT
se systémem proti usaz. vod. kamene a vodopádem

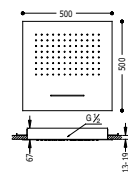
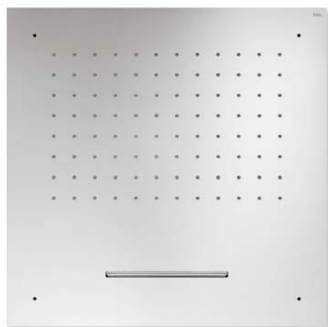

Cr **299.955.01** |



Soffione doccia acciaio inossidabile anticalcare

Steel shower head antilime

Stropní sprchové křopítko

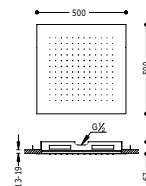
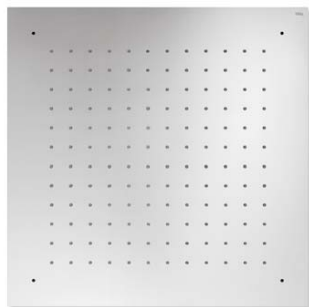

Cr **1.34.951** |

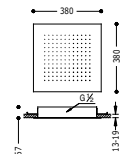

Cr **1.34.944** |



Soffione doccia acciaio inossidabile anticalcare
420x420 mm.

Steel shower head antilime
420x420 mm.

Stropní sprchové kropítko
systém proti usaz. vod. kamene 420x420 mm.

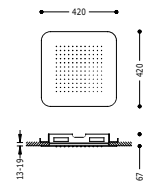

l/m: 20
1 vie./way/cestná

Cr | 299.516.07 |



Docce acciaio inossidabile da parete
con cascata. 152x200 mm.

Steel Wall shower
with cascade. 152x200 mm.

Nástěnné sprchové kropítko
s kaskádou 152x200 mm.

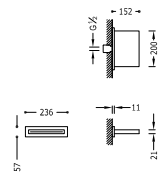

l/m: 16
1 vie./way/cestná

Cr | 299.903.04 |



Soffione doccia acciaio inossidabile anticalcare
2 funzioni (Pioggia/Micro drop). Ø 600 mm. Alimentazione attraverso 2 vie d'acqua indipendenti.

Steel shower head antilime

2 positions (Rain/Micro drop). Ø 600 mm. Water supply through 2 independent outlets.

Stropní sprchové kropítko z nerez. oceli, proti usaz. vod. kamene
2 funkce (Děšť/Micro drop). Ø 600 mm. Nezávislé 2-cestné napájení vodou.

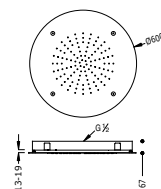
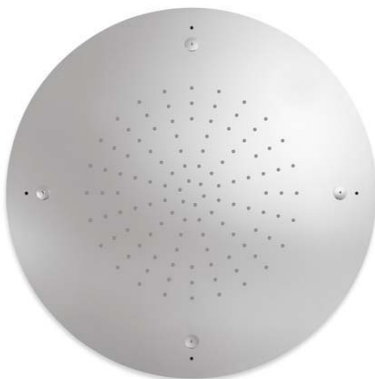

Cr 299.956.01



Soffione doccia acciaio inossidabile CHROMOTHERAPY
2 funzioni (Pioggia/Chromotherapy). Ø 600 mm. Alimentazione attraverso 1 via d'acqua indipendente. La luce, una volta collegata alla corrente, si accende al passaggio dell'acqua senza che occorra un interruttore.

Steel shower head CHROMOTHERAPY

2 positions (Rain/Chromotherapy). Ø 600 mm. Water supply through 1 independent outlet. Once connected to the mains, the light turns on when water passes, without the need for a switch.

Stropní sprchové kropítko z nerez. oceli, CHROMOTHERAPIE
2 funkce (Děšť/Chromotherapie). proti usaz. vod. Kamene. Ø 600 mm. Nezávislé jednocestné napájení vodou. Po připojení elektřiny se světlo rozsvítí bez vypínače spuštěním proudu vody.

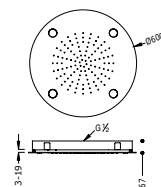

Cr 299.957.01



Soffione doccia acciaio inossidabile CHROMOTHERAPY

3 funzioni (Pioggia/Micro drop/Chromotherapy). Ø 600 mm. Alimentazione attraverso 2 vie d'acqua indipendenti. La luce, una volta collegata alla corrente, si attiva manualmente con un interruttore.

Steel shower head CHROMOTHERAPY

3 positions (Rain/Micro drop/Chromotherapy). Ø 600 mm. Water supply through 2 independent outlets. Once connected to the mains, the light can be turned on and off manually, using the switch.

Stropní sprchové kropítko ocel, systém proti usaz. vod. kamene CHROMOTHERAPY

3 funkce (Děšť/Micro drop/Chromoterapie), proti usaz. vod. kamene. Ø 600 mm. Nezávislé 2-cestné napájení vodou. Elektrická energie a její připojení se ovládá manuálně, prostřednictvím vypínače.

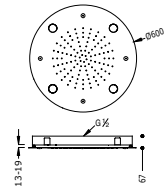

Cr | 299.958.01 |

CHROMOTHERAPY



Soffione doccia acciaio inossidabile anticalcare

Steel shower head antilime

Stropní sprchové kropítko

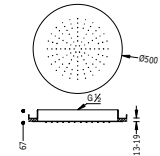
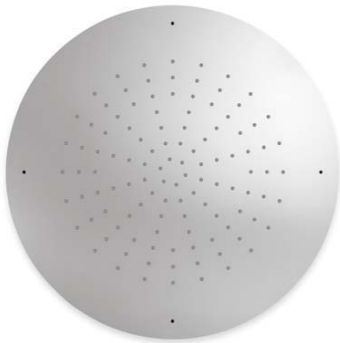

Cr | 1.34.950 |

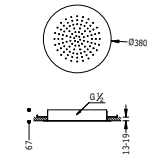

Cr | 1.34.940 |



Docce acciaio inossidabile da parete con cascata. Anticalcare 280x550 mm.

Steel Wall showers antilime with cascade. 280x550 mm.

Nástěnné sprchové křepítko se systémem proti usaz. vod. kamene a vodopádem 280x550 mm.

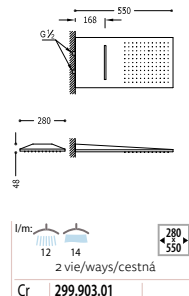

Docce acciaio inossidabile da parete con cascata. Anticalcare 280x550 mm.

Steel Wall showers antilime with cascade. 280x550 mm.

Nástěnné sprchové křepítko se systémem proti usaz. vod. kamene a vodopádem 280x550 mm.

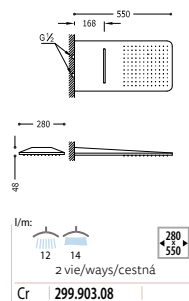

Doccia acciaio inossidabile TRES-CONFORT con cascata. Anticalcare

Steel Wall shower antilime TRES-CONFORT with cascade

Nástěnné sprchové křepítko TRES-CONFORT se systémem proti usaz. vod. kamene a vodopádem

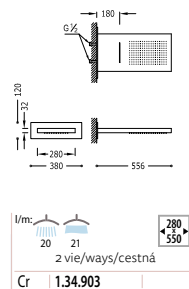

BARRA DI SCORRIMENTO / SLIDING BAR / POSUVNÁ TYČ

Ref. / Nr. / Kód:

Barra di scorrimento con presa d'acqua a parete
Ø 14 mm. Lunga 760 mm.

Sliding bar with wall water intake
Ø 14 mm. Long. 760 mm.

Posuvná tyč s nástěnným přívodem vody
Ø 14 mm. Délka 760 mm.

Barra di scorrimento con presa d'acqua a parete
Ø 14 mm. Lunga 760 mm.

Sliding bar with wall water intake
Ø 14 mm. Long. 760 mm.

Posuvná tyč s nástěnným přívodem vody
Ø 14 mm. Délka 760 mm.

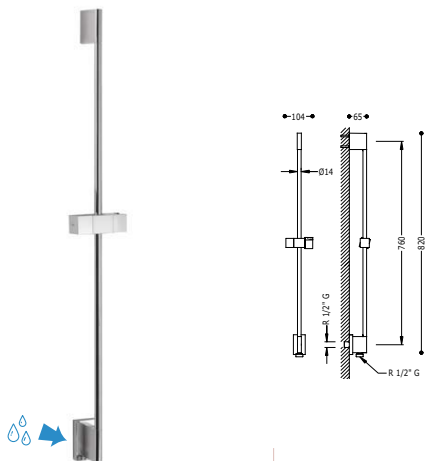

Cr **034.932.99**

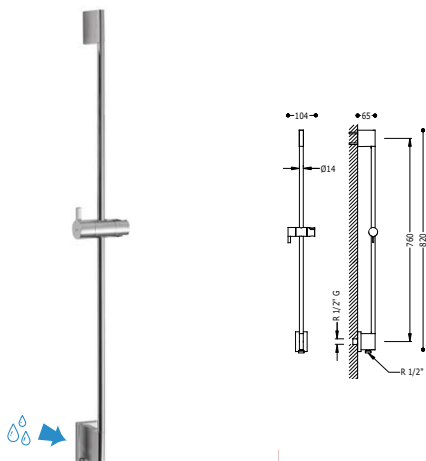

Cr **034.931.99**

Barra di scorrimento con presa d'acqua a parete
Ø 14 mm. Lunga 760 mm. Doccetta anticalcare. (202.639.01). Flessibile satin.

Sliding bar with wall water intake

Ø 14 mm. Long. 760 mm. Antilime hand shower. (202.639.01). Shower hose satin.

Posuvná tyč s nástěnným přívodem vody
Ø 14 mm. Délka 760 mm. Ruční sprcha, proti usaz. vod. kamene (202.639.01). Flexi hadice SATIN.

Barra di scorrimento con presa d'acqua a parete
Ø 14 mm. Lunga 760 mm. Doccetta anticalcare. (034.116.01). Flessibile satin.

Sliding bar with wall water intake

Ø 14 mm. Long. 760 mm. Antilime hand shower. (034.116.01). Shower hose satin.

Posuvná tyč s nástěnným přívodem vody
Ø 14 mm. Délka 760 mm. Ruční sprcha, proti usaz. vod. kamene (034.116.01). Flexi hadice SATIN.

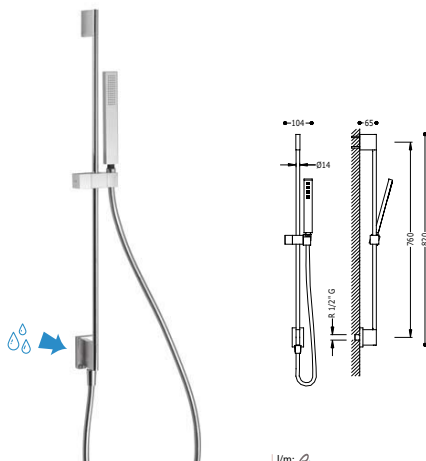

l/m: 9,5

Cr **034.932.01**

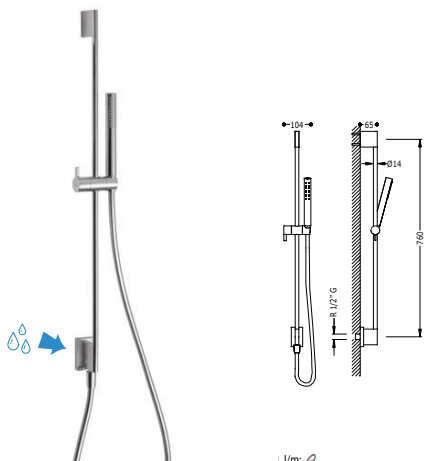

l/m: 9,5

Cr **034.931.01**

DOCCIA / SHOWERS / SPRCHY

Ref. / Nr. / Kód:

Doccetta anticalcare SLIM

Ottone

Antilime shower SLIM

Brass

Sprcha, proti usaz. vod. kamene SLIM

Materiál Mosaz

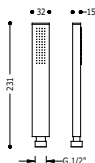

U/m: ρ

9,5

Cr	202.639.01
Ac	202.639.01.AC

Doccetta anticalcare CUADRO

Ottone

Antilime shower CUADRO

Brass

Sprcha, proti usaz. vod. kamene CUADRO

Materiál Mosaz

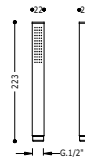

U/m: ρ

9,5

Cr	006.639.01
Ac	006.639.01.AC
	006.639.01.NG
	006.639.01.BL

Doccetta anticalcare LOFT

Antilime shower LOFT

Sprcha, proti usaz. vod. kamene LOFT

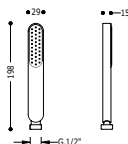

U/m: ρ

13

Cr	034.639.01
Ac	034.639.01.AC
	034.639.01.AM
	034.639.01.NA
	034.639.01.RO
	034.639.01.VI
	034.639.01.FU
	034.639.01.VE
	034.639.01.NE
	034.639.01.BL

Doccetta anticalcare TUB

Ottone

Antilime shower TUB

Brass

Sprcha, proti usaz. vod. kamene TUB

Materiál Mosaz

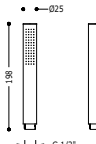

U/m: ρ

9,5

Cr	034.116.01
Ac	034.116.01.AC
	034.116.01.AM
	034.116.01.NA
	034.116.01.RO
	034.116.01.VI
	034.116.01.FU
	034.116.01.VE
	034.116.01.NE
	034.116.01.BL

Doccia massaggio

5 tipi di getto

Massage shower

5 jet types

Masážní sprcha

5 typů proudění vody

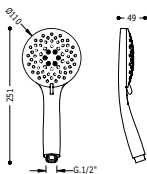

U/m: ρ ρ ρ ρ ρ

10 12,5 12 12,5 10

Cr	299.749.01
----	------------

Doccia massaggio

3 tipi di getto

Massage shower

3 jet types

Masážní sprcha

3 typů proudění vody

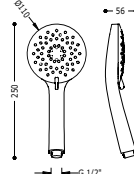

U/m: ρ ρ ρ

12 13 11,5

Cr	299.749.02
----	------------



Doccia massaggio
3 tipi di getto

Massage shower
3 jet types

Masážní sprcha
3 typů proudění vody

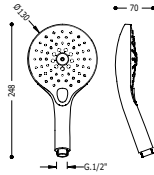

l/m: 7 8 5
Cr | 299.749.03

Doccia massaggio
3 tipi di getto

Massage shower
3 jet types

Masážní sprcha
3 typů proudění vody

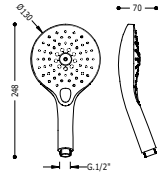

l/m: 7 8 5
Bl-Cr | 299.749.04

Doccia massaggio
3 tipi di getto

Massage shower
3 jet types

Masážní sprcha
3 typů proudění vody



l/m: 8,8 9,6 8,8
Bl-Cr | 299.749.05

Doccia massaggio
3 tipi di getto

Massage shower
3 jet types

Masážní sprcha
3 typů proudění vody

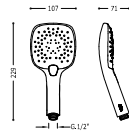

l/m: 8,2 8,6 8,1
Bl-Cr | 299.749.06



BOCCHETTE / JETS / STIMULAČNÍ TRYSKY JETS

Ref. / Nr. / Kód:

3 bocchetta incassate di idromassaggio
140x45 mm.

3 x hydromassage built-in jets
140x45 mm.

3 zapuštěné hydromasážní trysky
140x45 mm.

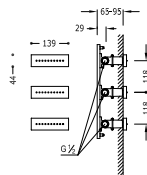

U/m: 7,9
Cr | 299.515.04

3 bocchetta incassate di idromassaggio
140x45 mm.

3 x hydromassage built-in jets
140x45 mm.

3 zapuštěné hydromasážní trysky
140x45 mm.

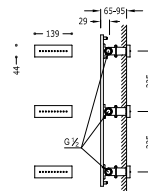

U/m: 7,9
Cr | 299.515.05



3 bocchetta incassate di idromassaggio
80x80 mm.

3 x hydromassage built-in jets
80x80 mm.

3 zapuštěné hydromasážní trysky
80x80 mm.

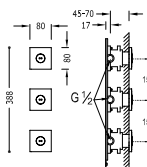

U/m: 10
Cr | 299.515.06

3 bocchetta incassate di idromassaggio
80x80 mm.

3 x hydromassage built-in jets
80x80 mm.

3 zapuštěné hydromasážní trysky
80x80 mm.

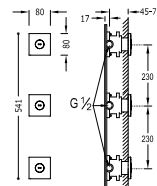

U/m: 10
Cr | 299.515.07



INSTALLAZIONE CONSIGLIATA
INSTALLATION RECOMMENDED
DOPORUČENÁ INSTALACE

REF. 299.515.04
REF. 299.515.06

REF. 299.515.05
REF. 299.515.07

SUPPORTI / SUPPORTS / PODSTAVCE

Ref./Nr./Kód:

Supporto per doccia BLOCK SYSTEM

con presa d'acqua a parete con profondità regolabile e valvola antiritorno. Corpo incassato incluso.

Shower holder BLOCK SYSTEM

with adjustable depth wall water inlet fitting and anti-return valve. Built-in body included

Úchyt ruční sprchy se stěnovou přípojkou vody BLOCK SYSTEM s nastavitelným výstupem pro vodu a zpětným ventilem. Včetně podomítkového tělesa.

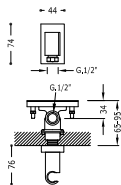

Cr 207.182.02



Supporto per doccia

con presa d'acqua a parete e valvola antiritorno

Shower holder

with wall water outlet and check valve.

Úchyt ruční sprchy se stěnovou přípojkou vody s nastavitelným výstupem pro vodu a zpětným ventilem.

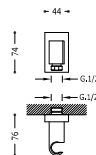

Cr 207.182.01

Supporto per doccia

con presa a parete

Shower holder with wall entrance

Úchyt ruční sprchy se stěnovou přípojkou vody s nástěnným vodním přívodem

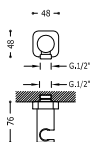

Ac	200.182.01.AC	
	200.182.01.AM	
	200.182.01.NA	
	200.182.01.RO	
	200.182.01.VI	
	200.182.01.FU	
	200.182.01.VE	
	200.182.01.NE	
	200.182.01.BL	

SUPPORTI / SUPPORTS / PODSTAVCE

Supporto orientabile

Ottone

Adjustable holder

Brass

Nastavitelný kulatý držák, kovový

Materiál Mosaz



	061.839.01.AM	
	061.839.01.NA	
	061.839.01.RO	
	061.839.01.VI	
	061.839.01.FU	
	061.839.01.VE	
	061.839.01.NE	
	061.839.01.BL	



SPAZIO DOCCIA SPAZIO VASCA SHOWER SPACE BATH SPACE SPRCHOVÝ PROSTOR VANOVÝ PROSTOR



Termostatiche
Thermostatic
Termostatické

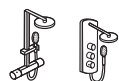

Gruppi termostatici
Termostatické soupravy
Thermostatically-controlled sets



Monocomandi
Mixer taps
Baterie



Programma per docce
Bath space
Vanový prostor

www.tresgriferia.com



RICAMBI SU
SPARE PARTS AT
NÁHRADNÍ DÍLY NA
www.tresgriferia.com

GRUPPI TERMOSTATICI DI ULTIMA GENERAZIONE LATEST-GENERATION THERMOSTAT TERMOSTATICKÉ SPRCHY POSLEDNÍ GENERACE

Confronto tra i gruppi termostatici tradizionali e i gruppi termostatici con il sistema touch-cool®
Comparison between a conventional thermostatic tap and a thermostatic tap with the touch-cool® system.
Srovnání běžné termostatické baterie a termostatické baterie vybavené systémem touch-cool®.



Gruppi termostatici tradizionali. La cartuccia si trova nella manopola destra. Il circuito interno dell'acqua fa in modo che l'acqua calda tocchi la superficie e riscaldi il rubinetto.

Conventional thermostatic tap. The cartridge is inside the right control. The internal water circuit makes the hot water come in contact with the surface, heating up the tap.

Běžná termostatická. Kartuš je umístěna v pravém kotouči. Vnitřní vodní okruh způsobí kontakt mezi horkou vodou a povrchem a ohřívá baterii.



Gruppi termostatici con sistema touch-cool®. La cartuccia si trova nella manopola sinistra. Il circuito interno dell'acqua fa in modo che sia l'acqua fredda a toccare la superficie e in questo modo il rubinetto rimane sempre freddo al tatto, evitando bruciature.

Thermostatic tap with the touch-cool® system. The cartridge is inside the left control. The internal water circuit makes the cold water come in contact with the surface, meaning the tap stays cool when touched and preventing burns.

Termostatická se systémem touch-cool®. Kartuš je umístěna v levém kotouči. Vnitřní oběh vody způsobí kontakt mezi studenou vodou a povrchem, díky čemuž zůstává baterie vždy chladná na dotek a nedochází k popálením.

La rubinetteria termostatica TRES fornisce subito acqua a temperatura costante permettendo, in tal modo, di ridurre il consumo di energia e di acqua. Incorpora il sistema antiscottature touch-cool® (la rubinetteria con questo sistema viene indicata con il simbolo corrispondente). / TRES thermostatically-controlled tapware provides constant water temperature in the shortest possible time, saving both energy and water. It incorporates the TRESTOUCH-COOL® anti-scalding system (the tapware with this system is marked with the corresponding symbol). / Termostatické baterie TRES udržují stálou teplotu vody v minimálně krátké době, čímž snižují její spotřebu a také spotřebu energie. Mají také zabudovaný systém proti opáření touch-cool® (baterie s tímto systémem jsou uvedeny pod odpovídajícím symbolem).



Vantaggi
Advantages
Výhody



Deviatore integrato nella manopola è presente un regolatore di flusso, sia per 2 che per 3 vie. / **Inverter built into the flow rate regulator control (for 2 and 3 outlets).** / Invertor zabudovaný v kotočiči pro regulaci průtoku, jak pro 2 přívody, tak i pro 3.



Raccordi eccentrici con silenziatore e filtro. Evita l'entrata di sporcizia, che si traduce in meno guasti e una vita utile più prolungata. / **Eccentrics fitted with a silencer and filter. This prevents dirt from entering, reducing failures and ensuring a longer life.** / Excentrické s tlumičem hluku a filtrem. Zabraňujú prístupu nečistot, čo znamená méné poruch a delší životnosť.



Cartuccia deviatrice con tre funzioni: rubinetto di chiusura, deviatore e regolatore di flusso. / **Distribution cartridge with three functions: stopcock, inverter and flow rate regulator.** / Distribuční kartuše se třemi funkcemi: zavírací ventil, invertor a regulátor průtoku.



Controllo della temperatura. Con pulsante di sicurezza che limita la temperatura a 38 °C. / **Temperature control. With a safety pushbutton that limits the temperature to 38°C.** / Nastavení teploty. S bezpečnostním tlačítkem, který omezuje teplotu na 38 °C.



Affidabilità della cartuccia essendo un elemento totalmente anticalcare, non ne permette l'accumulo. / **Reliable cartridge which has is a completely anti-limescale body, making it resistant to limescale build-up.** / Spolehlivost kartuše vzhledem ke svému speciálnímu ošetření je zcela odolná vůči usazeninám vodního kamene.

Confronto di cartucce (intercambiabili)
Comparison of cartridges (interchangeable)
Srovnání kartuší tj. nábojů (vzájemně zaměnitelných)



Instant 57®   

Cartuccia difficilmente ostruibile, alta durabilità e con protezione anticalcare. / **Extremely durable obstruction-proof cartridge with anti-limescale protection.** / Kartuše se nezanáší, má dlouhou životnost a je odolná vůči usazeninám vodního kamene.

Portata/Flow rate/Průtok: 50-55 l/m



Instant 77®   

La cartuccia assicura una portata d'acqua costante alla temperatura desiderata di ± 1 grado in caso di variazioni di pressione e/o temperatura. Concepita per la disinfezione dalla legionella. / **The cartridge ensures a constant flow of water at the desired temperature ± 1 degree, in spite of pressure and/or temperature changes. Designed for Legionella disinfection.** / Kartuše zaručuje stálý průtok vody zvolené teploty, ± 1 stupeň, v závislosti na změně tlaku a/nebo teploty. Vhodné k dezinfekci legionely.

Portata/Flow rate/Průtok: 30-35 l/m

I simboli indicano, in ciascun prodotto, la tecnologia che utilizza la cartuccia in ciascun gruppo termostatico. / The symbols show, for each reference, the cartridge technology used in each thermostatic tap. / Symboly indikují jednotlivé technologie použité u kartuší termostatických baterií.

Pulizia facile della cartuccia
Easy to clean cartridge
Snadné čištění kartuše

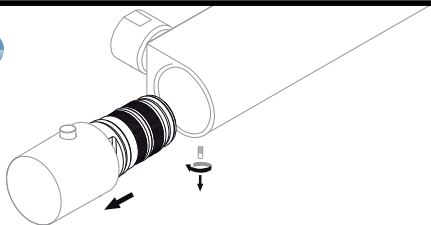

Con la tecnologia easy clean®, TRES offre la possibilità di pulire la cartuccia termostatica in caso di malfunzionamento od ostruzione facilitandone il montaggio e smontaggio. / **Through the easy clean® technology, TRES makes it possible to clean the cartridge if it is blocked or not working properly, facilitating the assembly and disassembly of the thermostatic cartridge.** / Technologie easy clean®, nabízí možnost čištění kartuše v případě jejího špatného fungování či ucpání, a také usnadňuje její montáž a demontáž.

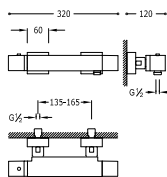

Doccia CUADRO termostatica
(Doccetta anticalcare (006.639.01) con supporto orientabile. Flessio satinato (91.34.609.15)).

Wall thermostatic shower mixer CUADRO
(Anti-limescale hand shower (006.639.01) with directable support. Shower hose satin (91.34.609.15)).

Termostatická sprchová baterie CUADRO
(Ruční sprcha (006.639.01) s nastavitelným držákem, proti usaz. vod. kamene. Flexi hadice SATIN (91.34.609.15))

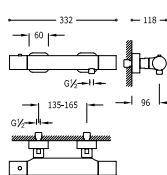

Doccia LOFT termostatica
(Doccetta anticalcare (034.639.01) con supporto orientabile. Flessibile satin (91.34.609.15)).

Wall thermostatic shower mixer LOFT
(Anti-limescale hand shower (034.639.01) with directable support. Shower hose satin (91.34.609.15)).

Termostatická sprchová baterie LOFT
(Ruční sprcha (034.639.01) s nastavitelným držákem, proti usaz. vod. kamene (034.639.01) a flexi hadice SATIN (91.34.609.15))

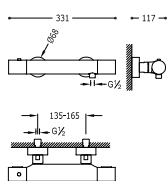

Doccia MAX termostatica
(Doccetta anticalcare con supporto orientabile. Flessibile satin (91.34.609.15)).

Wall thermostatic shower mixer MAX
(Anti-limescale hand shower with directable support and satin hose (91.34.609.15)).

Termostatická sprchová baterie MAX
(Ruční sprcha s nastavitelným držákem, proti usaz. vod. kamene a flexi hadice SATIN (91.34.609.15))

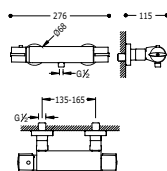

Doccia LEX/ALPLUS termostatica
(Doccetta Ø 100 mm. (5 funzioni) (1.34.748) con supporto orientabile e flessibile satin (91.34.609.15)).

Wall thermostatic shower mixer LEX/ALPLUS
(Massage hand shower Ø 100 mm. (5 fonctions) (1.34.748) with directable support and satin hose (91.34.609.15)).

Termostatická sprchová baterie LEX/ALPLUS
(Ruční masážní sprcha Ø 100 mm. (5 funkcí) (1.34.748) s nastavitelným držákem. Flexi hadice SATIN (91.34.609.15))



Doccia ECO-TERM termostatica
(Doccetta anticalcare (91.34.725) con supporto orientabile.
Flessibile satin (91.34.609.15)).



ECO-TERM

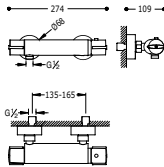

Wall thermostatic shower mixer ECO-TERM
(Anti-limescale hand shower (91.34.725) with directable support. Shower hose satin (91.34.609.15)).

Termostatická sprchová baterie ECO-TERM
(Ruční sprcha (91.34.725) s nastavitelným držákem, proti usaz. vod. kamene a flexi hadice SATIN (91.34.609.15)).



ECO-TERM
Cr 299.195.04
1.90.186



ECO-TERM
Cr 299.195.04
090.186.01



Doccia FLAT termostatica
(Doccetta anticalcare (1.34.617) con supporto orientabile.
Flessibile doppia graffatura (91.34.828)).



FLAT

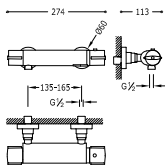

Wall thermostatic shower mixer FLAT
(Anti-limescale hand shower (1.34.617) with directable support. Double interlocked shower hose (91.34.828)).

Termostatická sprchová baterie FLAT
(Ruční sprcha (1.34.617) s nastavitelným držákem, proti usaz. vod. kamene a flexi hadice s dvojitým zámkem (91.34.828)).



FLAT
Cr 299.195.08
204.196.01



FLAT
Cr 299.195.08
204.196.03



Doccia BASIC termostatica
(Doccetta anticalcare (1.34.821) con supporto orientabile.
Flessibile satin (91.34.609.15)).



BASIC

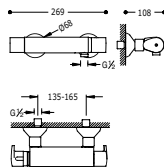

Wall thermostatic shower mixer BASIC
(Anti-limescale hand shower (1.34.821) with directable support. Shower hose satin (91.34.609.15)).

Termostatická sprchová baterie BASIC
(Ruční sprcha (1.34.821) s nastavitelným držákem, proti usaz. vod. kamene a flexi hadice SATIN (91.34.609.15)).



BASIC
Cr 91.94.172
1.90.162



BASIC
Cr 91.94.172
1.90.162.9



Doccia termostatica
(Doccetta anticalcare (299.631.03) con supporto orientabile.
Flessibile satin (91.34.609.15). Indicato per persone con disabilità fisiche

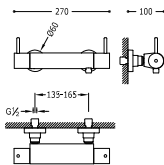

Wall thermostatic shower mixer
Anti-limescale hand shower (299.631.03) with directable support. Shower hose satin (91.34.609.15). Suitable for persons with physical disabilities.

Termostatická sprchová baterie
Ruční sprcha s nastavitelným držákem (299.631.03), proti usaz. vod. kamene a flexi hadice SATIN (91.34.609.15). Určeno pro osoby s fyzickým handicapem



299.195.09
Cr **090.264.01**



299.195.09
Cr **090.964.01**





CUADRO

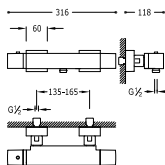

Vasca-Doccia CUADRO termostatica

Con bocca a cascata (Doccetta anticalcare (006.639.01) con supporto orientabile. Flessibile satinato (91.34.609)).

Wall thermostatic bath and shower mixer CUADRO with cascade (Anti-limescale hand shower (006.639.01) with directable support. Shower hose satin (91.34.609)).

Termostatická baterie pro vanu-sprchu CUADRO s kaskádou (Ruční sprcha (006.639.01) s nastavitelným držákem, proti usaz. vod. kamene. Flexi hadice SATIN (91.34.609))



LOFT

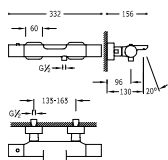

Vasca-Doccia LOFT termostatica

Con bocca a cascata (Doccetta anticalcare (034.639.01) con supporto orientabile. Flessibile satin (91.34.609)).

Wall thermostatic bath and shower mixer LOFT with cascade (Anti-limescale hand shower (034.639.01) with directable support. Shower hose satin (91.34.609)).

Termostatická baterie pro vanu-sprchu LOFT s kaskádou (Ruční sprcha (034.639.01) s nastavitelným držákem, proti usaz. vod. kamene a flexi hadice SATIN (91.34.609)).

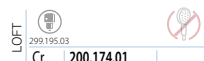

CLASS

MAX

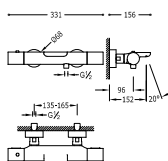

Vasca-Doccia MAX termostatica

Con bocca a cascata (Doccetta anticalcare con supporto orientabile. Flessibile satin (91.34.609)).

Wall thermostatic bath and shower mixer MAX with cascade (Anti-limescale hand shower with directable support. Shower hose satin (91.34.609)).

Termostatická baterie pro vanu-sprchu MAX s kaskádou (Ruční sprcha s nastavitelným držákem, proti usaz. vod. kamene a flexi hadice SATIN (91.34.609)).



LEX/ALPLUS

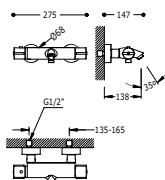

Vasca-Doccia LEX/ALPLUS termostatica

(Doccetta Ø 100 mm. (5 funzioni) (1.34.748) con supporto orientabile. Flessibile satin (91.34.609)).

Wall thermostatic bath and shower mixer LEX/APLUS (Massage hand shower Ø 100 mm. (5 funzioni) (1.34.748) with directable support. Shower hose satin (91.34.609)).

Termostatická baterie pro vanu-sprchu LEX/ALPLUS (Ruční masážní sprcha Ø 100 mm. (5 funkcí) (1.34.748) s nastavitelným držákem, proti usaz. vod. kamene. Flexi hadice SATIN (91.34.609))





BASIC

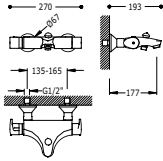

Vasca-Doccia BASIC termostatica
(Doccetta anticalcare (1.34.821) con supporto orientabile.
Flessibile satin (91.34.609)).

Wall thermostatic bath and shower mixer BASIC
(Anti-limescale hand shower (1.34.821) with directable support.
Shower hose satin (91.34.609)).

Termostatická baterie pro vanu-sprchu BASIC
(Ruční sprcha (91.34.725) s nastavitelným držákem, proti usaz.
vod. kamene a flexi hadice SATIN (91.34.609))



BASIC
91.34.172
Cr | **1.90.172**

BASIC
91.34.172
Cr | **1.90.172.9**

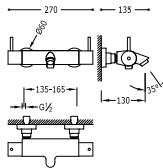

Vasca-Doccia termostatica

Doccetta anticalcare (299.631.03) con supporto orientabile.
Flessibile satin (91.34.609). Indicato per persone con disabilità
fisiche

Wall thermostatic shower mixer
Anti-limescale hand shower (299.631.03) with directable
support. Shower hose satin (91.34.609). Suitable for persons
with physical disabilities.

Termostatická baterie pro vanu-sprchu
Ruční sprcha (299.631.03) s nastavitelným držákem, proti usaz.
vod. kamene a flexi hadice SATIN (91.34.609)). Určeno pro osoby
s fyzickým handicapem



299.195.09
Cr | **090.274.01**

299.195.09
Cr | **090.974.01**

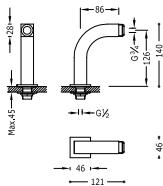

Gomito adattatore bagno-doccia
2 unità con silenziatore

Shower-bath elbow adaptor
2 units with silencer

Rohový ventil vana-sprcha
2 kusy s tlumičem

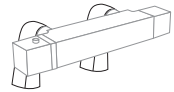

Cr | **299.870.02**

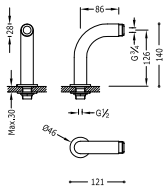

Gomito adattatore bagno-doccia
2 unità con silenziatore

Shower-bath elbow adaptor
2 units with silencer

Rohový ventil vana-sprcha
2 kusy s tlumičem

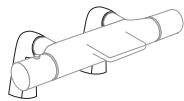

Cr | **299.870.01**

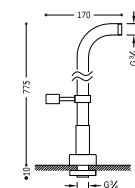

Prese d'acqua a terra per vasca da bagno
2 unità con supporto doccia girevole

Water intake at floor of bath
2 units with adjustable shower support

Vodovodní přípojky na okraj vany
2 kusy s otočným sprchovým držákem

Cr | **1.61.194**











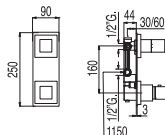
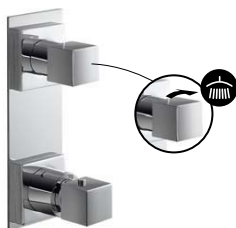



TERMOSTATICA AD INCASSO / CONCEALED THERMOSTATIC MIXER / PODOMÍTKOVÁ TERMOSTATICKÁ BATERIE

Ref. / Nr. / Kód:

Termostatica ad incasso BLOCK SYSTEM (1 via)
 Concealed thermostatic mixer BLOCK SYSTEM (1 way)
 Termostatická (1-cestné) baterie podomítková
 BLOCK SYSTEM

1 VIA / WAY / CESTNÉ



QUADRO/SLIM	 299.250.55	 BELARUSA	
Cr	1.07.250		
MAX	 299.250.55		
Cr	061.250.01		
LOFT	 299.250.55	 BELARUSA	
Cr	200.250.01		
BIMAX	 299.250.55	 BELARUSA	
Cr	1.63.250		



2 VIE / WAYS / CESTNÁ

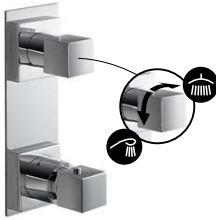

Termostatica ad incasso BLOCK SYSTEM (2 vie)
Concealed thermostatic mixer BLOCK SYSTEM (2 ways)
Termostatická (2-cestná) baterie podomítková
BLOCK SYSTEM

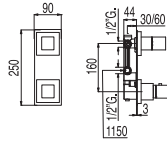

	299.250.55	REGOLABILA	
Cr	1.07.251		
	299.250.55	REGOLABILA	
Cr	200.250.02		
	299.250.55	REGOLABILA	
Cr	1.63.251		
	299.250.55		
Cr	061.250.02		
	299.250.55	REGOLABILA	
Cr	1.81.251		

3 VIE / WAYS / CESTNÁ

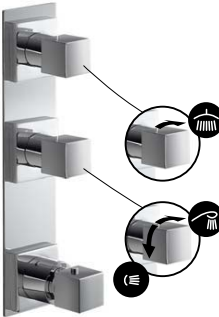

Termostatica ad incasso BLOCK SYSTEM (3 vie)
Concealed thermostatic mixer BLOCK SYSTEM (3 ways)
Termostatická (3-cestná) baterie podomítková
BLOCK SYSTEM

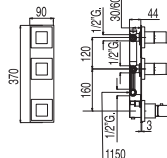

	299.250.55	REGOLABILA	
Cr	1.07.252		
	299.250.55		
Cr	061.250.03		
	299.250.55	REGOLABILA	
Cr	200.250.03		
	299.250.55	REGOLABILA	
Cr	1.63.252		

4 VIE / WAYS / CESTNÁ

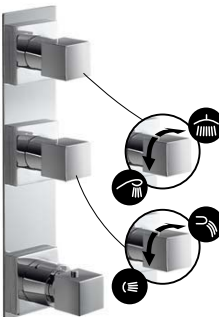

Termostatica ad incasso BLOCK SYSTEM (4 vie)
Concealed thermostatic mixer BLOCK SYSTEM (4 ways)
Termostatická (4-cestná) baterie podomítková
BLOCK SYSTEM

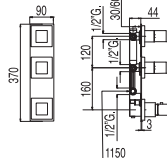

	299.250.55	REGOLABILA	
Cr	1.07.253		
	299.250.55		
Cr	061.250.04		
	299.250.55	REGOLABILA	
Cr	200.250.04		
	299.250.55	REGOLABILA	
Cr	1.63.253		

GRUPPI TERMOSTATICI DA INCASSO A DESIGN COMPATTO
BUILT-IN THERMOSTATIC TAP WITH A COMPACT DESIGN
VESTAVĚNÁ TERMOSTATICKÁ BATERIE S KOMPAKTNÍM DESIGNEM

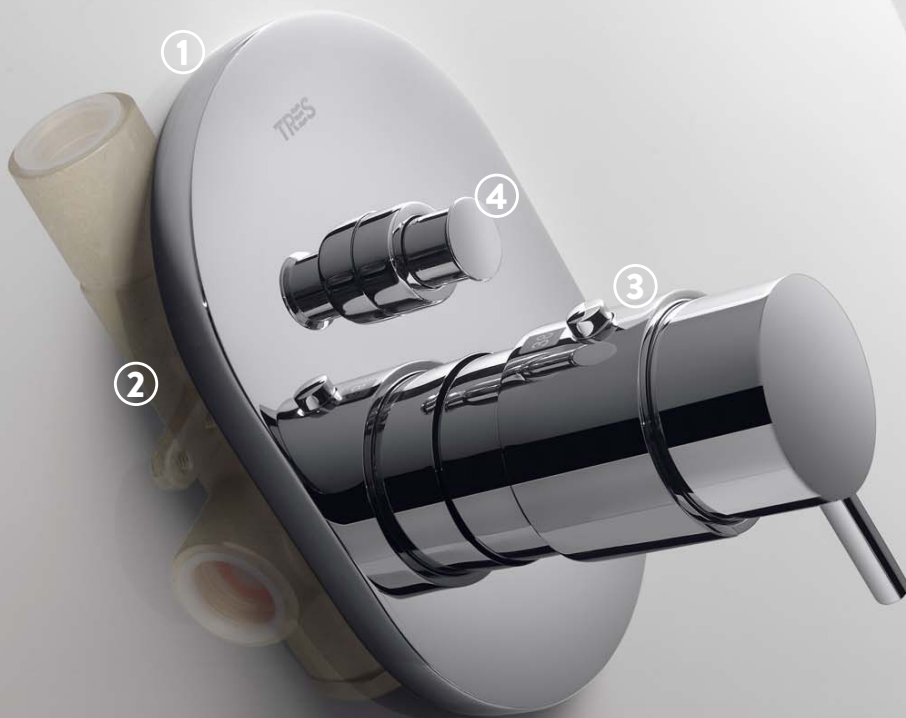

1

Facile montaggio. Senza viti a vista. Installazione ottimale per tramezzi in cartongesso e in muratura. / Easy to install. No visible screws. Optimal installation for plasterboard and brick partition walls. / Snadná montáž. Bez patrných šroubů. Instalace optimální pro stěny z cihel a sádkkartonu.

3

Controllo della temperatura. Con pulsante di sicurezza che limita la temperatura a 38 °C. / Temperature control. With a safety pushbutton that limits the temperature to 38°C. / Nastavení teploty. S bezpečnostním tlačítkem, které omezuje teplotu na 38 °C.

2

Incasso regolabile. Tra 20-50 o 60 mm di corpo ad incasso. Occorrono soltanto 60 mm di profondità. / Adjustable recessing. Recessed body between 20-50 or 60 mm. Only 60 mm of depth is required. / Nastavitelná hloubka vestavění. Mezi 20-50 či 60 mm vestavění. Potřebujete pouhých 60 mm do hloubky.

4

Deviatore integrato. Devia l'uscita dell'acqua tra la doccia a mano e la doccia a parete o attiva la doppia funzione del soffione. / Built-in inverter. Switches the water flow from the hand shower to the wall shower or activates the double shower head function. / Zabudovaný invertor. Přepíná proud vody mezi ruční a nástěnnou sprchou nebo aktivuje dvojitou funkci křovítka.

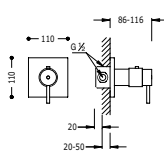

Termostatica ad incasso doccia
Con chiusura e regolazione di portata
- Corpo incassato incluso

Concealed thermostatic mixer. Single lever shower mixer with water shut off and flow control.
- Built-in body included

Termostatická sprchová baterie podomítková
s uzávěrem a regulací průtoku
- Včetně podomítkového tělesa

91.04.552
Cr | **1.90.647**

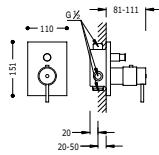

Termostatica ad incasso vasca
Con chiusura e regolazione di portata
- Corpo incassato incluso

Concealed thermostatic mixer. Single lever bath and shower mixer with water shut off and flow control.
- Built-in body included

Termostatická baterie pro vanu-sprchu podomítková
s uzávěrem a regulací průtoku
- Včetně podomítkového tělesa

91.04.552
Cr | **1.90.652**

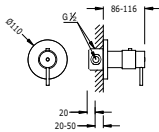

Termostatica ad incasso doccia
Con chiusura e regolazione di portata
- Corpo incassato incluso

Concealed thermostatic mixer. Single lever shower mixer with water shut off and flow control.
- Built-in body included

Termostatická sprchová baterie podomítková
s uzávěrem a regulací průtoku
- Včetně podomítkového tělesa

91.04.552
Cr | **1.90.547**

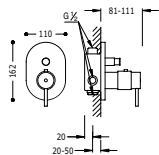

Termostatica ad incasso vasca
Con chiusura e regolazione di portata
- Corpo incassato incluso

Concealed thermostatic mixer. Single lever bath and shower mixer with water shut off and flow control.
- Built-in body included

Termostatická baterie pro vanu-sprchu podomítková
s uzávěrem a regulací průtoku
- Včetně podomítkového tělesa

91.04.552
Cr | **1.90.552**

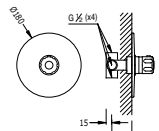

Termostatica ad incasso doccia
Uscita da 1/2" Importante: si deve aggiungere rubinetto di arresto per la chiusura e regolazione di caudal.
- Corpo incassato incluso

Concealed thermostatic mixer. Single lever shower mixer 1/2" outlet Important: You must also place gate valves to close the water supply and control flow.
- Built-in body included

Termostatická sprchová baterie podomítková
Výstupy 1/2". Důležité
- Včetně podomítkového tělesa

91.04.290
Cr | **1.90.165**

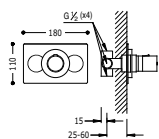

Termostatica ad incasso doccia
Importante: Si deve aggiungere il rubinetto/i di arresto per la chiusura e regolazione di portata.
- Corpo incassato incluso

Concealed thermostatic mixer. Single lever shower mixer Important: You must also place gate valves to close the water supply and control flow.
- Built-in body included

Termostatická sprchová baterie podomítková
Důležité
- Včetně podomítkového tělesa

91.04.161
Cr | **1.90.150**

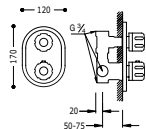

Termostatica ad incasso con rubinetto di arresto

- Uscita da 3/4. Grande portata acqua
- Corpo incassato incluso

Concealed thermostatic shower mixer with gate-valve

- 3/4" outlet
- Built-in body included

Termostatická baterie podomítková s uzavíracím ventilem

- Výstupy 3/4". Silný průtok
- Včetně podomítkového tělesa



91.94.290
Cr 1.90.151

N

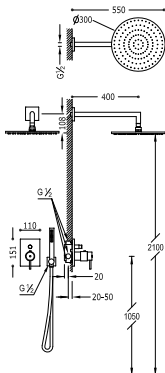

Kit termostatico doccia ad incasso

- con chiusura e regolazione di portata (2 vie).
- Corpo incassato incluso
- Doccia fissa Ø 300 mm. con snodo. Ottone (1.34.137.30).
- Supporto per doccia (205.182.01).
- Doccetta anticalcare (034.116.01).
- Flessibile satin (91.34.609.15).

Concealed thermostatic shower kit

- with water shut off and flow control (2 ways).
- Built-in body included
- Fixed shower head Ø 300 mm. with ball joint. Brass (1.34.137.30).
- Elbow wall (205.182.01).
- Antilime hand shower (034.116.01).
- Satin hose (91.34.609.15).

Podomítkový sprchový set termostatické baterie

- s uzavěrem a regulací průtoku (2-cestná).
- Včetně podomítkového tělesa
- Pevná sprcha Ø 300 mm. s kloubem. Materiál mosaz (1.34.137.30).
- Držák s nástěnným přívodem vody (205.182.01).
- Ruční sprcha, proti usaz. vod. kamene (034.116.01).
- Flexi hadice SATIN (91.34.609.15).



91.94.552
Cr 090.960.02

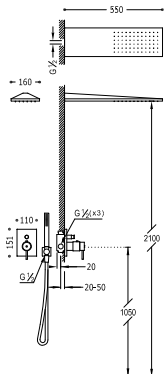

Kit termostatico doccia ad incasso

- con chiusura e regolazione di portata (2 vie).
- Corpo incassato incluso
- Doccia acciaio inossidabile da parete 160x550 mm. (299.903.03).
- Supporto per doccia (205.182.01).
- Doccetta anticalcare (034.116.01).
- Flessibile satin (91.34.609.15).

Concealed thermostatic shower kit

- with water shut off and flow control (2 ways).
- Built-in body included
- Stainless steel wall shower 160x550 mm. (299.903.03).
- Elbow wall (205.182.01).
- Antilime hand shower (034.116.01).
- Satin hose (91.34.609.15).

Podomítkový sprchový set termostatické baterie

- s uzavěrem a regulací průtoku (2-cestná).
- Včetně podomítkového tělesa
- Nástěnné sprchové křepitko z nerez. oceli 160x550 mm. (299.903.03).
- Držák s nástěnným přívodem vody (205.182.01).
- Ruční sprcha, proti usaz. vod. kamene (034.116.01).
- Flexi hadice SATIN (91.34.609.15).



91.94.552
Cr 090.960.01

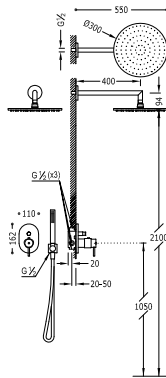

Kit termostatico doccia ad incasso

con chiusura e regolazione di portata (2 vie).

- Corpo incassato incluso
- Doccia fissa Ø 300 mm. con snodo. Ottone (1.34.137.30).
- Supporto per doccia (205.182.01).
- Doccetta anticalcare (034.116.01).
- Flessibile satin (91.34.609.15).

Concealed thermostatic shower kit

with water shut off and flow control (2 ways).

- Built-in body included
- Fixed shower head Ø 300 mm. with ball joint. Brass (1.34.137.30).
- Elbow wall (205.182.01).
- Antilime hand shower (034.116.01).
- Satin hose (91.34.609.15).

Podomítkový sprchový set termostatické bateri

s uzávěrem a regulací průtoku (2-cestná).

- Včetně podomítkového tělesa
- Pevná sprcha Ø 300 mm. s kloubem. Materiál mosaz (1.34.137.30).
- Držák s nástěnným přívodem vody (205.182.01).
- Ruční sprcha, proti usaz. vod. kamene (034.116.01).
- Flexi hadice SATIN (91.34.609.15).





Accensione, pausa e spegnimento

On, pause and off

Zapnutí, pauza a vypnutí



Controllo del flusso

Flow control

Ovládání průtoku



Uscita acqua (soffione o doccia)

Water outlet (sprinkler or shower)

Výstup vody (kropítko nebo sprcha)



Controllo della temperatura

Temperature control

Ovládání teploty

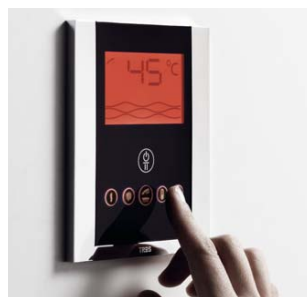

Pannello termostatico elettronico / Electronic thermostatic control panel / Elektronický termostatický panel

- Il sistema di doccia digitale prevede 5 livelli di flusso (quantità d'acqua) e controlla la temperatura tra i 25°C e i 46°C.
- Il miscelatore digitale si spegnerà automaticamente quando il prodotto resta aperto per più di 15 minuti.
- In caso di eventuali errori di alimentazione dell'acqua fredda, il sistema si blocca e interrompe il flusso di acqua. Sistema antiscottature, ideale per bambini e anziani.
- The digital shower system provides 5 flow levels (regulating the amount of water) and temperature control between 25°C and 46°C.
- The digital mixer tap shuts off automatically when the water has been flowing continuously for more than 15 minutes.
- In the event of malfunction in the hot or cold water supply, the system locks and the flow of water shuts off. Anti-scalding system, ideal for children and the elderly.
- V systému digitální sprchy je zabudováno 5 stupňů průtoku (množství vody) a teplotu lze nastavit od 25°C do 46°C.
- Je-li sprcha nepřetržitě puštěná déle než 15 minut, digitální směšovač se automaticky vypne.
- V případě poruch dodávek studené vody se zařízení zablokuje a průtok vody se zastaví. Systém proti opaření, ideální pro děti a osoby vyššího věku.

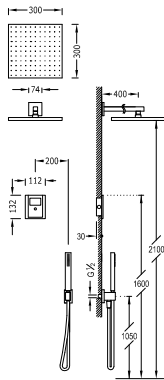

Kit elettronico per doccia termostatico da incasso
SHOWER TECHNOLOGY

- Centralina termostatica elettronica inclusa (2 vie).
- Doccia fissa 300x300 mm. con snodo. Ottone (1.34.138.30).
- Supporto per doccia (006.182.01).
- Doccetta anticalcare (202.639.01).
- Flessibile satin (91.34.609.15).

Built-in electronic thermostatic shower kit
SHOWER TECHNOLOGY

- Electronic thermostatic control box included (2 ways).
- Fixed shower head 300x300 mm. with ball joint. Brass (1.34.138.30).
- Elbow wall (006.182.01).
- Antilime hand shower (202.639.01).
- Satin hose (91.34.609.15).

Podomítkový termostatický elektronický sprchový set
SHOWER TECHNOLOGY

- Zabudovaná termostatická elektronická kontrolní jednotka (2-cestná).
- Pevná sprcha 300x300 mm. s kloubem. Materiál mosaz (1.34.138.30).
- Držák s nástěnným přívodem vody (006.182.01).
- Ruční sprcha, proti usaz. vod. kamene (202.639.01).
- Flexi hadice SATIN (91.34.609.15).



Cr | 092.865.08

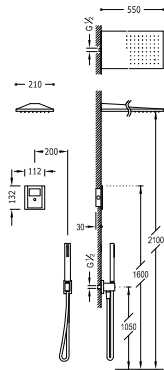

Kit elettronico per doccia termostatico da incasso
SHOWER TECHNOLOGY

- Centralina termostatica elettronica inclusa (2 vie).
- Doccia acciaio inossidabile da parete 210x550 mm. (299.903.02).
- Supporto per doccia (006.182.01).
- Doccetta anticalcare (202.639.01).
- Flessibile satin (91.34.609.15).

Built-in electronic thermostatic shower kit
SHOWER TECHNOLOGY

- Electronic thermostatic control box included (2 ways).
- Stainless steel wall shower 210x550 mm. (299.903.02).
- Elbow wall (006.182.01).
- Antilime hand shower (202.639.01).
- Satin hose (91.34.609.15).

Podomítkový termostatický elektronický sprchový set
SHOWER TECHNOLOGY

- Zabudovaná termostatická elektronická kontrolní jednotka (2-cestná).
- Nástěnné sprchové křepítko z nerez. oceli 210x550 mm. (299.903.02).
- Držák s nástěnným přívodem vody (006.182.01).
- Ruční sprcha, proti usaz. vod. kamene (202.639.01).
- Flexi hadice SATIN (91.34.609.15).



Cr | 092.865.02

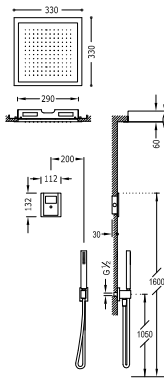

Kit elettronico per doccia termostatico da incasso
SHOWER TECHNOLOGY

- Centralina termostatica elettronica inclusa (2 vie).
- Soffione doccia da 330x330 mm. Ottone (1.34.714).
- Supporto per doccia (006.182.01).
- Doccetta anticalcare (202.639.01).
- Flessibile satin (91.34.609.15).

Built-in electronic thermostatic shower kit
SHOWER TECHNOLOGY

- Electronic thermostatic control box included (2 ways).
- Ceiling shower 330x330 mm. Brass. (1.34.714).
- Elbow wall (006.182.01).
- Antilime hand shower (202.639.01).
- Satin hose (91.34.609.15).

Podomítkový termostatický elektronický sprchový set
SHOWER TECHNOLOGY

- Zabudovaná termostatická elektronická kontrolní jednotka (2-cestná).
- Stropní sprchové křepítko 330x330 mm. Materiál mosaz. (1.34.714).
- Držák s nástěnným přívodem vody (006.182.01).
- Ruční sprcha, proti usaz. vod. kamene (202.639.01).
- Flexi hadice SATIN (91.34.609.15).



Cr | 092.865.01

SPECIALISTI IN GRUPPI TERMOSTATICI EXPERTS IN THERMOSTATIC ASSEMBLIES SPECIALISTÉ NA TERMOSTATICKÉ SOUPRAVY

Qualità e controllo totale / Quality and total control / Kvalita a naprostá kontrola

Con infinite combinazioni possibili, seguendo design tondeggianti o squadriati, sia per la doccia che per la vasca da bagno, TRES si è specializzata nella fabbricazione di gruppi doccia che conferiscono personalità al bagno e offrono grandi momenti di relax nell'acqua. Con finiture di qualità e molteplici funzioni per rendere la doccia o il bagno il momento preferito della giornata. / With endless possible combinations, based on rounded or square designs for showers and bathtubs, TRES has become an expert in the manufacture of shower units that add distinction to the bathroom and enable users to spend enjoyable relaxing moments beneath the shower. With quality finishes and multiple functions to make showering or bathing the favorite time of day. / Díky nespočtu možných kombinací, kulatým i hranatým tvarům jak sprch, tak i van, se společnost TRES stala specialistou na výrobu sprchových souprav, které koupelnám dodávají na příznivém vzhledu a umožňují relaxaci s vodou. S kvalitním provedením a velkým množstvím funkcí učiní ze sprchování příjemný každodenní zážitek.





Grande varietà di soffioni. Di ottone, con snodo orientabile (22°). / **Wide range of shower heads. Made of brass, with an adjustable ball and socket joint (22°).** / Velký výběr křípítek. Z mosazi, s nastavitelným kloubem (22°).

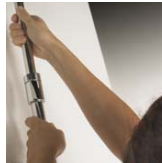

Barra telescopica che consente di definire l'altezza del soffione, secondo le necessità. / **Telescopic bar, allowing the shower head height to be adjusted to suit each need.** / Teleskopická tyč umožňující nastavení výšky křípítka zcela dle Vaší potřeby.

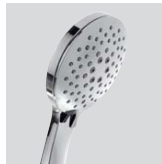

Docce a mano. Con diverse funzioni. / **Hand showers. With different functions.** / Ruční sprchy. S rozličnými funkcemi.



Supporto orientabile. E con altezza regolabile. / **Adjustable holder. With adjustable height.** / Otočné držáky. S nastavitelnou výškou.



Deviatore integrato nella manopola è presente un regolatore di flusso, sia per 2 che per 3 vie. / **Inverter built into the flow rate regulator control (for 2 and 3 outlets).** / Invertor zabudovaný v kotočiči pro regulaci průtoku, jak pro 2 přívody, tak i pro 3.



















Controllo della temperatura. Con pulsante di sicurezza che limita la temperatura a 38 °C. / **Temperature control. With a safety pushbutton that limits the temperature to 38°C.** / Nastavení teploty. S bezpečnostním tlačítkem, který omezuje teplotu na 38 °C.















GRUPPI PERSONALIZZATI PERSONALISED ASSEMBLIES PERSONALIZOVANÉ SOUPRAVY



			
l/m:  11	l/m:  12	l/m:  11	l/m:  11
Cr 1.34.138.26	Cr 299.632.02	Cr 299.632.01	Cr 1.34.137.30
			
l/m:  11	l/m:  14	l/m:  11	l/m:  15
Cr 1.34.138.30	Cr 299.632.03	Cr 1.34.137.26	Cr 299.632.04

+



			
l/m:  16	l/m:  16		
Cr 1.34.611	Cr 1.34.748		
			
l/m:  15	l/m:  12	l/m:  6	l/m:  9.5
Cr 1.34.612	Cr 299.631.08	Cr 299.631.07	Cr 299.748.02

+



			
Cr 007.495.01	Cr 090.495.01	Cr 205.495.01	Cr 081.495.01

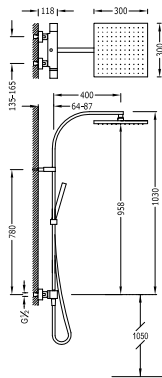

Set doccia CUADRO termostatica

- Doccia fissa 300x300 mm. con snodo. Ottone (1.34.138.30).
- Doccetta anticalcare (006.639.01).
- Flessibile satin (91.34.609.15).
- Invertitore integrato nel regolatore di portata.

Wall thermostatic shower mixer CUADRO

- Fixed shower head 300x300 mm. with ball joint. Brass (1.34.138.30).
- Antilime hand shower (006.639.01).
- Satin hose (91.34.609.15).
- Diverter integrated in the flow control.

Souprava termostatické sprchové baterie CUADRO

- Pevná sprcha 300x300 mm. s kloubem. Materiál mosaz (1.34.138.30).
- Ruční sprcha, proti usaz. vod. kamene (006.639.01).
- Flexi hadice SATIN (91.34.609.15).
- Přepínač zabudovaný v regulaci průtoku.



91.06.161.10

Cr | 1.07.395

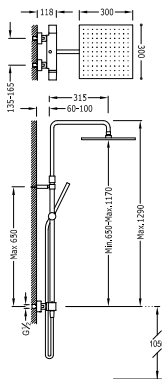

Set doccia CUADRO termostatica

- Doccia fissa 300x300 mm. con snodo. Ottone (1.34.138.30).
- Doccetta anticalcare (006.639.01).
- Flessibile satin (91.34.609.15).
- Asta telescopica.
- Invertitore integrato nel regolatore di portata.

Wall thermostatic shower mixer CUADRO

- Fixed shower head 300x300 mm. with ball joint. Brass (1.34.138.30).
- Antilime hand shower (006.639.01).
- Satin hose (91.34.609.15).
- Telescopic bar.
- Diverter integrated in the flow control.

Souprava termostatické sprchové baterie CUADRO

- Pevná sprcha 300x300 mm. s kloubem. Materiál mosaz (1.34.138.30).
- Ruční sprcha, proti usaz. vod. kamene (006.639.01).
- Flexi hadice SATIN (91.34.609.15).
- Teleskopická tyč.
- Přepínač zabudovaný v regulaci průtoku.



91.06.161.10

Cr | 007.195.01

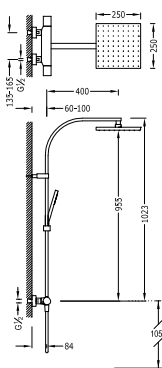

Set doccia CLASS termostatica

- Doccia fissa 250x250 mm. con snodo. (1.34.138.26).
- Doccetta anticalcare (299.631.08).
- Flessibile satin (91.34.609.15).
- Invertitore integrato nel regolatore di portata.

Wall thermostatic shower mixer CLASS

- Fixed shower head 250x250 mm. with ball joint. (1.34.138.26).
- Antilime hand shower (299.631.08)
- Satin hose (91.34.609.15).
- Diverter integrated in the flow control.

Souprava termostatické sprchové baterie CLASS

- Pevná sprcha 250x250 mm. s kloubem. (1.34.138.26).
- Ruční sprcha, proti usaz. vod. kamene (299.631.08).
- Flexi hadice SATIN (91.34.609.15).
- Přepínač zabudovaný v regulaci průtoku.



299.195.03

Cr | 205.395.01

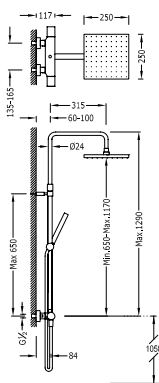
**Set doccia CLASS termostatica**

- Doccia fissa 250x250 mm. con snodo. (1.34.138.26).
- Doccetta anticalcare (299.631.08).
- Flessibile satin (91.34.609.15).
- Asta telescopica.
- Invertitore integrato nel regolatore di portata.

Wall thermostatic shower mixer CLASS

- Fixed shower head 250x250 mm. with ball joint. (1.34.138.26).
- Antilime hand shower (299.631.08).
- Satin hose (91.34.609.15).
- Telescopic bar.
- Diverter integrated in the flow control.

Souprava termostatické sprchové baterie CLASS

- Pevná sprcha 250x250 mm. s kloubem. (1.34.138.26).
- Ruční sprcha, proti usaz. vod. kamene (299.631.08).
- Flexi hadice SATIN (91.34.609.15).
- Teleskopická tyč.
- Přepínač zabudovaný v regulaci průtoku.



299.195.03

Cr 205.385.01

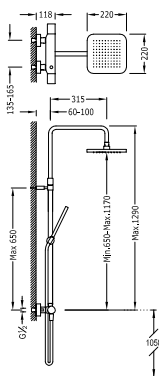
**Set doccia LOFT termostatica**

- Doccia fissa 220x220 mm. con snodo. (299.632.06).
- Doccetta anticalcare (034.639.01).
- Flessibile satin (91.34.609.15).
- Asta telescopica.
- Invertitore integrato nel regolatore di portata.

Wall thermostatic shower mixer LOFT

- Fixed shower head 220x220 mm. with ball joint. (299.632.06).
- Antilime hand shower (034.639.01).
- Satin hose (91.34.609.15).
- Telescopic bar.
- Diverter integrated in the flow control.

Souprava termostatické sprchové baterie LOFT

- Pevná sprcha 220x220 mm. s kloubem. (299.632.06).
- Ruční sprcha, proti usaz. vod. kamene (034.639.01).
- Flexi hadice SATIN (91.34.609.15).
- Teleskopická tyč.
- Přepínač zabudovaný v regulaci průtoku.



299.195.03

Cr 200.195.01

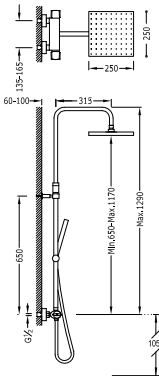
**Set doccia LEX termostatica**

- Doccia fissa 250x250 mm. con snodo. (1.34.138.26).
- Doccetta anticalcare (006.639.01).
- Flessibile satin (91.34.609.15).
- Asta telescopica.
- Invertitore integrato nel regolatore di portata.

Wall thermostatic shower mixer LEX

- Fixed shower head 250x250 mm. with ball joint. (1.34.138.26).
- Antilime hand shower (006.639.01).
- Satin hose (91.34.609.15).
- Telescopic bar.
- Diverter integrated in the flow control.

Souprava termostatické sprchové baterie LEX

- Pevná sprcha 250x250 mm. s kloubem. (1.34.138.26).
- Ruční sprcha, proti usaz. vod. kamene (006.639.01).
- Flexi hadice SATIN (91.34.609.15).
- Teleskopická tyč.
- Přepínač zabudovaný v regulaci průtoku.



91.81.161.10

Cr 1.90.213

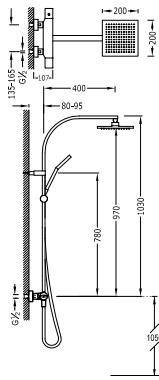

Set doccia FLAT termostatica

- Doccia fissa 200x200 mm. con snodo.
- Doccetta anticalcare 80x80 mm. (1.34.612).
- Flessibile satin (91.34.609.15).
- Invertitore integrato nel regolatore di portata.

Wall thermostatic shower mixer FLAT

- Fixed shower head 200x200 mm. with ball joint.
- Antilime hand shower 80x80 mm. (1.34.612).
- Satin hose (91.34.609.15).
- Diverter integrated in the flow control.

Souprava termostatické sprchové baterie FLAT

- Pevná sprcha 200x200 mm. s kloubem.
- Ruční sprcha, proti usaz. vod. kamene 80x80 mm. (1.34.612).
- Flexi hadice SATIN (91.34.609.15).
- Přepínač zabudovaný v regulaci průtoku.



299.195.08

Cr | 204.395.01

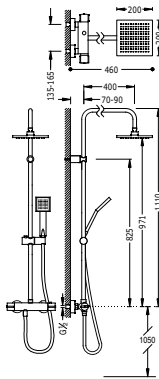

Set doccia FLAT termostatica

- Doccia fissa 200x200 mm. con snodo.
- Doccetta anticalcare 80x80 mm. (1.34.612).
- Flessibile satin (91.34.609.15).
- Invertitore integrato nel regolatore di portata.

Wall thermostatic shower mixer FLAT

- Fixed shower head 200x200 mm. with ball joint.
- Antilime hand shower 80x80 mm. (1.34.612).
- Satin hose (91.34.609.15).
- Diverter integrated in the flow control.

Souprava termostatické sprchové baterie FLAT

- Pevná sprcha 200x200 mm. s kloubem.
- Ruční sprcha, proti usaz. vod. kamene 80x80 mm. (1.34.612).
- Flexi hadice SATIN (91.34.609.15).
- Přepínač zabudovaný v regulaci průtoku.



299.195.08

Cr | 204.387.02

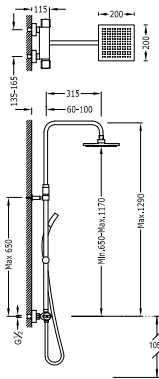

Set doccia FLAT termostatica

- Doccia fissa 200x200 mm. con snodo.
- Doccetta anticalcare 80x80 mm. (1.34.612).
- Flessibile satin (91.34.609.15).
- Asta telescopica.
- Invertitore integrato nel regolatore di portata.

Wall thermostatic shower mixer FLAT

- Fixed shower head 200x200 mm. with ball joint.
- Antilime hand shower 80x80 mm. (1.34.612).
- Satin hose (91.34.609.15).
- Telescopic bar.
- Diverter integrated in the flow control.

Souprava termostatické sprchové baterie FLAT

- Pevná sprcha 200x200 mm. s kloubem.
- Ruční sprcha, proti usaz. vod. kamene 80x80 mm. (1.34.612).
- Flexi hadice SATIN (91.34.609.15).
- Teleskopická tyč.
- Přepínač zabudovaný v regulaci průtoku.



299.195.08

Cr | 204.387.04

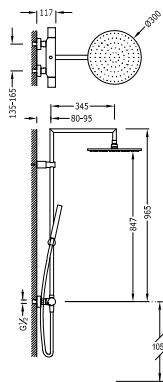

Set doccia MAX termostatica

- Doccia fissa Ø 300 mm. con snodo. Ottone (1.34.137.30).
- Doccetta anticalcare (034.116.01).
- Flessibile satin (91.34.609.15).
- Invertitore integrato nel regolatore di portata.

Wall thermostatic shower mixer MAX

- Fixed shower head Ø 300 mm. with ball joint. Brass. (1.34.137.30).
- Antilime hand shower (034.116.01).
- Satin hose (91.34.609.15).
- Diverter integrated in the flow control.

Souprava termostatické sprchové baterie MAX

- Pevná sprcha Ø 300 mm. s kloubem. Materiál mosaz (1.34.137.30).
- Ruční sprcha, proti usaz. vod. kamene (034.116.01).
- Flexi hadice SATIN (91.34.609.15).
- Přepínač zabudovaný v regulaci průtoku.



299.195.03

Cr 061.393.01

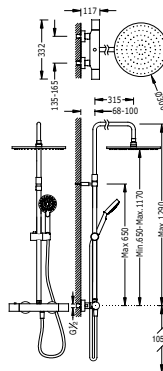

Set doccia MAX termostatica

- Doccia fissa Ø 300 mm. con snodo. Ottone (1.34.137.30).
- Doccetta anticalcare (299.748.02).
- Flessibile satin (91.34.609.15).
- Asta telescopica.
- Invertitore integrato nel regolatore di portata.

Wall thermostatic shower mixer MAX

- Fixed shower head Ø 300 mm. with ball joint. Brass. (1.34.137.30).
- Antilime hand shower (299.748.02).
- Satin hose (91.34.609.15).
- Telescopic bar.
- Diverter integrated in the flow control.

Souprava termostatické sprchové baterie MAX

- Pevná sprcha Ø 300 mm. s kloubem. Materiál mosaz (1.34.137.30).
- Ruční sprcha, proti usaz. vod. kamene (299.748.02).
- Flexi hadice SATIN (91.34.609.15).
- Teleskopická tyč.
- Přepínač zabudovaný v regulaci průtoku.



299.195.03

Cr 061.210.01

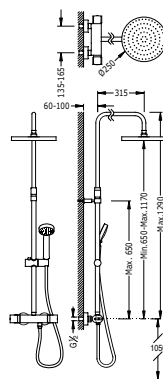

Set doccia LEX/ALPLUS termostatica

- Doccia fissa Ø 250 mm. con snodo. (1.34.137.26).
- Doccetta massaggio Ø 100 mm. (1.34.748).
- Flessibile satin (91.34.609.15).
- Asta telescopica.
- Invertitore integrato nel regolatore di portata.

Wall thermostatic shower mixer LEX/ALPLUS

- Fixed shower head Ø 250 mm. with ball joint. (1.34.137.26).
- Massage hand shower Ø 100 mm. (5 funzioni) (1.34.748)
- Satin hose (91.34.609.15).
- Telescopic bar.
- Diverter integrated in the flow control.

Souprava termostatické sprchové baterie LEX/ALPLUS

- Pevná sprcha Ø 250 mm. s kloubem. (1.34.137.26).
- Ruční masážní sprcha Ø 100 mm. (5 funkcí) (1.34.748).
- Flexi hadice SATIN (91.34.609.15).
- Teleskopická tyč.
- Přepínač zabudovaný v regulaci průtoku.



91.81.161.10

Cr 1.90.214

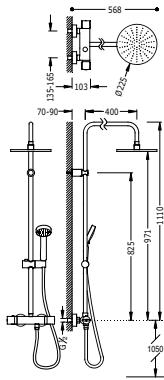

Set doccia LEX/ALPLUS termostatica

- Doccia fissa Ø 225 mm. con snodo. (299.632.01).
- Doccetta massaggio Ø 100 mm. (5 funzioni) (1.34.748).
- Tubo flessibile satin (91.34.609.15).
- Invertitore integrato nel regolatore di portata.

Wall thermostatic shower mixer LEX/ALPLUS

- Fixed shower head Ø 225 mm. with ball joint. (299.632.01).
- Massage hand shower Ø 100 mm. (5 functions) (1.34.748).
- Satin hose (91.34.609.15).
- Diverter integrated in the flow control.

Souprava termostatické sprchové baterie LEX/ALPLUS

- Pevná sprcha Ø 225 mm. s kloubem. (299.632.01).
- Ruční masážní sprcha Ø 100 mm. (5 funkcí) (1.34.748).
- Flexi hadice SATIN (91.34.609.15).
- Přepínač zabudovaný v regulaci průtoku.

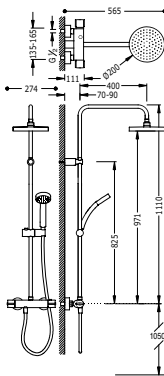

Set doccia FLAT termostatica

- Doccia fissa Ø 200 mm. con snodo.
- Doccetta anticalcare Ø 80 mm. (1.34.617).
- Flessibile satin (91.34.609.15).
- Invertitore integrato nel regolatore di portata.

Wall thermostatic shower mixer FLAT

- Fixed shower head Ø 200 mm. with ball joint.
- Antilime hand shower Ø 80 mm. (1.34.617).
- Satin hose (91.34.609.15).
- Diverter integrated in the flow control.

Souprava termostatické sprchové baterie FLAT

- Pevná sprcha Ø 200 mm. s kloubem.
- Ruční sprcha, proti usaz. vod. kamene Ø 80 mm. (1.34.617).
- Flexi hadice SATIN (91.34.609.15).
- Přepínač zabudovaný v regulaci průtoku.

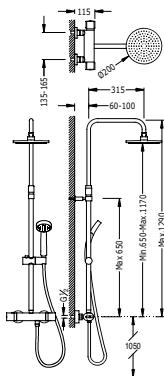

Set doccia FLAT termostatica

- Doccia fissa Ø 200 mm. con snodo.
- Doccetta anticalcare Ø 80 mm. (1.34.617).
- Flessibile satin (91.34.609.15).
- Asta telescopica.
- Invertitore integrato nel regolatore di portata.

Wall thermostatic shower mixer FLAT

- Fixed shower head Ø 200 mm. with ball joint.
- Antilime hand shower Ø 80 mm. (1.34.617).
- Satin hose (91.34.609.15).
- Telescopic bar.
- Diverter integrated in the flow control.

Souprava termostatické sprchové baterie FLAT

- Pevná sprcha Ø 200 mm. s kloubem.
- Ruční sprcha, proti usaz. vod. kamene Ø 80 mm. (1.34.617).
- Flexi hadice SATIN (91.34.609.15).
- Teleskopická tyč.
- Přepínač zabudovaný v regulaci průtoku.



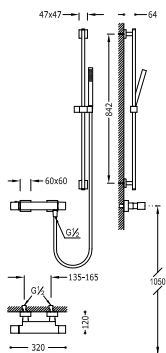

Kit doccia CUADRO termostatica

- Asta antisivolo lungo 842 mm. (1.07.935).
- Doccetta anticalcare (006.639.01).
- Flessibile satin (91.34.609.15).

Wall thermostatic shower mixer CUADRO

- Sliding bar long. 842 mm. (1.07.935).
- Antilime hand shower (006.639.01).
- Satin hose (91.34.609.15)

Sprchová sada s termostatickou baterií CUADRO

- Posuvná tyč 842 mm (1.07.935).
- Ruční sprcha, proti usaz. vod. kamene (006.639.01).
- Flexi hadice SATIN (91.34.609.15).



Cr 007.164.02

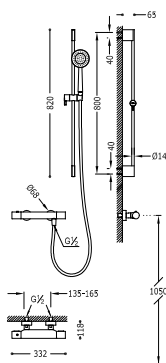

Kit doccia MAX termostatica

- Asta antisivolo lungo 800 mm. (034.637.01).
- Doccetta anticalcare (299.631.03).
- Flessibile satin (91.34.609.15).

Wall thermostatic shower mixer MAX

- Sliding bar long. 800 mm. (034.637.01).
- Antilime hand shower (299.631.03).
- Satin hose (91.34.609.15)

Sprchová sada s termostatickou baterií MAX

- Posuvná tyč 800 mm (034.637.01).
- Ruční sprcha, proti usaz. vod. kamene (299.631.03).
- Flexi hadice SATIN (91.34.609.15).



Cr 062.164.02

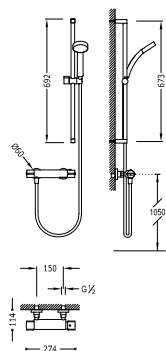

Kit doccia FLAT termostatica

- Asta antisivolo Ø 20,6 mm. lungo 673 mm. (034.637.06).
- Doccetta anticalcare Ø 80 mm. (1.34.617).
- Flessibile doppia graffatura (91.34.828).

Wall thermostatic shower mixer FLAT

- Sliding bar Ø 20,6 mm. long. 673 mm. (034.637.06).
- Antilime hand shower Ø 80 mm. (1.34.617).
- Double interlocked shower hose (91.34.828).

Sprchová sada s termostatickou baterií FLAT

- Posuvná tyč Ø 20,6 mm, délka 673 mm. (034.637.06).
- Ruční sprcha, proti usaz. vod. kamene Ø 80 mm. (1.34.617).
- Flexi hadice s dvojitým zámekem (91.34.828).



Cr 204.196.02

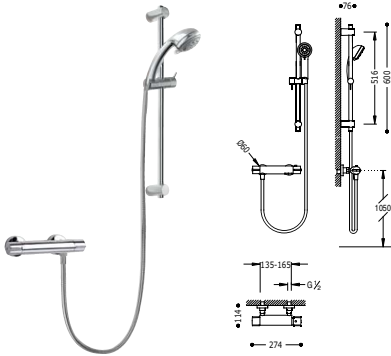

Kit doccia LEX/ALPLUS termostatica

- Doccetta massaggi.
- Asta anticivolo PRACTIC-MAX.
- Vasca LEX/ALPLUS termostatica.

Wall thermostatic shower mixer LEX/ALPLUS

- Massage hand shower.
- Sliding bar PRACTIC-MAX.
- Thermostatic shower LEX/ALPLUS.

Sprchová sada s termostatickou baterií LEX/ALPLUS

- Ruční masážní sprcha.
- Posuvná tyč PRACTIC-MAX.
- Termostatická sprchová baterie LEX/ALPLUS.



Cr | 1.83.395

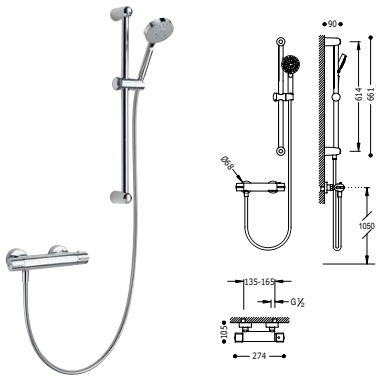

Kit doccia ECO-TERM termostatica

- Asta anticivolo ECO (Ø 25 mm, longo 600 mm).
- Doccetta massaggi Ø 100 mm. (5 funzioni).
- Flessibile satin.

Wall thermostatic shower mixer ECO-TERM

- Sliding bar ECO (Ø 25 mm, long. 600 mm).
- Massage hand shower Ø 100 mm (5 positions).
- Satin hose.

Sprchová sada s termostatickou baterií ECO-TERM

- Posuvná tyč ECO (Ø 25 mm, délka 600 mm).
- Ruční masážní sprcha Ø 100 mm. (5 funkci).
- Flexi hadice SATIN.



299.195.04
REGOLAB
Cr | 090.186.02

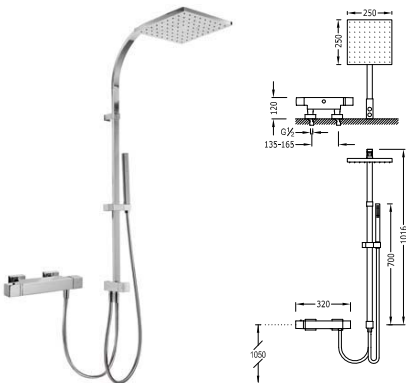

Set doccia CUADRO termostatica

- Doccia fissa 250x250 mm. con snodo. (1.34.138.26).
- Doccetta anticalcare (006.639.01).
- Flessibile satin (91.34.609.15).

Wall thermostatic shower mixer CUADRO

- Fixed shower head 250x250 mm. with ball joint. (1.34.138.26).
- Antilime hand shower (006.639.01).
- Satin hose (91.34.609.15)

Termostatický sprchový set CUADRO

- Hlavová sprcha 250x250 mm. s kloubem. (1.34.138.26).
- Ruční sprcha, proti usaz. vod. kamene (006.639.01).
- Hadice satin (91.34.609.15)



91.06.161.10
Cr | 007.385.01

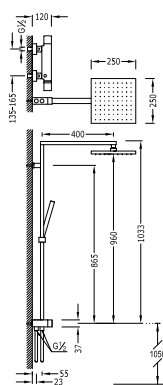

Set doccia CUADRO termostatica

- Doccia fissa 250x250 mm. con snodo. (1.34.138.26).
- Doccetta anticalcare (006.639.01).
- Flessibile satin (91.34.609.15).

Wall thermostatic shower mixer CUADRO

- Fixed shower head 250x250 mm. with ball joint. (1.34.138.26).
- Antilime hand shower (006.639.01).
- Sateen hose (91.34.609.15).

Souprava termostatické sprchové baterie CUADRO

- Pevná sprcha 250x250 mm. s kloubem. (1.34.138.26).
- Ruční sprcha, proti usaz. vod. kamene (006.639.01).
- Flexi hadice SATIN (91.34.609.15).



91.06.161.10
Cr 1.07.964

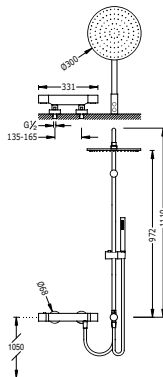

Set doccia MAX termostatica

- Doccia fissa Ø 300 mm. con snodo. Ottone (1.34.137.30).
- Doccetta anticalcare (034.116.01).
- Flessibile satin (91.34.609.15).

Wall thermostatic shower mixer MAX

- Fixed shower head Ø 300 mm. with ball joint. Brass. (1.34.137.30).
- Antilime hand shower (034.116.01).
- Satin hose (91.34.609.15).

Souprava termostatické sprchové baterie MAX

- Pevná sprcha Ø 300 mm. s kloubem. Materiál mosaz (1.34.137.30).
- Ruční sprcha, proti usaz. vod. kamene (034.116.01).
- Flexi hadice SATIN (91.34.609.15).



299.195.03
Cr 061.385.01

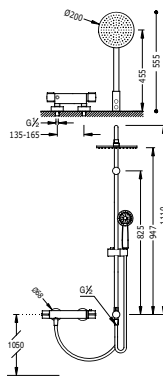

Set doccia FLAT termostatica

- Doccia fissa Ø 200 mm. con snodo (299.632.12).
- Doccetta anticalcare Ø 80 mm. (1.34.617).
- Flessibile satin (91.34.609.15).

Wall thermostatic shower mixer FLAT

- Fixed shower head Ø 200 mm. with ball joint (299.632.12).
- Antilime hand shower Ø 80 mm. (1.34.617).
- Satin hose (91.34.609.15).

Souprava termostatické sprchové baterie FLAT

- Pevná sprcha Ø 200 mm. s kloubem (299.632.12).
- Ruční sprcha, proti usaz. vod. kamene Ø 80 mm. (1.34.617).
- Flexi hadice SATIN (91.34.609.15).



299.195.08
Cr 204.385.01

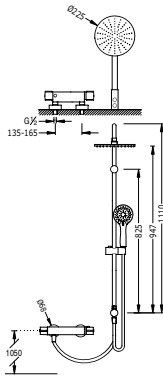

Set doccia ECO-TERM termostatica

- Doccia fissa Ø 225 mm. con snodo. (299.632.01).
- Doccetta massaggio Ø 100 mm. (5 funzioni) (1.34.748).
- Flessibile satin (91.34.609.15).

Wall thermostatic shower mixer ECO-TERM

- Fixed shower head Ø 225 mm. with ball joint. (299.632.01).
- Massage hand shower Ø 100 mm. (5 functions) (1.34.748).
- Satin hose (91.34.609.15).

Souprava termostatické sprchové baterie ECO-TERM

- Pevná sprcha Ø 225 mm. s kloubem. (299.632.01).
- Ruční masážní sprcha Ø 100 mm. (5 funkcí) (1.34.748).
- Flexi hadice SATIN (91.34.609.15).

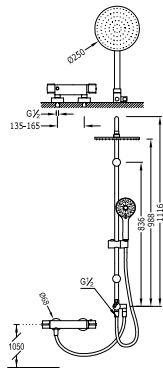

Set doccia ECO-TERM termostatica

- Barra e supporti parete regolabili.
- Doccia fissa Ø 250 mm. con snodo (1.34.137.26).
- Doccetta massaggio Ø 100 mm. (5 funzioni).
- Flessibile satin (91.34.609.15).

Wall thermostatic shower mixer ECO-TERM

- Sliding bar in their wall holder.
- Fixed shower head Ø 250 mm. with ball joint (1.34.137.26).
- Massage hand shower Ø 100 mm. (5 functions).
- Satin hose (91.34.609.15).

Souprava sprchové termostatické baterie ECO-TERM

- Posuvná tyč na nástěnných držácích.
- Pevná sprcha Ø 250 mm. s kloubem (1.34.137.26).
- Ruční masážní sprcha Ø 100 mm. (5 funkcí).
- Flexi hadice SATIN (91.34.609.15).

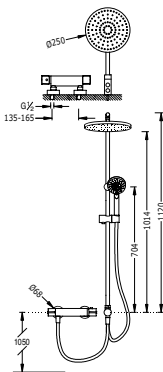

Set doccia ECO-TERM termostatica

- Doccia fissa Ø 250 mm. con snodo (1.34.137.26).
- Doccetta massaggio Ø 100 mm. (5 funzioni).
- Flessibile satin (91.34.609.15).

Wall thermostatic shower mixer ECO-TERM

- Fixed shower head Ø 250 mm. with ball joint (1.34.137.26).
- Massage hand shower Ø 100 mm. (5 functions).
- Satin hose (91.34.609.15).

Souprava termostatické sprchové baterie ECO-TERM

- Pevná sprcha Ø 250 mm. s kloubem (1.34.137.26).
- Ruční masážní sprcha Ø 100 mm. (5 funkcí).
- Flexi hadice SATIN (91.34.609.15).



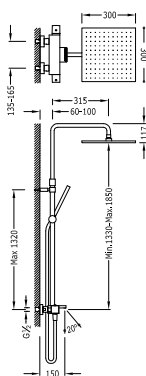

Idrodoccia CUADRO termostatica

- Doccia fissa 300x300 mm. con snodo. Ottone (1.34.138.30).
- Doccetta anticalcare (006.639.01).
- Flessibile satin (91.34.609).
- Asta telescopica.

Wall thermostatic bath mixer CUADRO

- Fixed shower head 300x300 mm. with ball joint. Brass (1.34.138.30).
- Antilime hand shower (006.639.01).
- Satin hose (91.34.609).
- Telescopic bar.

Souprava termostatické baterie pro vanu-sprchu CUADRO

- Pevná sprcha 300x300 mm. s kloubem. Materiál mosaz (1.34.138.30).
- Ruční sprcha, proti usaz. vod. kamene (006.639.01)
- Flexi hadice SATIN (91.34.609).
- Teleskopická tyč.



Cr 007.312.01

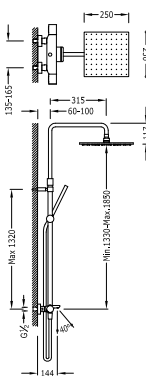

Idrodoccia CLASS termostatica

- Doccia fissa 250x250 mm. con snodo. (1.34.138.26).
- Doccetta anticalcare (299.631.08).
- Flessibile satin (91.34.609).
- Asta telescopica.

Wall thermostatic bath mixer CLASS

- Fixed shower head 250x250 mm. with ball joint. (1.34.138.26).
- Antilime hand shower (299.631.08).
- Satin hose (91.34.609).
- Telescopic bar.

Souprava termostatické baterie pro vanu-sprchu CLASS

- Pevná sprcha 250x250 mm. s kloubem. (1.34.138.26).
- Ruční sprcha, proti usaz. vod. kamene (299.631.08).
- Flexi hadice SATIN (91.34.609).
- Teleskopická tyč.



Cr 205.312.01

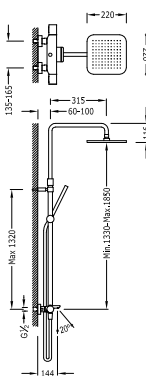

Idrodoccia LOFT termostatica

- Doccia fissa 220x220 mm. con snodo. (299.632.06).
- Doccetta anticalcaire (034.639.01).
- Flessibile satin (91.34.609).
- Asta telescopica.

Wall thermostatic bath mixer LOFT

- Fixed shower head 220x220 mm. with ball joint. (299.632.06).
- Antilime hand shower (034.639.01).
- Satin hose (91.34.609).
- Telescopic bar.

Souprava termostatické baterie pro vanu-sprchu LOFT

- Pevná sprcha 220x220 mm. s kloubem. (299.632.06).
- Ruční sprcha, proti usaz. vod. kamene (034.639.01).
- Flexi hadice SATIN (91.34.609).
- Teleskopická tyč.



Cr 200.312.01

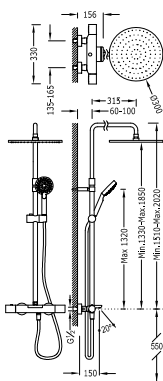

Iidroccia MAX termostatica

- Doccia fissa Ø 300 mm. con snodo. Ottone (1.34.137.30).
- Doccetta anticalcare (299.748.02).
- Flessibile satin (91.34.609).
- Asta telescopica.

Wall thermostatic bath mixer MAX

- Fixed shower head Ø 300 mm. with ball joint. Brass (1.34.137.30).
- Antilime hand shower (299.748.02).
- Satin hose (91.34.609).
- Telescopic bar.

Souprava termostatické baterie pro vanu-sprchu MAX

- Pevná sprcha Ø 300 mm. s kloubem. Materiál mosaz (1.34.137.30).
- Ruční sprcha, proti usaz. vod. kamene (299.748.02).
- Flexi hadice SATIN (91.34.609).
- Teleskopická tyč.



299.195.03

Cr | 062.312.01

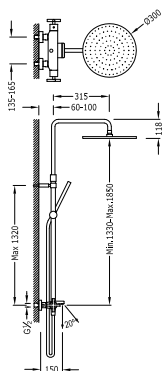

Iidroccia BIMAX termostatica

- Doccia fissa Ø 300 mm. con snodo. Ottone (1.34.137.30).
- Doccetta anticalcare (034.116.01).
- Flessibile satin (91.34.609).
- Asta telescopica.

Wall thermostatic bath mixer BIMAX

- Fixed shower head Ø 300 mm. with ball joint. Brass. (1.34.137.30).
- Antilime hand shower (034.116.01).
- Satin hose (91.34.609).
- Telescopic bar.

Souprava termostatické baterie pro vanu-sprchu BIMAX

- Pevná sprcha Ø 300 mm. s kloubem. Materiál mosaz (1.34.137.30).
- Ruční sprcha, proti usaz. vod. kamene (034.116.01).
- Flexi hadice SATIN (91.34.609).
- Teleskopická tyč.



299.312.02

Cr | 063.312.01



Kit vasca CUADRO termostatica

- Asta anticivolo longo 842 mm. (1.07.935).
- Doccetta anticalcare (006.639.01).
- Flessibile satin (91.34.609).

Thermostatic bathtub CUADRO

- Sliding bar long. 842 mm. (1.07.935).
- Antilime hand shower (006.639.01).
- Satin hose (91.34.609)

Termostatický vanová set CUADRO

- Posuvná tyč 842 mm (1.07.935).
- Ruční sprcha, proti usaz. vod. kamene (006.639.01).
- Flexi hadice SATIN (91.34.609).

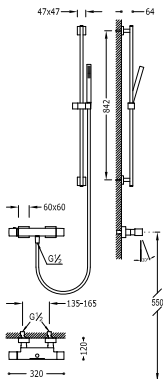

91.06.161.10

Cr | 007.174.02



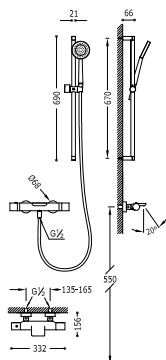

Kit vasca MAX termostatica

- Asta anticivolo Ø 20,6 mm. lungo 673 mm. (034.637.06).
- Doccetta anticalcare (299.631.03).
- Flessibile satin (91.34.609).

Thermostatic bathtub MAX

- Sliding bar Ø 20,6 mm. long. 673 mm. (034.637.06).
- Antilime hand shower (299.631.03).
- Satin hose (91.34.609)

Termostatický vanová set MAX

- Posuvná tyč Ø 20,6 mm, délka 673 mm. (034.637.06).
- Ruční sprcha, proti usaz. vod. kamene (299.631.03).
- Flexi hadice SATIN (91.34.609).



299.195.03

Cr 062.174.02

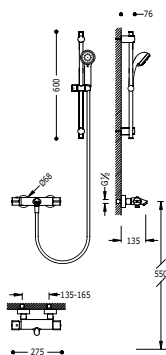

Kit vasca LEX/ALPLUS termostatica

- Asta anticivolo lungo 516 mm. (1.61.835).
- Doccetta massaggi, 3 posizioni (1.34.823).

Thermostatic bathtub LEX/ALPLUS

- Sliding bar long. 516 mm. (1.61.835).
- Massage shower, 3 positions. (1.34.823).

Termostatický vanová set LEX/ALPLUS

- Posuvná tyč 516 mm (1.61.835).
- Masážní sprcha, 3 polohy. (1.34.823).



91.94.161.10

Cr 1.83.398

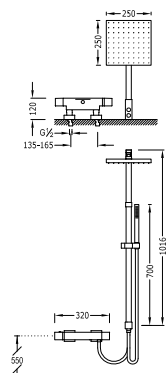

Idrodoccia CUADRO termostatica

- Doccia fissa 250x250 mm. con snodo. (1.34.138.26).
- Doccetta anticalcare (006.639.01).
- Flessibile satin (91.34.609.15)

Wall thermostatic bath mixer CUADRO

- Fixed shower head 250x250 mm. with ball joint. (1.34.138.26).
- Antilime hand shower (006.639.01).
- Satin hose (91.34.609.15)

Termostatický sprchový a vanový set CUADRO

- Pevná sprcha 250x250 mm. s kloubem. (1.34.138.26).
- Ruční sprcha, proti usaz. vod. kamene (006.639.01).
- Hadice satin (91.34.609.15)



91.06.161.10

Cr 007.385.02

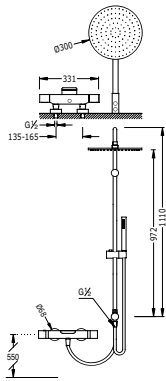

Vasca-Doccia MAX termostatica

- Doccia fissa Ø 300 mm. con snodo. Ottone (1.34.137.30).
- Doccetta anticalcare (034.116.01).
- Flessibile satin (91.34.609.15).

Wall thermostatic shower mixer MAX

- Fixed shower head Ø 300 mm. with ball joint. Brass. (1.34.137.30).
- Antilime hand shower (034.116.01).
- Satin hose (91.34.609.15).

Souprava termostatické baterie pro vanu-sprchu MAX

- Pevná sprcha Ø 300 mm. s kloubem. Materiál mosaz (1.34.137.30).
- Ruční sprcha, proti usaz. vod. kamene (034.116.01).
- Flexi hadice SATIN (91.34.609.15).



299.195.03

Cr | **061.385.02**

PROLUNGHE / EXTENTIONS / PRODLUŽKA

Prolunghe
Extensions
Prodlužka

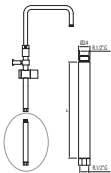

(per ref. / for Nr. / Kód: 90.312, 90.311, 90.310, 90.212, 90.211, 90.210, 90.213, 90.214, 87.355, 87.356, 024.164.04)

L= 300 mm.

Cr | **91.81.195.03**

L= 650 mm.

Cr | **1.81.195.02**

Prolunghe
Extensions
Prodlužka

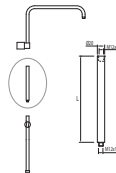

(per ref. / for Nr. / Kód: 012.995.01, 070.995.01, 081.192, 081.495.01, 083.192, 1.81.191, 1.81.386, 1.81.385*)

* ino al 05/2012 - do 05/2012 - until 05/2012

L= 300 mm.

Cr | **91.81.385.03**

L= 650 mm.

Cr | **1.81.385.06**

Prolunghe
Extensions
Prodlužka

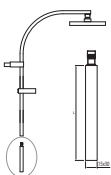

(per ref. / for Nr. / Kód: 1.07.395)

L= 300 mm.

Cr | **91.06.914.03**

L= 500 mm.

Cr | **1.06.914.05**

Prolunghe
Extensions
Prodlužka

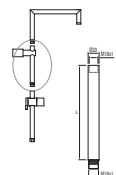

(per ref. / for Nr. / Kód: 90.481, 90.583, 90.281, 90.393)

L= 300 mm.

Cr | **91.34.463.03**

L= 650 mm.

Cr | **1.34.463.02**

Prolunghe
Extensions
Prodlužka

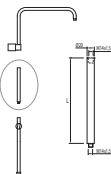

(per ref. / for Nr. / Kód: 90.385, 61.475, 1.81.385**)

** dal 05/2012 - od 05/2012 - since 05/2012

L= 300 mm.

Cr | **91.34.195.03**

L= 650 mm.

Cr | **1.34.195.02**



Desideriamo risaltare Featuring Dovolujeme si upozornit na



Soffione di grande formato. Per una doccia che ti avvolge e ti stimola con una piacevole sensazione di pioggia. / **Large shower head. Enjoy a shower that will envelope and stimulate you with the delightful feeling of rain.** / Velkoformátové sprchy. Získejte sprchu, která vás ovine a vzpruží při příjemném pocitu deště.



Pannello di alluminio anodizzato. Di facile pulizia e massima resistenza alla corrosione e all'usura. Non richiede manutenzione. / **Anodised aluminium control panel. Easy to clean and maximum resistance to corrosion and wear and tear. No maintenance required.** / Panel z anodizovaného hliníku. Snadné čištění a maximální odolnost proti korozi a opotřebení. Nepotřebuje údržbu.



Doccia a mano con funzioni. Aumenta il potere tonificante e rivitalizzante del massaggio ad acqua combinando i diversi getti. / **Hand shower with different functions. Increase the invigorating and revitalising power of a water massage, combining the different jets.** / Ruční sprcha s různými funkcemi. Zvyšuje tonifikační a revitalizační sílu vodní masáže kombinací různých proudů.



Funzioni simultanee. Comandi indipendenti per ogni funzione con cartuccia termostatica a risposta immediata. / **Simultaneous functions. Independent controls for each function, with a thermostatic cartridge that reacts instantly.** / Současné funkce. Samostatné ovládání každé funkce pomocí termostatického ventilu s okamžitou reakcí.

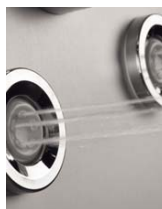

Bocchette orientabili. Per un rilassante massaggio cervicale, dorsale e lombare. / **Adjustable jets. For a relaxing neck, back and lumbar massage.** / Nastavitelné trysky. Pro relaxační masáž šíje, zad a beder.



Montaggio in doccia o vasca da bagno. Ideale per riempire vasche da bagno, regolare la temperatura, rinfrescare i piedi... / **Shower or bathtub installation. Ideal for filling bathtubs, graduating temperature or cooling feet.** / Souprava pro sprchu či vanu. Ideální k plnění van, graduace teploty vody, osvěžení nohou...



COLONNE DOCCIA / SHOWER COLUMNS / SPRCHOVÉ PANELE

Ref. / Nr. / Kód:

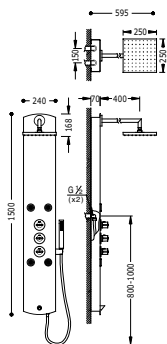

Colonna doccia termostatica LEX-B

- Doccia fissa 250x250 mm. con snodo. (1.34.138.26).
- Doccetta anticalcare.
- Flessibile satin (91.34.609.15).

Thermostatic shower column LEX-B

- Fixed shower head 250x250 mm. with ball joint. (1.34.138.26).
- Antilime hand shower.
- Satin hose (91.34.609.15).

Termostatický vanový panel LEX-B

- Hlavová sprcha 250x250 mm. s kloubem. (1.34.138.26).
- Ruční sprcha, proti usaz. vod. Kamene.
- Hadice satin (91.34.609.15).

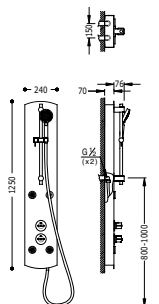

Colonna di vasca termostatica LEX-D

- Doccetta massaggio.
- Flessibile satin (91.34.609.15).

Thermostatic shower column LEX-D

- Massage hand shower.
- Satin hose (91.34.609.15).

Termostatický vanový panel LEX-D

- Masážní ruční sprcha.
- Hadice satin (91.34.609.15).

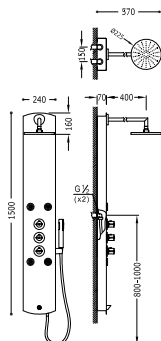
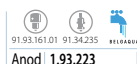

Colonna doccia termostatica LEX-B

- Doccia fissa Ø 225 mm. con snodo. (299.632.01).
- Doccetta anticalcare.
- Flessibile satin (91.34.609.15).

Thermostatic shower column LEX-B

- Fixed shower head Ø 225 mm. with ball joint. (299.632.01).
- Antilime hand shower.
- Satin hose (91.34.609.15).

Termostatický vanový panel LEX-B

- Hlavová sprcha Ø 225 mm. s kloubem. (299.632.01).
- Sprchová koncovka, proti usaz. vod. Kamene.
- Hadice satin (91.34.609.15).



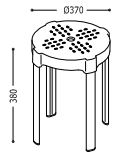

Sgabello da bagno
Peso massimo supportato 225 kg.

Bathroom stool
Max. supported weight 225 kg

Koupełnová stolička
Maximální nosnost 225 kg.



034.636.28

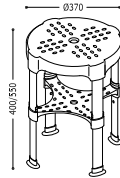

Sgabello da bagno regolabile
Peso massimo supportato 225 kg.

Adjustable bathroom stool
Max. supported weight 225 kg

Nastavitelná koupełnová stolička
Maximální nosnost 225 kg.



034.636.29

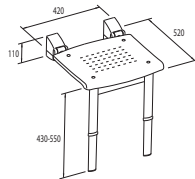

Sedile da doccia piegabile con gambe

Foldable shower chair with legs

Skládací sprchová židle



034.636.30

MONOCOMANDI PER LA DOCCIA

SHOWER MIXER TAPS

SPRCHOVÉ JEDNOPÁKOVÉ BATERIE



Design. Minimalista e dall'estetica moderna. Facili da pulire.
/ Design. Minimalist, modern design. Easy to clean. / Design.
Minimalistický a moderní vzhled. Snadné čištění.



Pratico. Un solo comando apre/chiude il passaggio dell'acqua e regola la temperatura. / Practical. A single control is used to open/close the water flow and adjust the temperature.
/ Praktické. Jediná páka slouží k otevírání a zavírání vody a nastavování teploty.

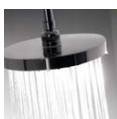

Funzionale. Devia l'uscita dell'acqua tra la doccia a mano e il soffione. / Functional. Switches the water outlet between the hand shower and the shower head. / Funkční. Přepíná výstup vody mezi ruční sprchou a kropítkem.



Durato. Sia per la qualità del materiale che per la sua robustezza. / Durable. Due to the quality of the material and its robustness. / Trvanlivé. Jak díky kvalitě materiálu, tak i díky své robustnosti.

Esempio di un gruppo da superficie

Example of a surface-mounted unit

Příklad povrchové soupravy



Esempio di un gruppo incassato

Example of a built-in unit

Příklad vestavěné soupravy





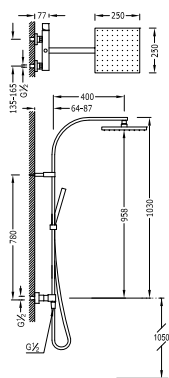

Set doccia CUADRO

- Doccia fissa 250x250 mm. con snodo. (1.34.138.26).
- Doccetta anticalcare (006.639.01).
- Flessibile satin (91.34.609.15).

Bar-shower CUADRO set

- Fixed shower head 250x250 mm. with ball joint. (1.34.138.26).
- Antilime hand shower (006.639.01)
- Satin hose (91.34.609.15).

Sprchová souprava, proti usaz. vod. kamene CUADRO

- Pevná sprcha 250x250 mm. s kloubem. (1.34.138.26).
- Ruční sprcha, proti usaz. vod. kamene (006.639.01).
- Flexi hadice SATIN (91.34.609.15).



91.30.190

Cr 007.191.01



Set doccia CUADRO

- Doccia fissa 250x250 mm. con snodo. (1.34.138.26).
- Doccetta anticalcare (006.639.01).
- Flessibile satin (91.34.609.15).
- Asta telescopica.

Bar-shower CUADRO set

- Fixed shower head 250x250 mm. with ball joint. (1.34.138.26).
- Antilime hand shower (006.639.01)
- Satin hose (91.34.609.15).
- Telescopic bar.

Sprchová souprava, proti usaz. vod. kamene CUADRO

- Pevná sprcha 250x250 mm. s kloubem. (1.34.138.26).
- Ruční sprcha, proti usaz. vod. kamene (006.639.01).
- Flexi hadice SATIN (91.34.609.15).
- Teleskopická tyč.



91.30.190

Cr 007.191.01

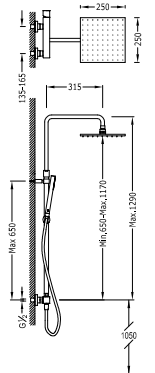

Set doccia LEX

- Doccia fissa 200x200 mm. con snodo. (299.632.11).
- Doccetta anticalcare (1.34.612).
- Flessibile satin (91.34.609.15).

Bar-shower LEX set

- Fixed shower head 200x200 mm. with ball joint. (299.632.11).
- Antilime hand shower (1.34.612).
- Satin hose (91.34.609.15).

Sprchová souprava, proti usaz. vod. kamene LEX

- Pevná sprcha 200x200 mm. s kloubem. (299.632.11).
- Ruční sprcha, proti usaz. vod. kamene (1.34.612).
- Flexi hadice SATIN (91.34.609.15).

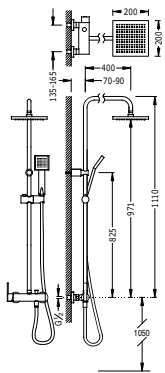

91.34.592

Cr 081.193.01

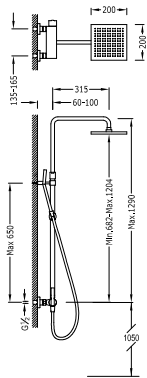

Set doccia LEX

- Doccia fissa 200x200 mm. con snodo. (299.632.11).
- Doccetta anticalcare (1.34.612).
- Flexibile satin (91.34.609.15).
- Asta telescopica.

Bar-shower LEX set

- Fixed shower head 200x200 mm. with ball joint. (299.632.11).
- Antilime hand shower (1.34.612).
- Satin hose (91.34.609.15).
- Telescopic bar.

Sprchová souprava, proti usaz. vod. kamene LEX

- Pevná sprcha 200x200 mm. s kloubem. (299.632.11).
- Ruční sprcha, proti usaz. vod. kamene (1.34.612).
- Flexi hadice SATIN (91.34.609.15).
- Teleskopická tyč.



91.34.592

Cr 081.197.01

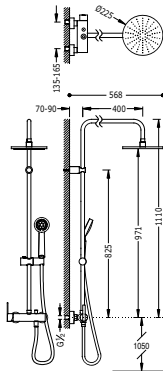

Set doccia LEX

- Doccia fissa Ø 225 mm. con snodo. (299.632.01).
- Doccetta Ø 100 mm. (5 funzioni) (1.34.748).
- Flexibile satin (91.34.609.15).

Bar-shower LEX set

- Fixed shower head Ø 225 mm. with ball joint. (299.632.01).
- Massage hand shower Ø 100 mm. (5 functions) (1.34.748).
- Satin hose (91.34.609.15).

Sprchová souprava, proti usaz. vod. kamene LEX

- Pevná sprcha Ø 225 mm. s kloubem. (299.632.01).
- Ruční masážní sprcha Ø 100 mm. (5 funkci) (1.34.748).
- Flexi hadice SATIN (91.34.609.15).



91.34.592

Cr 1.81.191

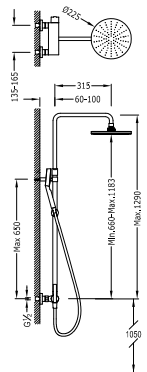

Set doccia LEX

- Doccia fissa Ø 225 mm. con snodo. (299.632.01).
- Doccetta Ø 100 mm. (5 funzioni) (1.34.748).
- Flexibile satin (91.34.609.15).
- Asta telescopica.

Bar-shower LEX set

- Fixed shower head Ø 225 mm. with ball joint. (299.632.01).
- Massage hand shower Ø 100 mm. (5 fonctions) (1.34.748).
- Satin hose (91.34.609.15).
- Telescopic bar.

Sprchová souprava, proti usaz. vod. kamene LEX

- Pevná sprcha Ø 225 mm. s kloubem. (299.632.01).
- Ruční masážní sprcha Ø 100 mm. (5 funkci) (1.34.748).
- Flexi hadice SATIN (91.34.609.15).
- Teleskopická tyč.



91.34.592

Cr 081.197.02

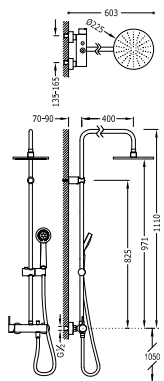
**Set doccia ALPLUS**

- Doccia fissa Ø 225 mm. con snodo. (299.632.01).
- Doccetta anticalcare (299.631.03).
- Flessibile satin (91.34.609.15).

Bar-shower ALPLUS set

- Fixed shower head Ø 225 mm. with ball joint. (299.632.01).
- Antilime hand shower (299.631.03).
- Satin hose (91.34.609.15).

Sprchová souprava, proti usaz. vod. kamene ALPLUS

- Pevná sprcha Ø 225 mm. s kloubem. (299.632.01).
- Ruční sprcha, proti usaz. vod. kamene (299.631.03)
- Flexi hadice SATIN (91.34.609.15).



91.34.592

Cr | 203.191.01

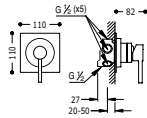

Distributore 5 vie
Con chiusura e regolazione di portata

5-way diverter
With water shut off and flow control

Vestavěný pěticestrý rozdělovač
uzávěrem a regulací průtoku (1 vstup a 5 výstupů)

Cr 1.34.550

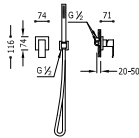

Kit doccia ad incasso CUADRO
Con chiusura e regolazione di portata.
- Corpo incassato incluso
- Supporto per doccia (006.182.01).
- Doccetta anticalcare (006.639.01).
- Flessibile satin (91.34.609.15).

Concealed shower set CUADRO
with water shut off and flow control.
- Built-in body included
- Elbow wall (006.182.01).
- Antilime hand shower (006.639.01).
- Satin hose (91.34.609.15).

Podomítkový jednopákový sprchový set CUADRO
s uzávěrem a regulací průtoku.
- Včetně podomítkového tělesa
- Pevný držák s vodní přípojkou pro hadic. (006.182.01).
- Sprchová koncovka se systémem proti tvorbě vodního kamene (006.639.01).
- Hadice satin (91.34.609.15).

91.30.190
Cr 006.177.03

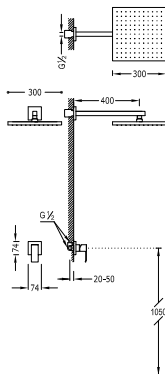

Kit doccia ad incasso CUADRO
Con chiusura e regolazione di portata.
- Corpo incassato incluso
- Doccia fissa 300x300 mm. con snodo. Ottone (1.34.138.30)

Concealed shower set CUADRO
with water shut off and flow control.
- Built-in body included
- Fixed shower head 300x300 mm. with ball joint. Brass (1.34.138.30)

Podomítkový jednopákový sprchový set CUADRO
s uzávěrem a regulací průtoku.
- Včetně podomítkového tělesa
- Hlavová sprcha 300x300 mm. s kloubem. Materiál Mosaz (1.34.138.30)

91.30.190
Cr 1.06.377

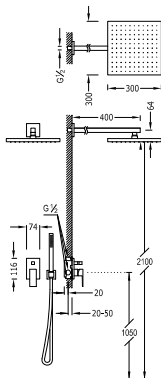

Kit doccia ad incasso CUADRO

Con chiusura e regolazione di portata.

- Corpo incassato incluso
- Doccia fissa 300x300 mm. con snodo. Ottone (1.34.138.30).
- Supporto per doccia (006.182.01).
- Doccetta anticalcare (006.639.01).
- Flessibile satin (91.34.609.15).

Concealed shower set CUADRO

with water shut off and flow control.

- Built-in body included
- Fixed shower head 300x300 mm. with ball joint. Brass. (1.34.138.30).
- Elbow wall (006.182.01).
- Antilime hand shower (006.639.01).
- Satin hose (91.34.609.15).

Podomítkový jednopákový sprchový set CUADRO

s uzávěrem a regulací průtoku.

- Včetně podomítkového tělesa
- Pevná sprcha 300x300 mm. s kloubem. Materiál mosaz. (1.34.138.30).
- Držák s nástěnným přívodem vody (006.182.01).
- Ruční sprcha, proti usaz. vod. kamene (006.639.01).
- Flexi hadice SATIN (91.34.609.15).



91.30.190

Cr | 1.06.980

N

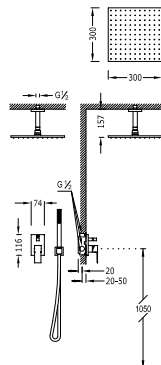

Kit doccia ad incasso CUADRO

Con chiusura e regolazione di portata.

- Corpo incassato incluso
- Doccia fissa 300x300 mm. con snodo. Ottone (1.34.138.30).
- Supporto per doccia (006.182.01).
- Doccetta anticalcare (006.639.01).
- Flessibile satin (91.34.609.15).

Concealed shower set CUADRO

with water shut off and flow control.

- Built-in body included
- Fixed shower head 300x300 mm. with ball joint. Brass. (1.34.138.30).
- Elbow wall (006.182.01).
- Antilime hand shower (006.639.01).
- Satin hose (91.34.609.15).

Podomítkový jednopákový sprchový set CUADRO

s uzávěrem a regulací průtoku.

- Včetně podomítkového tělesa
- Pevná sprcha 300x300 mm. s kloubem. Materiál mosaz. (1.34.138.30).
- Držák s nástěnným přívodem vody (006.182.01).
- Ruční sprcha, proti usaz. vod. kamene (006.639.01).
- Flexi hadice SATIN (91.34.609.15).



91.30.190

Cr | 006.180.80

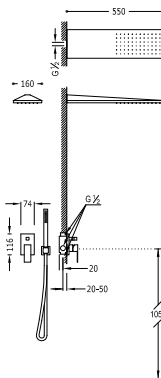

Kit doccia ad incasso CUADRO

Con chiusura e regolazione di portata.

- Corpo incassato incluso
- Doccia acciaio inossidabile da parete 160x550 mm. (299.903.03).
- Supporto per doccia (006.182.01).
- Doccetta anticalcare (006.639.01).
- Flessibile satin (91.34.609.15).

Concealed shower set CUADRO

with water shut off and flow control.

- Built-in body included
- Stainless steel wall shower 160x550 mm. (299.903.03).
- Elbow wall (006.182.01).
- Antilime hand shower (006.639.01).
- Satin hose (91.34.609.15).

Podomítkový jednopákový sprchový set CUADRO

s uzávěrem a regulací průtoku.

- Včetně podomítkového tělesa
- Nástěnné sprchové křepitko z nerez. oceli 160x550 mm (299.903.03).
- Držák s nástěnným přívodem vody. (006.182.01).
- Ruční sprcha, proti usaz. vod. kamene (006.639.01).
- Flexi hadice SATIN (91.34.609.15).



91.30.190

Cr | 006.180.03

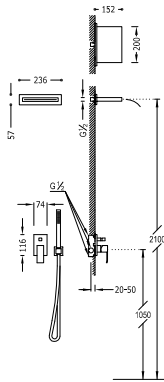

Kit doccia ad incasso CUADRO

Con chiusura e regolazione di portata.

- Corpo incassato incluso
- Doccia acciaio inossidabile con cascata da 152x200 mm.
- Supporto per doccia (006.182.01).
- Doccetta anticalcare (006.639.01).
- Flessibile satin (91.34.609.15).

Concealed shower set CUADRO

with water shut off and flow control.

- Built-in body included
- Stainless steel shower with cascade 152x200 mm.
- Elbow wall (006.182.01).
- Antilime hand shower (006.639.01).
- Satin hose (91.34.609.15).

Podomítkový jednopákový sprchový set CUADRO

s uzávěrem a regulací průtoku.

- Včetně podomítkového tělesa
- Hlavová sprcha nerezová ocel S kaskádou 152x200 mm.
- Držák s nástěnným přívodem vody (006.182.01).
- Ruční sprcha, proti usaz. vod. kamene (006.639.01).
- Flexi hadice SATIN (91.34.609.15).



91.30.190

Cr 006.180.06

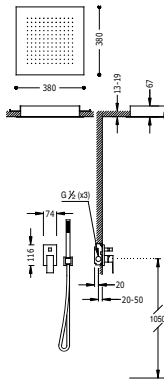

Kit doccia ad incasso CUADRO

Con chiusura e regolazione di portata.

- Corpo incassato incluso
- Soffione doccia acciaio inossidabile 380x380 mm. (1.34.944).
- Supporto per doccia (006.182.01).
- Doccetta anticalcare (006.639.01).
- Flessibile satin (91.34.609.15).

Concealed shower set CUADRO

with water shut off and flow control.

- Built-in body included
- Steel shower head 380x380 mm. (1.34.944).
- Elbow wall (006.182.01).
- Antilime hand shower (006.639.01).
- Satin hose (91.34.609.15).

Podomítkový jednopákový sprchový set CUADRO

s uzávěrem a regulací průtoku.

- Včetně podomítkového tělesa
- Sprchové křepítko z nerez. oceli 380x380 mm. (1.34.944).
- Držák s nástěnným přívodem vody (006.182.01).
- Ruční sprcha, proti usaz. vod. kamene (006.639.01).
- Flexi hadice SATIN (91.34.609.15).



91.30.190

Cr 006.980.01

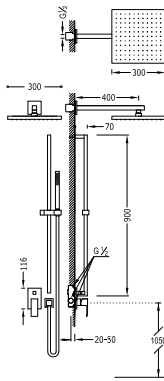

Kit doccia ad incasso CUADRO

Con chiusura e regolazione di portata.

- Corpo incassato incluso
- Doccia fissa 300x300 mm. con snodo. Ottone (1.34.138.30).
- Asta antiscivolo lunga 900 mm. Ottone (1.07.935).
- Pressa a parete (006.183.01).
- Doccetta anticalcare (006.639.01).
- Flessibile satin (91.34.609.15).

Concealed shower set CUADRO

with water shut off and flow control.

- Built-in body included
- Fixed shower head 300x300 mm. with ball joint. Brass. (1.34.138.30).
- Bar-shower antilime, long, 900 mm. Brass (1.07.935).
- Elbow wall (006.183.01).
- Antilime hand shower (006.639.01).
- Satin hose (91.34.609.15).

Podomítkový jednopákový sprchový set CUADRO

s uzávěrem a regulací průtoku.

- Včetně podomítkového tělesa
- Hlavová sprcha 300x300 mm. s kloubem. Materiál. Mosaz (1.34.138.30).
- Posuvná tyč. Délka 900 mm. Materiál. Mosaz (1.07.935).
- Pevný držák s vodní přípojkou pro hadici (006.183.01).
- Ruční sprcha, proti usaz. vod. kamene (006.639.01).
- Hadice satin (91.34.609.15).



91.30.190

Cr 1.06.985

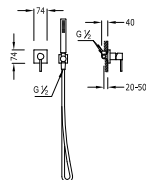

Kit doccia ad incasso MAX

- Con chiusura e regolazione di portata.
 · Corpo incassato incluso
 · Supporto per doccia (061.182.01).
 · Doccetta anticalcare (034.116.01).
 · Flessibile satin (91.34.609.15).

Concealed shower set MAX

- with water shut off and flow control.
 · Built-in body included
 · Elbow wall (061.182.01).
 · Antilime hand shower (034.116.01).
 · Satin hose (91.34.609.15).

Podomítkový jednopákový sprchový set MAX

- s uzávěrem a regulací průtoku.
 · Včetně podomítkového tělesa
 · Držák s nástěnným přívodem vody (061.182.01).
 · Ruční sprcha, proti usaz. vod. kamene (034.116.01).
 · Flexi hadice SATIN (91.34.609.15).



91.30.190

Cr 062.177.03

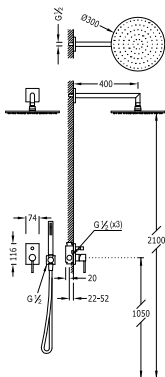

Kit doccia ad incasso MAX

- Con chiusura e regolazione di portata.
 · Corpo incassato incluso
 · Doccia fissa Ø 300 mm. con snodo. (1.34.137.30). Ottone.
 · Supporto per doccia (061.182.01).
 · Doccetta anticalcare (034.116.01).
 · Flessibile satin (91.34.609.15).

Concealed shower set MAX

- with water shut off and flow control.
 · Built-in body included
 · Fixed shower head Ø 300 mm. with ball joint. (1.34.137.30). Brass.
 · Elbow wall (061.182.01).
 · Antilime hand shower (034.116.01).
 · Satin hose (91.34.609.15).

Podomítkový jednopákový sprchový set MAX

- s uzávěrem a regulací průtoku.
 · Včetně podomítkového tělesa
 · Pevná sprcha Ø 300 mm. s kloubem. (1.34.137.30). Materiál mosaz.
 · Držák s nástěnným přívodem vody (061.182.01).
 · Ruční sprcha, proti usaz. vod. kamene (034.116.01).
 · Flexi hadice SATIN (91.34.609.15).



91.30.190

Cr 062.980.01

N

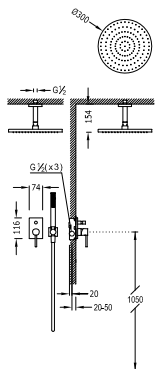

Kit doccia ad incasso MAX

- Con chiusura e regolazione di portata.
 · Corpo incassato incluso
 · Doccia fissa Ø 300 mm. con snodo. (1.34.137.30). Ottone.
 · Supporto per doccia (061.182.01).
 · Doccetta anticalcare (034.116.01).
 · Flessibile satin (91.34.609.15).

Concealed shower set MAX

- with water shut off and flow control.
 · Built-in body included
 · Fixed shower head Ø 300 mm. with ball joint. (1.34.137.30). Brass.
 · Elbow wall (061.182.01).
 · Antilime hand shower (034.116.01).
 · Satin hose (91.34.609.15).

Podomítkový jednopákový sprchový set MAX

- s uzávěrem a regulací průtoku.
 · Včetně podomítkového tělesa
 · Pevná sprcha Ø 300 mm. s kloubem. (1.34.137.30). Materiál mosaz.
 · Držák s nástěnným přívodem vody (061.182.01).
 · Ruční sprcha, proti usaz. vod. kamene (034.116.01).
 · Flexi hadice SATIN (91.34.609.15).



91.30.190

Cr 062.180.80

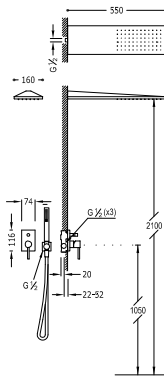

Kit doccia ad incasso MAX

Con chiusura e regolazione di portata.

- Corpo incassato incluso
- Doccia acciaio inossidabile da parete 160x550 mm. (299.903.03).
- Supporto per doccia (061.182.01).
- Doccetta anticalcare (034.116.01).
- Flessibile satin (91.34.609.15).

Concealed shower set MAX

with water shut off and flow control.

- Built-in body included
- Stainless steel wall shower 160x550 mm. (299.903.03).
- Elbow wall (061.182.01).
- Antilime hand shower (034.116.01).
- Satin hose (91.34.609.15).

Podomítkový jednopákový sprchový set MAX

s uzávěrem a regulací průtoku.

- Včetně podomítkového tělesa
- Nástěnné sprchové křepitko z nerez. oceli 160x550 mm (299.903.03).
- Držák s nástěnným přívodem vody (061.182.01).
- Ruční sprcha, proti usaz. vod. kamene (034.116.01).
- Flexi hadice SATIN (91.34.609.15).



91.30.190

Cr 062.516.01

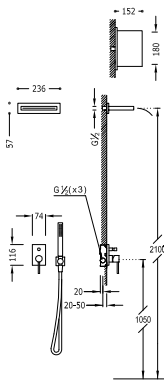

Kit doccia ad incasso MAX

Con chiusura e regolazione di portata.

- Corpo incassato incluso
- Doccia acciaio inossidabile con cascata 152x200 mm.
- Supporto per doccia (061.182.01).
- Doccetta anticalcare (034.116.01).
- Flessibile satin (91.34.609.15).

Concealed shower set MAX

with water shut off and flow control.

- Built-in body included
- Stainless steel shower with cascade 152x200 mm.
- Elbow wall (061.182.01).
- Antilime hand shower (034.116.01).
- Satin hose (91.34.609.15).

Podomítkový jednopákový sprchový set MAX

s uzávěrem a regulací průtoku.

- Včetně podomítkového tělesa
- Sprcha z nerez. oceli s kaskádou 152x200 mm.
- Držák s nástěnným přívodem vody (061.182.01).
- Ruční sprcha, proti usaz. vod. kamene (034.116.01).
- Flexi hadice SATIN (91.34.609.15).



91.30.190

Cr 062.180.05

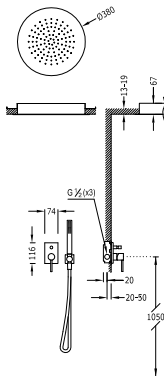

Kit doccia ad incasso MAX

Con chiusura e regolazione di portata.

- Corpo incassato incluso
- Soffione doccia acciaio inossidabile Ø 380 mm. (1.34.940).
- Supporto per doccia (061.182.01).
- Doccetta anticalcare (034.116.01).
- Flessibile satin (91.34.609.15).

Concealed shower set MAX

with water shut off and flow control.

- Built-in body included
- Steel shower head Ø 380 mm. (1.34.940).
- Elbow wall (061.182.01).
- Antilime hand shower (034.116.01).
- Satin hose (91.34.609.15).

Podomítkový jednopákový sprchový set MAX

s uzávěrem a regulací průtoku.

- Včetně podomítkového tělesa
- Sprchové křepitko z nerez. oceli Ø 380 mm. (1.34.940).
- Držák s nástěnným přívodem vody (061.182.01).
- Ruční sprcha, proti usaz. vod. kamene (034.116.01).
- Flexi hadice SATIN (91.34.609.15).



91.30.190

Cr 062.180.09

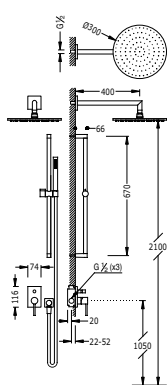

Kit doccia ad incasso MAX

Con chiusura e regolazione di portata.

- Corpo incassato incluso
- Doccia fissa Ø 300 mm. con snodo. Ottone (1.34.137.30).
- Asta antiscivolo lunga 673 mm. Ottone (034.637.06).
- Presa a parete (061.183.01).
- Doccetta anticalcare (034.116.01).
- Flessibile satin (91.34.609.15).

Concealed shower set MAX

with water shut off and flow control.

- Built-in body included
- Fixed shower head Ø 300 mm. with ball joint. Brass. (1.34.137.30).
- Bar-shower antilime. long. 673 mm. Brass (034.637.06).
- Elbow wall (061.183.01).
- Antilime hand shower (034.116.01).
- Satin hose (91.34.609.15).

Podomítkový jednopákový sprchový set MAX

s uzávěrem a regulací průtoku.

- Včetně podomítkového tělesa
- Hlavová sprcha Ø 300 mm. s kloubem. Materiál Mosaz (1.34.137.30).
- Posuvná tyč. Délka 673 mm. Materiál Mosaz (034.637.06).
- Pevný držák s vodní přípojkou pro hadici (061.183.01).
- Ruční sprcha, proti usaz. vod. kamene (034.116.01).
- Flexi hadice SATIN (91.34.609.15).



Cr 062.980.02

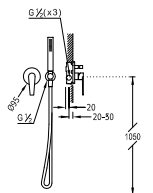

Kit doccia ad incasso CLASS

Con chiusura e regolazione di portata.

- Corpo incassato incluso
- Supporto per doccia (205.182.01).
- Doccetta anticalcare (299.631.08).
- Flessibile satin (91.34.609.15).

Concealed shower set CLASS

with water shut off and flow control.

- Built-in body included
- Elbow wall (205.182.01).
- Antilime hand shower (299.631.08).
- Satin hose (91.34.609.15).

Podomítkový jednopákový sprchový set CLASS

s uzávěrem a regulací průtoku.

- Včetně podomítkového tělesa
- Držák s nástěnným přívodem vody (205.182.01).
- Ruční sprcha, proti usaz. vod. kamene (299.631.08).
- Flexi hadice SATIN (91.34.609.15).



Cr 205.177.02

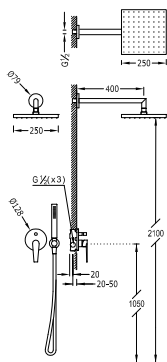

Kit doccia ad incasso CLASS

Con chiusura e regolazione di portata.

- Corpo incassato incluso
- Doccia fissa 250x250 mm. con snodo. (1.34.138.26).
- Supporto per doccia (205.182.01).
- Doccetta anticalcare (299.631.08).
- Flessibile satin (91.34.609.15).

Concealed shower set CLASS

with water shut off and flow control.

- Built-in body included
- Fixed shower head 250x250 mm. with ball joint. (1.34.138.26).
- Elbow wall (205.182.01).
- Antilime hand shower (299.631.08).
- Satin hose (91.34.609.15).

Podomítkový jednopákový sprchový set CLASS

s uzávěrem a regulací průtoku.

- Včetně podomítkového tělesa
- Pevná sprcha 250x250 mm. s kloubem. (1.34.138.26).
- Držák s nástěnným přívodem vody (205.182.01).
- Ruční sprcha, proti usaz. vod. kamene (299.631.08).
- Flexi hadice SATIN (91.34.609.15).



Cr 205.180.02



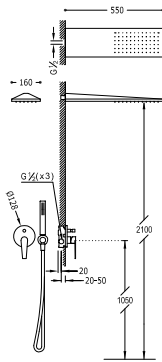

Kit doccia ad incasso CLASS

Con chiusura e regolazione di portata.

- Corpo incassato incluso
- Doccia acciaio inossidabile da parete 160x550 mm. (299.903.03).
- Supporto per doccia (205.182.01).
- Doccetta anticalcare (299.631.08).
- Flessibile satin (91.34.609.15).

Concealed shower set CLASS

with water shut off and flow control.

- Built-in body included
- Stainless steel wall shower 160x550 mm. (299.903.03).
- Elbow wall (205.182.01).
- Antilime hand shower (299.631.08).
- Satin hose (91.34.609.15).

Podomítkový jednopákový sprchový set CLASS

s uzávěrem a regulací průtoku.

- Včetně podomítkového tělesa
- Nástěnné sprchové křepítko z nerez. oceli 160x550 mm (299.903.03).
- Držák s nástěnným přívodem vody (006.182.01).
- Ruční sprcha, proti usaz. vod. kamene (299.631.08).
- Flexi hadice SATIN (91.34.609.15).



Cr | 205.180.03

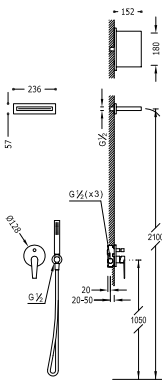

Kit doccia ad incasso CLASS

Con chiusura e regolazione di portata.

- Corpo incassato incluso
- Doccia acciaio inossidabile con cascata da 152x200 mm.
- Supporto per doccia (205.182.01).
- Doccetta anticalcare (299.631.08).
- Flessibile satin (91.34.609.15).

Concealed shower set CLASS

with water shut off and flow control.

- Built-in body included
- Stainless steel shower with cascade 152x200 mm.
- Elbow wall (205.182.01).
- Antilime hand shower (299.631.08).
- Satin hose (91.34.609.15).

Podomítkový jednopákový sprchový set CLASS

s uzávěrem a regulací průtoku.

- Včetně podomítkového tělesa
- Sprcha z nerez. oceli s kaskádou 152x200 mm.
- Držák s nástěnným přívodem vody (205.182.01).
- Ruční sprcha, proti usaz. vod. kamene (299.631.08).
- Flexi hadice SATIN (91.34.609.15).



Cr | 205.180.04

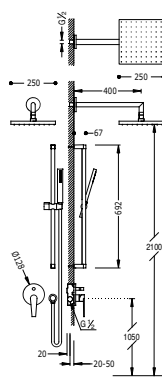

Kit doccia ad incasso CLASS

Con chiusura e regolazione di portata.

- Corpo incassato incluso
- Doccia fissa 250x250 mm. con snodo. (1.34.138.26).
- Asta antiscivolo lunga 673 mm. (034.637.06).
- Pressa a parete (1.34.757).
- Doccetta anticalcare (299.631.08).
- Flessibile satin (91.34.609.15).

Concealed shower set CLASS

with water shut off and flow control.

- Built-in body included
- Fixed shower head 250x250 mm. with ball joint. (1.34.138.26).
- Sliding bar long. 673 mm. (034.637.06).
- Elbow wall (1.34.757).
- Antilime hand shower (299.631.08).
- Satin hose (91.34.609.15).

Podomítkový jednopákový sprchový set CLASS

s uzávěrem a regulací průtoku.

- Včetně podomítkového tělesa
- Pevná sprcha 250x250 mm. s kloubem. (1.34.138.26).
- Posuvná tyč 673 mm (034.637.06).
- Kolínko nást. Přívodem (1.34.757).
- Ruční sprcha, proti usaz. vod. kamene (299.631.08).
- Flexi hadice SATIN (91.34.609.15).



Cr | 205.180.05

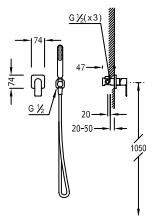

Kit doccia ad incasso LOFT

Con chiusura e regolazione di portata.

- Corpo incassato incluso
- Supporto per doccia (200.182.01).
- Doccetta anticalcare (034.639.01).
- Flessibile satin (91.34.609.15).

Concealed shower set LOFT

with water shut off and flow control.

- Built-in body included
- Elbow wall (200.182.01).
- Antilime hand shower (034.639.01).
- Satin hose (91.34.609.15).

Podomítkový jednopákový sprchový set LOFT

s uzávěrem a regulací průtoku.

- Včetně podomítkového tělesa
- Držák s nástěnným přívodem vody (200.182.01).
- Ruční sprcha, proti usaz. vod. kamene (034.639.01).
- Flexi hadice SATIN (91.34.609.15).

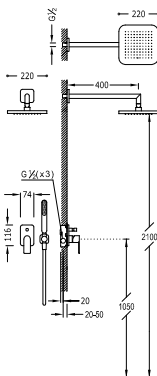

Kit doccia ad incasso LOFT

Con chiusura e regolazione di portata.

- Corpo incassato incluso
- Doccia fissa 220x220 mm. con snodo. (299.632.06).
- Supporto per doccia (200.182.01).
- Doccetta anticalcare (034.639.01).
- Flessibile satin (91.34.609.15).

Concealed shower set LOFT

with water shut off and flow control.

- Built-in body included
- Fixed shower head 220x220 mm. with ball joint. (299.632.06).
- Elbow wall (200.182.01).
- Antilime hand shower (034.639.01).
- Satin hose (91.34.609.15).

Podomítkový jednopákový sprchový set LOFT

s uzávěrem a regulací průtoku.

- Včetně podomítkového tělesa
- Pevná sprcha 220x220 mm. s kloubem. (299.632.06).
- Držák s nástěnným přívodem vody (200.182.01).
- Ruční sprcha, proti usaz. vod. Kamene (034.639.01).
- Flexi hadice SATIN (91.34.609.15).

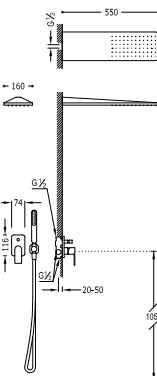

Kit doccia ad incasso LOFT

Con chiusura e regolazione di portata.

- Corpo incassato incluso
- Doccia acciaio inossidabile da parete 160x550 mm. (299.903.06).
- Supporto per doccia (200.182.01).
- Doccetta anticalcare (034.639.01).
- Flessibile satin (91.34.609.15).

Concealed shower set LOFT

with water shut off and flow control.

- Built-in body included
- Stainless steel wall shower 160x550 mm. (299.903.06).
- Elbow wall (200.182.01).
- Antilime hand shower (034.639.01).
- Satin hose (91.34.609.15).

Podomítkový jednopákový sprchový set LOFT

s uzávěrem a regulací průtoku.

- Včetně podomítkového tělesa
- Nástěnné sprchové křepitko z nerez. oceli 160x550 mm. (299.903.06).
- Držák s nástěnným přívodem vody (200.182.01).
- Ruční sprcha, proti usaz. vod. Kamene (034.639.01).
- Flexi hadice SATIN (91.34.609.15).



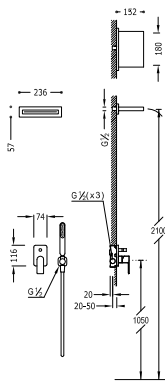

Kit doccia ad incasso LOFT

Con chiusura e regolazione di portata.

- Corpo incassato incluso
- Doccia acciaio inossidabile con cascata 152x200 mm. (299.903.04).
- Supporto per doccia (200.182.01).
- Doccetta anticalcare (034.639.01).
- Flessibile satin (91.34.609.15).

Concealed shower set LOFT

with water shut off and flow control.

- Built-in body included
- Stainless steel shower with cascade 152x200 mm. (299.903.04).
- Elbow wall (200.182.01).
- Antilime hand shower (034.639.01).
- Satin hose (91.34.609.15).

Podomítkový jednopákový sprchový set LOFT

s uzávěrem a regulací průtoku.

- Včetně podomítkového tělesa
- Sprcha z nerez. oceli s kaskádou 152x200 mm. (299.903.04).
- Držák s nástěnným přívodem vody (200.182.01).
- Ruční sprcha, proti usaz. vod. kamene (034.639.01).
- Flexi hadice SATIN (91.34.609.15).



91.30.190

Cr | 200.180.04

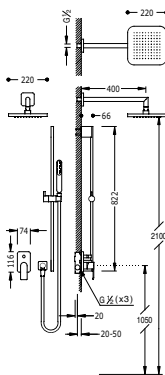

Kit doccia ad incasso LOFT

Con chiusura e regolazione di portata.

- Corpo incassato incluso
- Doccia fissa 220x220 mm. con snodo. (299.632.06).
- Asta antiscivolo lunga 820 mm. (034.637.01).
- Angolo presa parete flessibile (200.183.01).
- Doccetta anticalcare (034.639.01).
- Flessibile satin (91.34.609.15).

Concealed shower set LOFT

with water shut off and flow control.

- Built-in body included
- Fixed shower head 220x220 mm. with ball joint. (299.632.06).
- Bar-shower antilime, long. 820 mm. (034.637.01).
- Wall elbow adapter for shower hose (200.183.01).
- Antilime hand shower (034.639.01).
- Satin hose (91.34.609.15).

Podomítkový jednopákový sprchový set LOFT

s uzávěrem a regulací průtoku.

- Včetně podomítkového tělesa
- Pevná sprcha 220x220 mm. s kloubem. (299.632.06).
- Kolínko nást. přívodemem (200.183.01).
- Posuvná tyč 820 mm (034.637.01).
- Ruční sprcha, proti usaz. vod. Kamene (034.639.01).
- Flexi hadice SATIN (91.34.609.15).



91.30.190

Cr | 200.180.03

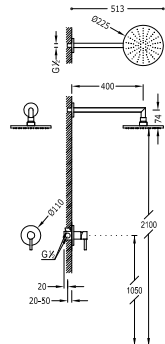

Kit doccia ad incasso ALPLUS

Con chiusura e regolazione di portata.

- Corpo incassato incluso
- Doccia fissa Ø 225 mm. con snodo. (299.632.01).

Concealed shower set ALPLUS

with water shut off and flow control.

- Built-in body included
- Fixed shower head Ø 225 mm. with ball joint. (299.632.01).

Podomítkový jednopákový sprchový set ALPLUS

s uzávěrem a regulací průtoku.

- Včetně podomítkového tělesa
- Pevná sprcha Ø 225 mm. s kloubem. (299.632.01).



91.34.592

Cr | 203.177.02

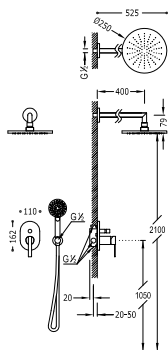

Kit doccia ad incasso LEX

Con chiusura e regolazione di portata.

- Corpo incassato incluso
- Doccia fissa Ø 250 mm. con snodo. (1.34.137.26).
- Supporto per doccia (205.182.01).
- Doccetta Ø 100 mm. (5 funzioni) (1.34.748).
- Flessibile satin (91.34.609.15).

Concealed shower set LEX

with water shut off and flow control.

- Built-in body included
- Fixed shower head Ø 250 mm. with ball joint. (1.34.137.26).
- Elbow wall (205.182.01).
- Massage hand shower Ø 100 mm. (5 functions) (1.34.748).
- Satin hose (91.34.609.15).

Podomítkový jednopákový sprchový set LEX

s uzávěrem a regulací průtoku.

- Včetně podomítkového tělesa
- Pevná sprcha Ø 250 mm. s kloubem. (1.34.137.26).
- Držák s nástěnným přívodem vody (205.182.01).
- Ruční masážní sprcha Ø 100 mm (5 funkcí) (1.34.748).
- Flexi hadice SATIN (91.34.609.15).



91.34.592

Cr 1.81.880.05

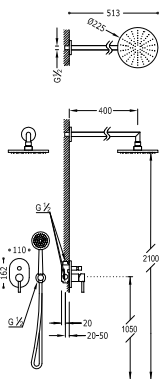

Kit doccia ad incasso ALPLUS

Con chiusura e regolazione di portata.

- Corpo incassato incluso
- Doccia fissa Ø 225 mm. con snodo. (299.632.01).
- Supporto per doccia (205.182.01).
- Doccetta anticalcare (299.631.03).
- Flessibile satin (91.34.609.15).

Concealed shower set ALPLUS

with water shut off and flow control.

- Built-in body included
- Fixed shower head Ø 225 mm. with ball joint. (299.632.01).
- Elbow wall (205.182.01).
- Antilime hand shower (299.631.03).
- Satin hose (91.34.609.15).

Podomítkový jednopákový sprchový set ALPLUS

s uzávěrem a regulací průtoku.

- Včetně podomítkového tělesa
- Pevná sprcha Ø 225 mm. s kloubem. (299.632.01).
- Držák s nástěnným přívodem vody (205.182.01).
- Ruční sprcha, proti usaz. vod. kamene (299.631.03).
- Flexi hadice SATIN (91.34.609.15).



91.34.592

Cr 203.180.02

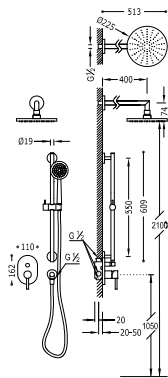

Kit doccia ad incasso ALPLUS

Con chiusura e regolazione di portata.

- Corpo incassato incluso
- Doccia fissa Ø 225 mm. con snodo. (299.632.01).
- Asta anticivolo lunga 550 mm. (1.34.618).
- Presa a parete (205.183.01).
- Doccetta anticalcare (299.631.03).
- Flessibile satin (91.34.609.15).

Concealed shower set ALPLUS

with water shut off and flow control.

- Built-in body included
- Fixed shower head Ø 225 mm. with ball joint. (299.632.01).
- Bar-shower antilime. long. 550 mm. (1.34.618).
- Elbow wall (205.183.01).
- Antilime hand shower (299.631.03).
- Satin hose (91.34.609.15).

Podomítkový jednopákový sprchový set ALPLUS

s uzávěrem a regulací průtoku.

- Včetně podomítkového tělesa
- Pevná sprcha Ø 225 mm. s kloubem. (299.632.01).
- Poutná tyč 550 mm (1.34.618).
- Količko nástěnný přívod (205.183.01).
- Ruční sprcha, proti usaz. vod. kamene (299.631.03).
- Flexi hadice SATIN (91.34.609.15).



91.34.592

Cr 203.180.03

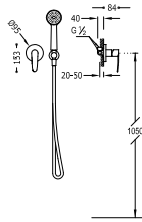

Kit doccia ad incasso FLAT

Con chiusura e regolazione di portata.

- Corpo incassato incluso
- Supporto per doccia (205.182.01).
- Doccetta anticalcare (1.34.617).
- Flessibile satin (91.34.609.15).

Concealed shower set FLAT

with water shut off and flow control.

- Built-in body included
- Elbow wall (205.182.01).
- Antilime hand shower (1.34.617).
- Satin hose (91.34.609.15).

Podomítkový jednopákový sprchový set FLAT

s uzávěrem a regulací průtoku.

- Včetně podomítkového tělesa
- Držák s nástěnným přívodem vody (205.182.01).
- Ruční sprcha, proti usaz. vod. kamene (1.34.617).
- Flexi hadice SATIN (91.34.609.15).



Cr 204.177.02

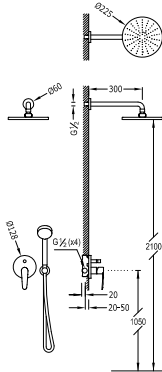

Kit doccia ad incasso FLAT

Con chiusura e regolazione di portata.

- Corpo incassato incluso
- Doccia fissa Ø 225 mm. con snodo. (299.632.01).
- Supporto per doccia (205.182.01).
- Doccetta anticalcare (1.34.617).
- Flessibile satin (91.34.609.15).

Concealed shower set FLAT

with water shut off and flow control.

- Built-in body included
- Fixed shower head Ø 225 mm. with ball joint. (299.632.01).
- Elbow wall (205.182.01).
- Antilime hand shower (1.34.617).
- Satin hose (91.34.609.15).

Podomítkový jednopákový sprchový set FLAT

s uzávěrem a regulací průtoku.

- Včetně podomítkového tělesa
- Pevná sprcha Ø 225 mm. s kloubem. (299.632.01).
- Držák s nástěnným přívodem vody (205.182.01).
- Ruční sprcha, proti usaz. vod. kamene (1.34.617).
- Flexi hadice SATIN (91.34.609.15).



Cr 204.180.02

KIT SERBATOIO PER VASCHE A MENSOLA

TANK KIT FOR BATH LEDGES

SADA NÁDRŽE PRO STOJÁNKOVÉ VANOVÉ BATERIE

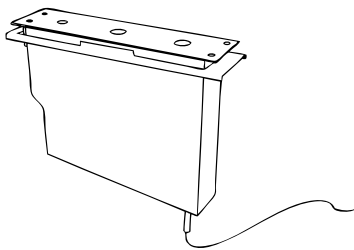

Facilita l'installazione e garantisce la tenuta stagna
Facilitates installation and guarantees water-tightness
Usnadňují instalaci a zaručují těsnost

Il kit serbatoio consente il montaggio superiore del rubinetto a mensola, facilitandone l'installazione. / **The tank kit allows a over-counter tap to be mounted, facilitating its installation** / Sada pro nádrž umožňuje montáž svrchní baterie a usnadňuje její instalaci.

Il sistema di installazione brevettato non ha bisogno di registrazioni. / **The patented installation system requires no valve boxes.** / U patentovaného systému nejsou zapotřebí registrace.

Il serbatoio è a tenuta e comunica con lo scarico della vasca per espellere i resti d'acqua che possono introdursi. / **The tank is watertight and is connected to the bathtub drain, eliminating the water than enters.** / Nádrž je těsná a připojená k odtoku z vany pro evakuaci případných zbytků vody.

Include una placca di ottone cromata estetica per migliorare la finitura della parte visibile. / **Supplied with a brass-plated trim plate to improve the finish of the visible part.** / Zahrnuta je také mosazná pochromovaná deska určená ke zkrášlení viditelné části.

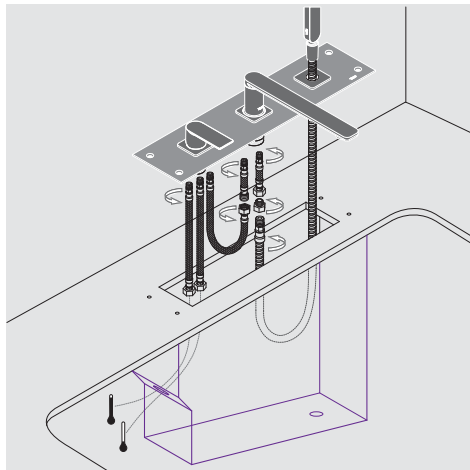



BORDO VASCA / DECK-MOUNTED BATHTUBS / VANY S PRODLOUŽENÝM PULTEM

Ref. / Nr. / Kód:

Monocomando bordo vasca CUADRO
con doccetta anticalcare (006.639.01).

- Portata: 3 bar – 13 l/m.
- Compatibile con il kit serbatoio cod: 200.245.01.
- NOTA: vedere lunghezza canna.







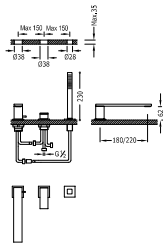

Bath-shower single lever tap for bracket shelf CUADRO
with shower antilime (006.639.01).

- Flowrate: 3 bar – 13 l/m.
- Compatible with tank kit ref: 200.245.01.
- NOTE: see pipe length

Jednopáková stojánková vanová baterie CUADRO

- Sprcha, proti usaz. vod. kamene (006.639.01).
- Průtok: 3 bar – 13 l/m
- Kompatibilní se sadou nádrže ref. č.: 200.245.01.
- POZNÁMKA: viz délka ramínka



	91.30.190 (180 mm.)	
Cr	006.161.06	
	91.30.190 (220 mm.)	
Cr	006.161.04	
	91.30.190 (180 mm.)	
Cr	006.161.05	
	91.30.190 (220 mm.)	
Cr	006.161.03	



Monocomando bordo vasca CLASS
con doccetta anticalcare (299.631.08).

- Portata: 3 bar – 13 l/m.
- Compatibile con il kit serbatoio cod: 200.245.01.
- NOTA: vedere lunghezza canna.

Bath-shower single lever tap for bracket shelf CLASS
with shower antilime (299.631.08).

- Flowrate: 3 bar – 13 l/m.
- Compatible with tank kit ref: 200.245.01.
- NOTE: see pipe length

Jednopáková stojánková vanová baterie CLASS

- Sprcha, proti usaz. vod. kamene (299.631.08).
- Průtok: 3 bar – 13 l/m
- Kompatibilní se sadou nádrže ref. č.: 200.245.01.
- POZNÁMKA: viz délka ramínka

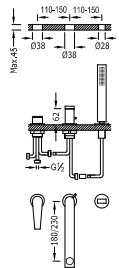

	91.30.190 (180 mm.)	
Cr	205.161.03	
	91.30.190 (230 mm.)	
Cr	205.161.01	

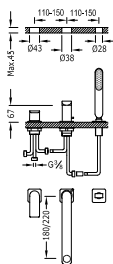

Monocomando bordo vasca LOFT
con doccetta anticalcare (034.639.01).
- Portata: 3 bar - 16 l/m.
- Compatibile con il kit serbatoio cod: 203.245.01.
- NOTA: vedere lunghezza canna.

Bath-shower single lever tap for bracket shelf LOFT
with shower antilime (034.639.01).
- Flowrate: 3 bar - 16 l/m.
- Compatible with tank kit ref: 203.245.01.
- NOTE: see pipe length

Jednopávková stojánková vanová baterie LOFT
Sprcha, proti usaz. vod. kamene (034.639.01).
- Průtok: 3 bar - 16 l/m.
- Kompatibilní se sadou nádrže ref. č.: 203.245.01.
- POZNÁMKA: viz délka ramínka

91.34.591 (180 mm)
Cr 200.162.03

91.34.591 (220 mm)
Cr 200.162.01

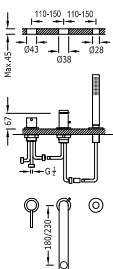

Monocomando bordo vasca MAX
Doccetta anticalcare (034.116.01).
- Portata: 3 bar - 16 l/m.
- Compatibile con il kit serbatoio cod: 203.245.01.
- NOTA: vedere lunghezza canna.

Bath-shower single lever tap for bracket shelf MAX
with shower antilime (034.116.01).
- Flowrate: 3 bar - 16 l/m.
- Compatible with tank kit ref: 203.245.01.
- NOTE: see pipe length

Jednopávková stojánková vanová baterie MAX
Sprcha, proti usaz. vod. kamene (034.116.01).
- Průtok: 3 bar - 16 l/m.
- Kompatibilní se sadou nádrže ref. č.: 203.245.01.
- POZNÁMKA: viz délka ramínka

91.34.591 (180 mm)
Cr 062.161.03

91.34.591 (230 mm)
Cr 062.161.02

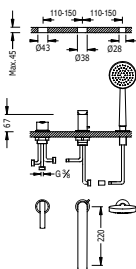

Monocomando bordo vasca LEX
Doccetta massaggio Ø 100 mm. (5 funzioni) (1.34.748).
- Portata: 3 bar - 16 l/m.
- Compatibile con il kit serbatoio cod: 203.245.01.
- NOTA: vedere lunghezza canna.

Bath-shower single lever tap for bracket shelf LEX
Massage hand shower Ø 100 mm. (5 functions) (1.34.748).
- Flowrate: 3 bar - 16 l/m.
- Compatible with tank kit ref: 203.245.01.
- NOTE: see pipe length

Jednopávková stojánková vanová baterie LEX
Ruční masážní sprcha Ø 100 mm. (5 funkcí) (1.34.748).
- Průtok: 3 bar - 16 l/m.
- Kompatibilní se sadou nádrže ref. č.: 203.245.01.
- POZNÁMKA: viz délka ramínka

91.34.591 (180 mm)
Cr 081.161.04

91.34.591 (220 mm)
Cr 081.161.03

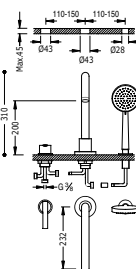

Monocomando bordo vasca LEX
Doccetta massaggio Ø 100 mm. (5 funzioni) (1.34.748).
- Portata: 3 bar - 16 l/m.
- Compatibile con il kit serbatoio cod: 1.89.245.

Bath-shower single lever tap for bracket shelf LEX
Massage hand shower Ø 100 mm. (5 fonctions) (1.34.748).
- Flowrate: 3 bar - 16 l/m.
- Compatible with tank kit ref: 1.89.245.

Jednopávková stojánková vanová baterie LEX
Ruční masážní sprcha Ø 100 mm. (5 funkcí) (1.34.748).
- Průtok: 3 bar - 16 l/m.
- Kompatibilní se sadou nádrže ref. č.: 1.89.245.

91.34.591
Cr 081.150.01

Batteria bordo vasca

- Doccetta anticalcare (034.116.01).
- Portata: 3 bar – 17 l/m.
- Compatibile con il kit serbatoio cod: 1.34.345.

Bath-shower single lever tap for bracket shelf

- Antilime hand shower (034.116.01).
- Flowrate: 3 bar – 17 l/m.
- Compatible with tank kit ref: 1.34.345.

Stojánková vanová baterie

- Ruční sprcha, proti usaz. vod. kamene (034.116.01).
- Průtok: 3 bar – 17 l/m
- Kompatibilní se sadou nádrže ref. č.: 1.34.345.



Cr | 1.63.145



Monocomando bordo vasca ALPLUS

- Doccetta anticalcare (299.631.03).
- Portata: 3 bar – 16 l/m.
- Compatibile con il kit serbatoio cod: 203.245.01.
- NOTA: vedere lunghezza canna.

Bath-shower single lever tap for bracket shelf ALPLUS

- Antilime hand shower (299.631.03).
- Flowrate: 3 bar – 16 l/m.
- Compatible with tank kit ref: 203.245.01.
- NOTE: see pipe length

Jednopávková stojánková vanová baterie ALPLUS

- Sprcha, proti usaz. vod. kamene (299.631.03).
- Průtok: 3 bar – 16 l/m
- Kompatibilní se sadou nádrže ref. č.: 203.245.01.
- POZNÁMKA: viz délka ramínka



Cr | 203.161.02



Cr | 203.161.01

Monocomando bordo vasca CUADRO

- Con bocca a cascata, doccetta anticalcare (006.639.01).
- Portata: 3 bar – 13 l/m.
- Compatibile con il kit serbatoio cod: 1.06.245.

Bath-shower single lever tap for bracket shelf CUADRO

- with cascade cast spout and antilime hand shower (006.639.01).
- Flowrate: 3 bar – 13 l/m.
- Compatible with tank kit ref: 1.06.245.

Jednopávková stojánková vanová baterie CUADRO

- s ramínkem kaskádou. Sprcha, proti usaz. vod. kamene (006.639.01).
- Průtok: 3 bar – 13 l/m
- Kompatibilní se sadou nádrže ref. č.: 1.06.245.



Cr | 1.07.161.02



Cr | 1.06.161.02

Monocomando bordo vasca MAX

- Con bocca a cascata, doccetta anticalcare (034.116.01).
- Portata: 3 bar – 17 l/m.
- Compatibile con il kit serbatoio cod: 1.62.245.

Bath-shower single lever tap for bracket shelf MAX

- with cascade cast spout and antilime hand shower (034.116.01).
- Flowrate: 3 bar – 17 l/m.
- Compatible with tank kit ref: 1.62.245.

Jednopávková stojánková vanová baterie MAX

- s ramínkem kaskádou. Sprcha, proti usaz. vod. kamene (034.116.01).
- Průtok: 3 bar – 17 l/m
- Kompatibilní se sadou nádrže ref. č.: 1.62.245.

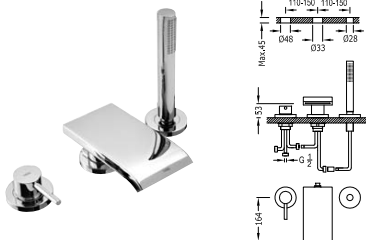

Cr | 061.161.01



Cr | 1.62.161

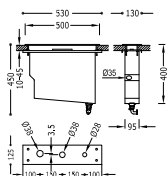

Kit bordo vasca
Facile montaggio superiore. Senza registro (per ref.: 202.161.04, 202.161.02, 202.161.03, 202.161.01, 202.661.02, 202.661.01).

Bath-shower kit cistern
Easy upper assembly, without installation (for Nr.: 202.161.04, 202.161.02, 202.161.03, 202.161.01, 202.661.02, 202.661.01).

Set nádrže pro stojánkové vanové baterie
Snadná montáž shora. Bez otvorů (Kód: 202.161.04, 202.161.02, 202.161.03, 202.161.01, 202.661.02, 202.661.01).

Cr 202.245.01

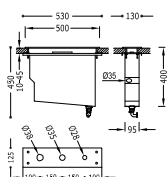

Kit bordo vasca
Facile montaggio superiore. Senza registro (per ref.: 1.07.161.02, 1.06.161.02).

Bath-shower kit cistern
Easy upper assembly, without installation (for Nr.: 1.07.161.02, 1.06.161.02).

Set nádrže pro stojánkové vanové baterie
Snadná montáž shora. Bez otvorů (Kód: 1.07.161.02, 1.06.161.02).

Cr 1.06.245

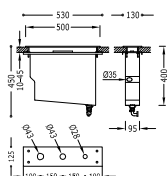

Kit bordo vasca
Facile montaggio superiore. Senza registro (per ref.: 061.161.01, 1.62.161, 261.150.01, 262.150.01).

Bath-shower kit cistern
Easy upper assembly, without installation (for Nr.: 061.161.01, 1.62.161, 261.150.01, 262.150.01).

Set nádrže pro stojánkové vanové baterie
Snadná montáž shora. Bez otvorů (Kód: 061.161.01, 1.62.161, 261.150.01, 262.150.01).

Cr 1.62.245

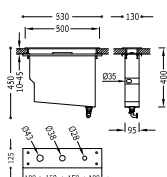

Kit bordo vasca
Facile montaggio superiore. Senza registro (per ref.: 062.161.03, 062.161.02, 200.162.03, 200.162.01, 081.161.04, 081.161.03, 203.161.02, 203.161.01).

Bath-shower kit cistern
Easy upper assembly, without installation (for Nr.: 062.161.03, 062.161.02, 200.162.03, 200.162.01, 081.161.04, 081.161.03, 203.161.02, 203.161.01).

Set nádrže pro stojánkové vanové baterie
Snadná montáž shora. Bez otvorů (Kód: 062.161.03, 062.161.02, 200.162.03, 200.162.01, 081.161.04, 081.161.03, 203.161.02, 203.161.01).

Cr 203.245.01

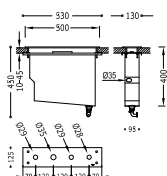

Kit bordo vasca
Facile montaggio superiore. Senza registro (per ref.: 1.63.145, 1.32.145, 1.24.146).

Bath-shower kit cistern
Easy upper assembly, without installation (for Nr.: 1.63.145, 1.32.145, 1.24.146).

Set nádrže pro stojánkové vanové baterie
Snadná montáž shora. Bez otvorů (Kód: 1.63.145, 1.32.145, 1.24.146).

Cr 1.34.345

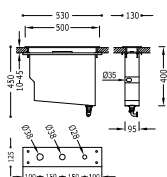

Kit bordo vasca
Facile montaggio superiore. Senza registro (per ref.: 006.161.06, 006.161.04, 006.161.05, 006.161.03, 205.161.03, 205.161.01).

Bath-shower kit cistern
Easy upper assembly, without installation (for Nr.: 006.161.06, 006.161.04, 006.161.05, 006.161.03, 205.161.03, 205.161.01).

Set nádrže pro stojánkové vanové baterie
Snadná montáž shora. Bez otvorů (Kód: 006.161.06, 006.161.04, 006.161.05, 006.161.03, 205.161.03, 205.161.01).

Cr 200.245.01

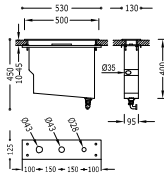

Kit bordo vasca

Facile montaggio superiore. Senza registro (per ref.: 081.150.01).

Bath-shower kit cistern

Easy upper assembly, without installation (for Nr.: 081.150.01).

Set nádrže pro stojánkové vanové baterie

Snadná montáž shora. Bez otvorů (Kód: 081.150.01).

Cr | 1.89.245

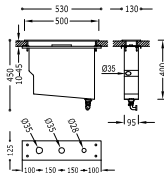

Kit bordo vasca

Facile montaggio superiore. Senza registro (per ref.: 1.42.145.02).

Bath-shower kit cistern

Easy upper assembly, without installation (for Nr.: 1.42.145.02).

Set nádrže pro stojánkové vanové baterie

Snadná montáž shora. Bez otvorů (Kód: 1.42.145.02).

Cr | 1.34.245

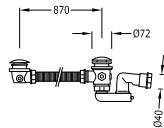

Valvola vasca con presa drenaggio

Bath valve with drainage point

Vanový odpadový ventil

Cr | 1.34.445





PROGRAMMA PER DOCCE SHOWER PROGRAMME SPRCHOVÝ PROGRAM

Doccia / Showers / Sprchy



Docce da soffitto
Showers head
Stropní sprchy



Docce a parete
Wall showers
Nástěnné sprchy



Docce da soffitto
Showers head
Stropní sprchy

Asta antiscivolo / Sliding bar / Posuvná tyč



Asta antiscivolo
Sliding bar
Posuvná tyč



Kit per doccia grande formato
Large-size shower kits
Sprchové soupravy velkých rozměrů



Kit per doccia
Shower kits
Sprchové soupravy

Doccia / Showers / Sprchy



Doccia
Showers
Sprchy



Flessibili
Hoses
Hadice



Docce fisse
Shower arm
Rameno k hubici



Supporti
Supports
Podstavce



Bocchette
Jets
Stimulační trysky Jets



VANTAGGI NELLA DOCCIA BENEFITS IN THE SHOWER VÝHODY PŘI SPRCHOVÁNÍ

Docce da soffitto Showers head Stropní sprchy



Soffione a livello. Design ultrapiatto, ma conservando tutte le caratteristiche di efficienza di una doccia. / **Flush shower head.** Extra flat design, but without renouncing all the efficient characteristics of a shower. / Ploché křepitko. Výjimečně plochý design, který nepřichází o žádné vlastnosti výkonné sprchy.



Bracci snodati. Snodo girevole incorporato in tutti i soffioni per una totale libertà di movimento. / **Ball and socket joint arms.** Rotating ball and socket joint built into all the shower heads, for total freedom of movement. / Tyče s klouby. Otočné klouby, zahrnuté u všech křepítek umožňují naprostou volnost pohybu.

Asta anticivolo Sliding bar Posuvná tyč



Fissaggio regolabile. Sistema di fissaggio a parete scorrevole per sfruttare eventuali fori già esistenti. / **Adjustable anchoring.** Sliding wall mount system, to take advantage of existing holes. / Nastavitelné upevnění. Systém upevnění na stěnu je protiskluzový a umožňuje využití případných škvír či otvorů.



Presa d'acqua. Intelligente soluzione per portare l'acqua senza necessità di ulteriori lavori. / **Water connection.** Intelligent solution for providing the water supply without the need for additional building work. / Přívod vody. Inteligentní řešení přívodu vody bez potřeby provádět další přestavbu.



Supporto orientabile. E con altezza regolabile scorrendo lungo l'asta. / **Adjustable holder.** With an adjustable height thanks to the slide bar. / Otočný držák. S nastavitelnou výškou na tyči.



Deviatore integrato. Devia l'uscita dell'acqua tra la doccia a mano e il soffione o entrambe simultaneamente. / **Built-in inverter.** Switches the water outlet between the hand shower, shower head or both simultaneously. / Zabudovaný invertor. Přepíná výstup vody mezi ruční sprchou a křepítkem a umožňuje její výstup z obou současně.

Doccia Showers Sprchy



Sistema anticalcare. Ugelli di silicone che evitano l'incrostazione del calcare. Facile da pulire con il dito. / **Anti-limescale system. Silicone nozzles to prevent limescale build-up. Easy to clean with your finger.** / Systém proti vodnímu kameni. Silikonové trysky zabraňují usazení vodního kamene. Snadné čištění rukou.

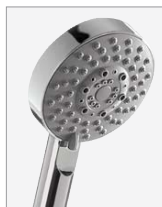

Diverse funzioni. Da una a cinque funzioni: getti massaggianti, stimolanti, effetto pioggia... / **Different functions. From one to five functions: massage jets, toning jets, rain shower effect, and more.** / Rozličné funkce. Od jedné do pěti funkcí: proud masážní, stimulační, déšť...

Flessibili Hoses Hadice

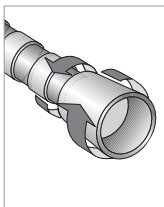

Girevole antitorsione. Sistema antitorsione che permette una rotazione di 360° della doccia, evitando la torsione del tubo flessibile. / **Non-twist system that allows for a 360° rotation of the shower while preventing the hose from twisting.** / Otáčení bez překroucení. Systém proti překroucení umožňuje otočení sprchy o 360°, aniž by došlo k překroucení flexo hadice.



Finitura satinata. Il rivestimento esterno è in materiale sintetico con aspetto cromato. Igienica e facile da pulire. / **Satin finish. The outer layer is a synthetic material with a chrome-plated appearance. Hygienic and easy to clean.** / Saténový povrch. Externí povrch ze syntetického materiálu, chromový vzhled. Hygienický a snadno se čistí.



Attacco universale. L'attacco standard da 1/2" si adatta ad ogni tipo di doccia, di supporto e di rubinetteria. / **Universal intake. The standard 1/2" intake can be used for all types of showers, supports and tapware.** / Univerzálnost. Univerzální napojení 1/2" se přizpůsobí všem typům sprch, držáků a baterií.



Tubo flessibile doppio a incastro. Questo tubo flessibile estremamente resistente evita, in caso di rottura, la comparsa di bordi taglienti. / **Double interlock hose. This very strong hose prevents sharp edges from forming if broken.** / Potažená flexo hadice. Při poškození této vysoce odolné flexo hadice nedojde k vytvoření ostrých hran.

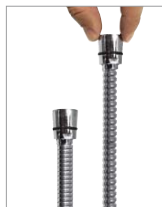

Tubo flessibile inox allungabile. Materiale metallico cromato di alta qualità con la capacità di allungarsi da 1,70 a 2,00 m. / **Extensible stainless steel hose. A high quality chrome metal which can be extended from 1.70 m to 2.00 m.** / Elastická flexo hadice. Vysoce kvalitní chromovaný kovový materiál s možností prodloužení z 1,70 m na 2,00 m.



DOCCE DA SOFFITTO / SHOWERS HEAD / STROPNÍ SPRCHY

Ref. / Nr. / Kód:

Soffione doccia anticalcare
330x330 mm.

Ceiling shower antilime
330x330 mm.

Stropní sprchové křepítko
systém proti usaz. vod. kamene. 330x330 mm.

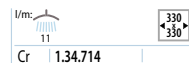
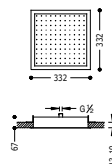
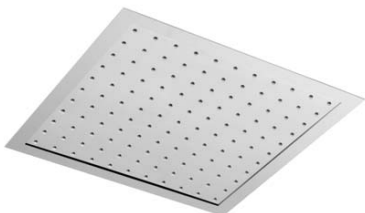

Docce acciaio inossidabile da parete
Anticalcare. 210x550 mm.

Steel Wall showers antilime
210x550 mm.

Nástěnné sprchové křepítko
se systémem proti usaz. vod. kamene 210x550 mm.

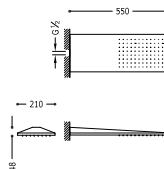

Docce acciaio inossidabile da parete
Anticalcare. 160x550 mm.

Steel Wall showers antilime
160x550 mm.

Nástěnné sprchové křepítko
se systémem proti usaz. vod. kamene 160x550 mm.

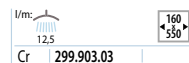
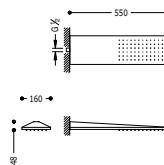

Cr = Cromo/Chrome/Chrom

Soffione doccia anticalcare
Ø 330 mm.

Ceiling shower antilime
Ø 330 mm.

Stropní sprchové křepítko
systém proti usaz. vod. kamene. Ø 330 mm.

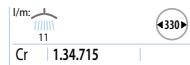
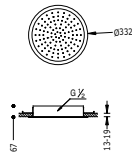

Docce acciaio inossidabile da parete
Anticalcare. 210x550 mm.

Steel Wall showers antilime
210x550 mm.

Nástěnné sprchové křepítko
se systémem proti usaz. vod. kamene 210x550 mm.

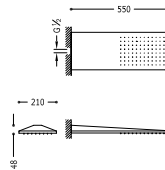

Docce acciaio inossidabile da parete
Anticalcare. 160x550 mm.

Steel Wall showers antilime
160x550 mm.

Nástěnné sprchové křepítko
se systémem proti usaz. vod. kamene 160x550 mm.

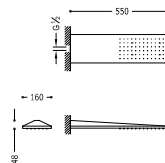

Braccio doccia a soffitto con soffione anticalcare

Ceiling shower arm with antilime shower head

Stropní sprchové ramínko s kropítkem se systémem proti usaz. vod. kamene

		 U/mc 11 Cr 1.34.121	
		 U/mc 11 Cr 1.34.831	
+			 U/mc 12 Cr 299.432.02
		 U/mc 14 Cr 299.432.03	
		 U/mc 16 Cr 299.432.05	



l/m:  11 ◀250▶
Cr | 1.34.221 |



l/m:  11 ◀300▶
Cr | 1.34.331 |



l/m:  15 ◀450▶
Cr | 299.432.04 |

Braccio doccia a parete con soffione anticalcare

Wall shower arm with antilime shower head

Nástěnné sprchové ramínko s kropicítkem se systémem proti usaz. vod. kamene

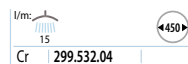
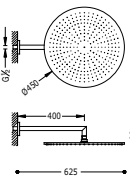
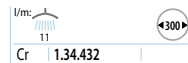
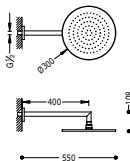
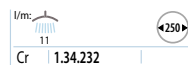
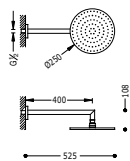
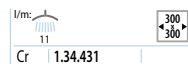
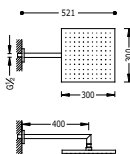
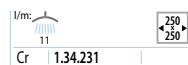
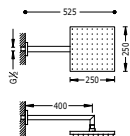

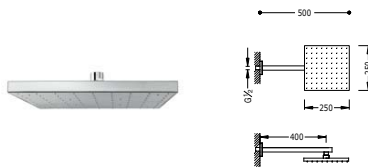

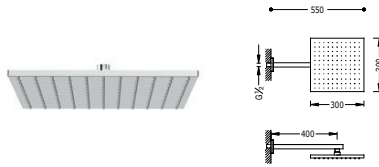

I/m:  11 250
250
Cr | 1.34.233 |

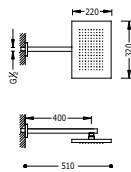

I/m:  11 300
300
Cr | 1.34.433 |



I/m:  12 320
220
Cr | 299.532.02 |

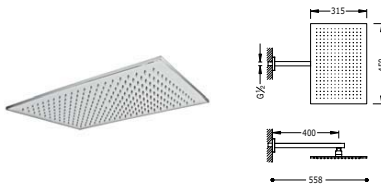

I/m:  14 450
315
Cr | 299.532.03 |

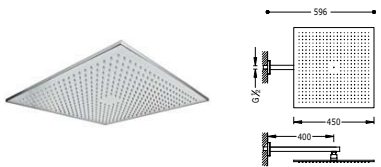

I/m:  16 450
450
Cr | 299.532.05 |

	<p>Soffione doccia anticalcare soffione interamente cromato 200x200 mm.</p> <p>Antilime shower head Full chromed showerhead 200x200 mm.</p> <p>Sprchové kropítko se systémem proti usaz. vod. kamene celochromové 200x200 mm</p>	<p>Cr 299.632.11</p>
	<p>Soffione doccia anticalcare FULL soffione interamente cromato 250x250 mm.</p> <p>Antilime shower head FULL full chromed showerhead 250x250 mm.</p> <p>Sprchové kropítko se systémem proti usaz. vod. kamene FULL celochromové 250x250 mm</p>	<p>Cr 1.34.138.26</p>
	<p>Soffione doccia anticalcare CUB-300 Ottone 300x300 mm.</p> <p>Antilime shower head CUB-300 Brass 300x300 mm.</p> <p>Sprchové kropítko se systémem proti usaz. vod. kamene CUB-300 Materiál Mosaz 300x300 mm</p>	<p>Cr 1.34.138.30</p>
	<p>Soffione doccia anticalcare LOFT-220 soffione interamente cromato 220x220 mm.</p> <p>Antilime shower head LOFT-220 Full chromed showerhead 220x220 mm.</p> <p>Sprchové kropítko se systémem proti usaz. vod. kamene LOFT-220 celochromové 220x220 mm.</p>	<p>Cr 299.632.06</p>
	<p>Soffione doccia anticalcare 320x220 mm.</p> <p>Antilime shower head 320x220 mm.</p> <p>Sprchové kropítko se systémem proti usaz. vod. kamene 320x220 mm.</p>	<p>Cr 299.632.02</p>
	<p>Soffione doccia anticalcare 450x315 mm.</p> <p>Antilime shower head 450x315 mm.</p> <p>Sprchové kropítko se systémem proti usaz. vod. kamene 450x315 mm.</p>	<p>Cr 299.632.03</p>

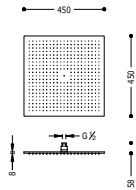

Soffione doccia anticalcare
450x450 mm.

Antilime shower head
450x450 mm.

Sprchové kropítko se systémem proti usaz. vod. kamene
450x450 mm.



Cr | 299.632.05

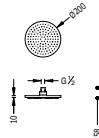

Soffione doccia anticalcare
soffione interamente cromato Ø 200 mm.

Antilime shower head
Full chromed showerhead Ø 200 mm.

Sprchové kropítko se systémem proti usaz. vod. kamene
celochromové Ø 200 mm



Cr | 299.632.12

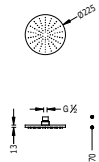

Soffione doccia anticalcare LEX-225
soffione interamente cromato Ø 225 mm.

Antilime shower head LEX-225
Full chromed showerhead Ø 225 mm.

Sprchové kropítko se systémem proti usaz. vod. kamene
LEX-225
celochromové Ø 225 mm



Cr | 299.632.01

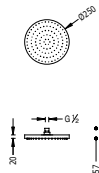

Soffione doccia anticalcare FULL
soffione interamente cromato Ø 250 mm.

Antilime shower head FULL
full chromed showerhead Ø 250 mm.

Sprchové kropítko se systémem proti usaz. vod. kamene
FULL
celochromové Ø 250 mm



Cr | 1.34.137.26

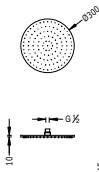

Soffione doccia anticalcare MAX-300
Ottone Ø 300 mm.

Antilime shower head MAX-300
Brass Ø 300 mm.

Sprchové kropítko se systémem proti usaz. vod. kamene
Materiál Mosaz Ø 300 mm



Cr | 1.34.137.30

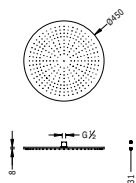

Soffione doccia anticalcare
Ø 450 mm.

Antilime shower head
Ø 450 mm.

Hubice se systémem proti vzniku vodního kamene
Ø 450 mm.

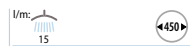

Cr | 299.632.04

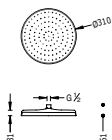

Soffione doccia anticalcare CLASIC/RETRO
Ø 310 mm.

Antilime shower head CLASIC/RETRO
Ø 310 mm.

Sprchové kropítko se systémem proti usaz. vod. kamene
CLASIC/RETRO
Ø 310 mm.

I/m:	11	310
Cr	299.337.03	
Lv	299.337.03.LV	

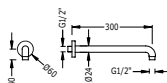

Braccio doccia
per soffione doccia lungo 300 mm.

Shower bar holder
for shower spout long. 300 mm.

Nástěnné rameno
na sprchové kropítko délka 300 mm

Cr 1.34.621.01

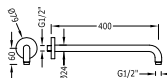

Braccio doccia
per soffione doccia lungo 400 mm.

Shower bar holder
for shower spout long. 400 mm.

Nástěnné rameno
na sprchové kropítko délka 400 mm

Cr 1.34.621.04

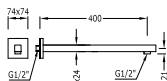

Braccio doccia
per soffione doccia

Shower bar holder
for shower spout

Nástěnné rameno
na sprchové kropítko

Cr 1.34.139.40

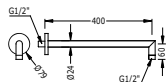

Braccio doccia
per soffione doccia

Shower bar holder
for shower spout

Nástěnné rameno
na sprchové kropítko

Cr 1.61.187.40

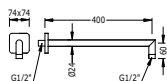

Braccio doccia
per soffione doccia

Shower bar holder
for shower spout

Nástěnné rameno
na sprchové kropítko

Cr 299.639.02

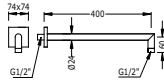

Braccio doccia
per soffione doccia

**Shower bar holder
for shower spout**

Nástěnné rameno
na sprchové křížátko

Cr | 062.432.01

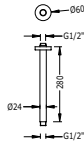

Braccio tetto
per soffione doccia

**Ceiling arm
for shower spout**

Stropní rameno
na sprchové křížátko

Cr | 1.34.621.02

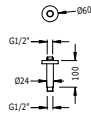

Braccio tetto
per soffione doccia

**Ceiling arm
for shower spout**

Stropní rameno
na sprchové křížátko

Cr | 1.34.521.02

N

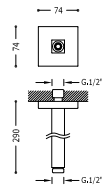

Braccio tetto
per soffione doccia

**Ceiling arm
for shower spout**

Stropní rameno
na sprchové křížátko

Cr | 1.34.622.02

N

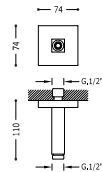

Braccio tetto
per soffione doccia

**Ceiling arm
for shower spout**

Stropní rameno
na sprchové křížátko

Cr | 1.34.522.02



Ref./Nr./Kód:



Asta anticivolo PROJECT

Ottone lungo 659 mm.
Ottone lungo 909 mm.

Sliding bar PROJECT

Brass long, 659 mm.
Brass long, 909 mm.

Posuvná tyč PROJECT

Materiál Mosaz, délka 659 mm
Materiál Mosaz, délka 909 mm

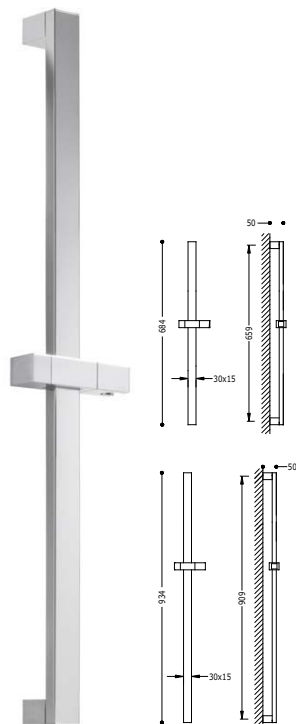

	(659 mm.)	
Cr	1.34.516	
	(909 mm.)	
Cr	1.34.517	

ASTA ANTISCIVOLO / SLIDING BAR / POSUVNÁ TYČ

Ref. / Nr. / Kód:

Asta antiscivolo CUADRO-SLIM
Ottone lungo 663 mm.
Ottone lungo 900 mm.

Sliding bar CUADRO-SLIM
Brass long. 663 mm.
Brass long. 900 mm.

Posuvná tyč CUADRO-SLIM
Materiál Mosaz, délka 663 mm
Materiál Mosaz, délka 900 mm

Asta antiscivolo CUADRO
Ottone lungo 842 mm.

Sliding bar CUADRO
Brass long. 842 mm.

Posuvná tyč CUADRO
Materiál Mosaz, délka 842 mm

Asta antiscivolo LOFT
Ø 14 mm. Longo 800 mm.

Sliding bar LOFT
Ø 14 mm. long. 800 mm.

Posuvná tyč LOFT
Ø 14 mm, délka 800 mm

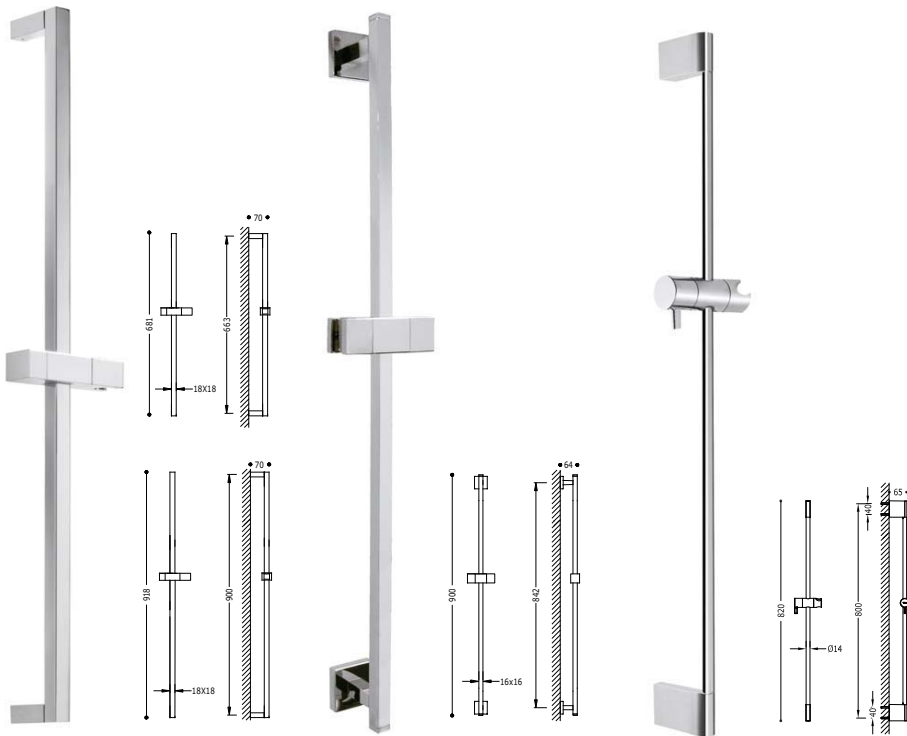

	(663 mm.)
Cr	1.07.922
	(900 mm.)
Cr	1.34.520

	(842 mm.)
Cr	1.07.935

	(800 mm.)
Cr	034.637.01

Asta anticivolo MINIMAL

Ø 19 mm. Longo 550 mm.
Ø 19 mm. Longo 850 mm.

Sliding bar MINIMAL

Ø 19 mm. long. 550 mm.
Ø 19 mm. long. 850 mm.

Posuvná tyč MINIMAL

Ø 19 mm, délka 550 mm
Ø 19 mm, délka 850 mm

Asta anticivolo MAX-MINI

Ø 20,6 mm. Longo 624 mm.

Sliding bar MAX-MINI

Ø 20,6 mm. long. 624 mm.

Posuvná tyč MAX-MINI

Ø 20,6 mm, délka 624 mm

Asta anticivolo

Ø 20,6 mm. Longo 762 mm.

Sliding bar

Ø 20,6 mm. long. 762 mm.

Posuvná tyč

Ø 20,6 mm, délka 762 mm



	(550 mm.)
Cr	1.34.618
	(850 mm.)
Cr	1.34.619

	(624 mm.)
Cr	034.637.02

	(762 mm.)
Cr	034.637.08



Asta antiscivolo PRACTIC-MAX

Ø 20,6 mm. Lungo 516 mm. con 2 supporti di fissaggio regolabili.

Ø 20,6 mm. Lungo 816 mm. con 2 supporti di fissaggio regolabili.

Sliding bar PRACTIC-MAX

Ø 20,6 mm. long. 516 mm. with 2 adjustable fixing bracket.

Ø 20,6 mm. long. 816 mm. with 2 adjustable fixing bracket.

Posuvná tyč PRACTIC-MAX

Ø 20,6 mm, délka 516 mm Se 2 nastavitelnými upínacími nosníky.

Ø 20,6 mm, délka 816 mm Se 2 nastavitelnými upínacími nosníky.

Asta antiscivolo LUXUS

Ø 25 mm. Lungo 578 mm.

Sliding bar LUXUS

Ø 25 mm. long. 578 mm.

Posuvná tyč LUXUS

Ø 25 mm, délka 578 mm

Asta antiscivolo ECO

Ø 25 mm. Lungo 614 mm.

Sliding bar ECO

Ø 25 mm. long. 614 mm.

Posuvná tyč ECO

Ø 25 mm, délka 614 mm



	(516 mm.)
Cr	1.61.835
	(816 mm.)
Cr	1.61.838

	(578 mm.)
Cr	1.34.835

	(614 mm.)
Cr	1.43.835

Asta antiscivolo ARC
Longo 669 mm.

Sliding bar ARC
long. 669 mm.

Posuvná tyč ARC
délka 669 mm

Asta antiscivolo RETRO
Ø 18 mm. Longo 548 mm.

Sliding bar RETRO
Ø 18 mm. long. 548 mm.

Posuvná tyč RETRO
Ø 18 mm. délka 548 mm

Asta antiscivolo FASHION
Ø 20,6 mm. Longo 673 mm.

Sliding bar FASHION
Ø 20,6 mm. long. 673 mm.

Posuvná tyč FASHION
Ø 20,6 mm, délka 673 mm

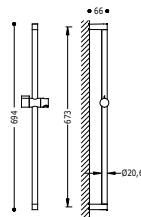
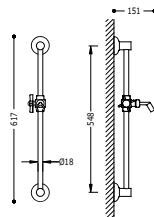
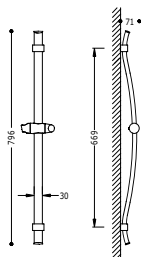

	(669 mm.)
Cr	1.34.737

	(548 mm.)
Cr	1.34.732
Lv	5.34.732.01
Ac	5.34.732.03

	(673 mm.)
Cr	034.637.06

KIT PER DOCCIA / SHOWER KITS / SPRCHOVÉ SOUPRAVY

Ref./Nr./Kód:

Kit anticalcare PROJECT-SLIM
Ottone lungo 659 mm. Flessibile satin
Ottone lungo 909 mm. Flessibile satin

Bar-shower antilime PROJECT-SLIM
Brass long. 659 mm. Satin hose
Brass long. 909 mm. Satin hose

Sprchová souprava, proti usaz. vod. kamene
PROJECT-SLIM

Materiál Mosaz, délka 659 mm Flexi hadice SATIN
Materiál Mosaz, délka 909 mm Flexi hadice SATIN

Kit anticalcare PROJECT
Ottone lungo 659 mm. Flessibile satin
Ottone lungo 909 mm. Flessibile satin

Bar-shower antilime PROJECT
Brass long. 659 mm. Satin hose
Brass long. 909 mm. Satin hose

Sprchová souprava, proti usaz. vod. kamene
PROJECT

Materiál Mosaz, délka 659 mm Flexi hadice SATIN
Materiál Mosaz, délka 909 mm Flexi hadice SATIN

Kit anticalcare CUADRO-SLIM
Ottone lungo 663 mm. Flessibile satin
Ottone lungo 900 mm. Flessibile satin

Bar-shower antilime CUADRO-SLIM
Brass long. 663 mm. Satin hose
Brass long. 900 mm. Satin hose

Sprchová souprava, proti usaz. vod. kamene
CUADRO-SLIM

Materiál Mosaz, délka 663 mm Flexi hadice SATIN
Materiál Mosaz, délka 900 mm Flexi hadice SATIN

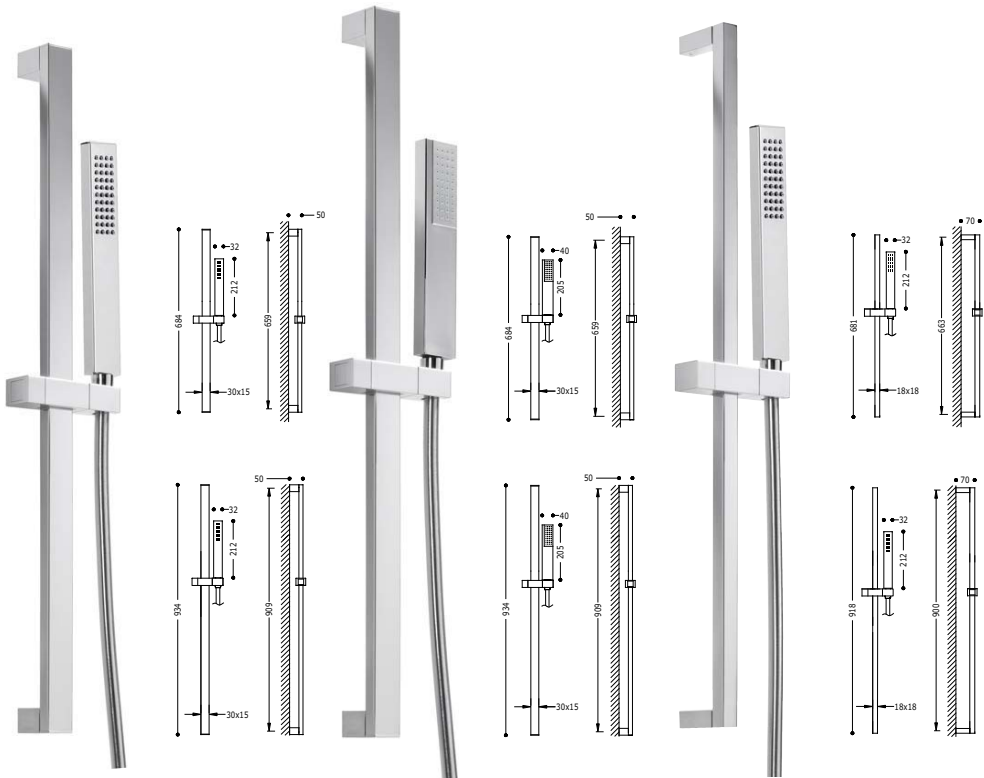

l/m: \varnothing	9.5
	(659 mm.)
Cr	034.526.02
	(909 mm.)
Cr	034.527.02

l/m: \varnothing	16
	(659 mm.)
Cr	1.34.526
	(909 mm.)
Cr	1.34.527

l/m: \varnothing	9.5
	(663 mm.)
Cr	034.336.03
	(900 mm.)
Cr	034.336.04

Kit anticalcare CUADRO
Ottone lungo 842 mm. Flessibile satin

Bar-shower antilime CUADRO
Brass long. 842 mm. Satin hose

Sprchová souprava, proti usaz. vod. kamene CUADRO
Materiál Mosaz, délka 842 mm. Flexi hadice SATIN

Kit anticalcare CUADRO-MINI
Ottone lungo 663 mm. Flessibile satin
Ottone lungo 900 mm. Flessibile satin

Bar-shower antilime CUADRO-MINI
Brass long. 663 mm. Satin hose
Brass long. 900 mm. Satin hose

Sprchová souprava, proti usaz. vod. kamene CUADRO-MINI
Materiál Mosaz, délka 663 mm Flexi hadice SATIN
Materiál Mosaz, délka 900 mm Flexi hadice SATIN

Kit anticalcare LOFT
Ø 14 mm. Longo 800 mm. Flessibile satin

Bar-shower antilime LOFT set
Ø 14 mm. long. 800 mm. Satin hose

Sprchová souprava, proti usaz. vod. kamene LOFT
Ø 14 mm, délka 800 mm Flexi hadice SATIN

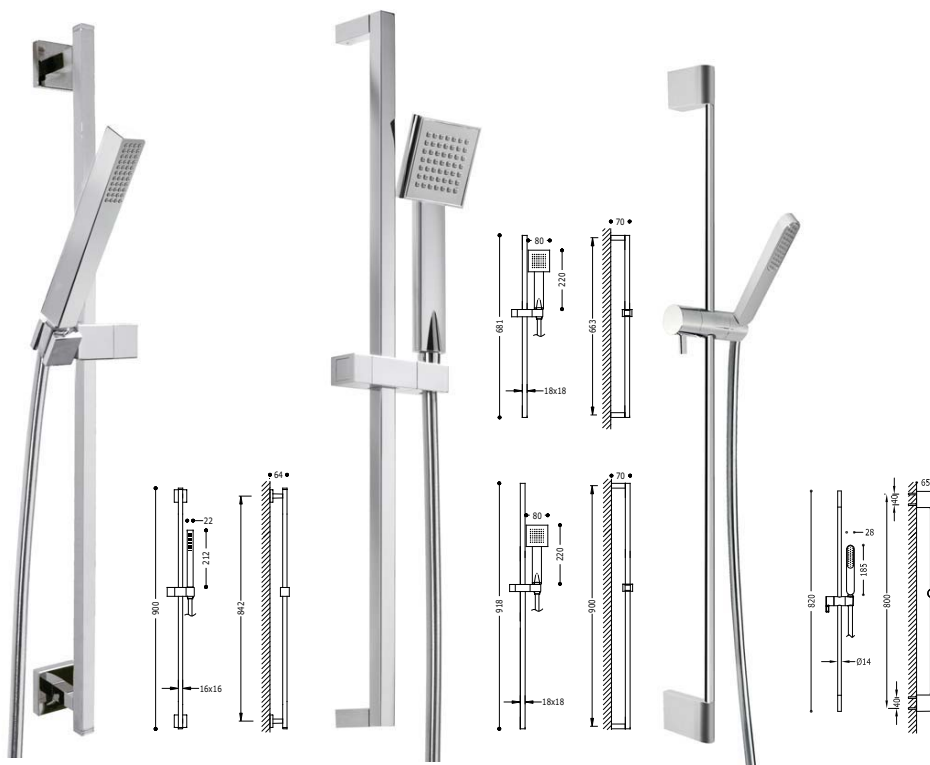

I/m:	9.5	(842 mm.)
Cr	1.07.934	
	6.07.934	
	4.07.934	

I/m:	15	(663 mm.)
Cr	1.34.512	
		(900 mm.)
Cr	1.34.522	

I/m:	13	(800 mm.)
Cr	034.336.01	



Kit anticalcare FASHION

Ø 20,6 mm. Longo 673 mm. Flessibile satin

Bar-shower antilime FASHION

Ø 20,6 mm. Long. 673 mm. Satin hose

Sprchová souprava, proti usaz. vod. kamene FASHION

Ø 20,6 mm, délka 673 mm. Flexi hadice SATIN

Asta antiscivolo

Ø 19 mm. Longo 850 mm. Flessibile satin

Sliding bar

Ø 19 mm. long. 850 mm. Satin hose

Sprchová sada

Ø 19 mm, délka 850 mm Flexi hadice SATIN

Asta antiscivolo

Ø 19 mm. Longo 850 mm. Flessibile satin

Sliding bar

Ø 19 mm. long. 850 mm. Satin hose

Sprchová sada

Ø 19 mm, délka 850 mm Flexi hadice SATIN



l/m: 10 (673 mm.)
Cr 034.637.07



l/m: 9,5 (850 mm.)
Cr 034.629.02

l/m: 10 (850 mm.)
Cr 061.928.01

Kit MINIMAL

Ø 19 mm. Longo 550 mm. Flessibile satin
 Ø 19 mm. Longo 850 mm. Flessibile satin

Bar-shower MINIMAL set

Ø 19 mm. Long. 550 mm. Satin hose
 Ø 19 mm. Long. 850 mm. Satin hose

Sprchová sada MINIMAL

Ø 19 mm, délka 550 mm Flexi hadice SATIN
 Ø 19 mm, délka 850 mm Flexi hadice SATIN

Kit anticalcare AQUA PLUS

Ø 20,6 mm. Longo 516 mm. Flessibile satin

Bar-shower antilime AQUA PLUS

Ø 20,6 mm. Long. 516 mm. Satin hose

Sprchová souprava, proti usaz. vod. kamene AQUA PLUS

Ø 20,6 mm, délka 516 mm. Flexi hadice SATIN

Kit massaggio PLUS

Ø 25 mm. Longo 578 mm. Flessibile satin

Bar-shower massage PLUS set

Ø 25 mm. long. 578 mm. Satin hose

Masážní sada PLUS

Ø 25 mm, délka 578 mm Flexi hadice SATIN



l/m:						100
	16	16.5	15.5	16	11	
	(550 mm.)					
Cr	1.34.628					
	(850 mm.)					
Cr	1.34.629					

l/m:		100
	10	
	(516 mm.)	
Cr	061.849.02	

l/m:				82
	11	8	6	
	(578 mm.)			
Cr	1.34.923			

Kit massaggio ECO

Ø 25 mm. Longo 614 mm. Flessibile satin

Bar-shower massage ECO set

Ø 25 mm. long. 614 mm. Satin hose

Masážní sada ECO

Ø 25 mm, délka 614 mm Flexi hadice SATIN

Asta anticivolo

Ø 20,6 mm. Longo 575 mm. Flessibile satin. Con presa a parete

Ø 20,6 mm. Longo 966 mm. Flessibile satin. Con presa a parete

Sliding bar

Ø 20,6 mm. Long. 575 mm. Satin hose. With wall entrance

Ø 20,6 mm. Long. 966 mm. Satin hose. With wall entrance

Sprchová sada

Ø 20,6 mm, délka 575 mm Flexi hadice SATIN s nástěnným přívodem

Ø 20,6 mm, délka 966 mm Flexi hadice SATIN s nástěnným přívodem

Asta anticivolo

Ø 20,6 mm. Longo 575 mm. Flessibile satin. Con presa a parete

Ø 20,6 mm. Longo 966 mm. Flessibile satin. Con presa a parete

Sliding bar

Ø 20,6 mm. Long. 575 mm. Satin hose. With wall entrance

Ø 20,6 mm. Long. 966 mm. Satin hose. With wall entrance

Sprchová sada

Ø 20,6 mm, délka 575 mm Flexi hadice SATIN s nástěnným přívodem

Ø 20,6 mm, délka 966 mm Flexi hadice SATIN s nástěnným přívodem



l/m:	80
15 7 (614 mm.)	
Cr	1.43.836

l/m:	110
10 (575 mm.)	
Cr	061.931.03
Cr	061.931.05

l/m:	75
9,5 (575 mm.)	
Cr	061.931.02
Cr	061.931.04

KIT PER DOCCIA GRANDE FORMATO / LARGE-SIZE SHOWER KITS / SPRCHOVÉ SOUPRAVY VELKÝCH ROZMĚRŮ

Ref. / Nr. / Kód:

Set monocomando con doccia CUADRO

Doccia fissa 250x250 mm. Doccetta anticalcare e flessibile satin

Bar-shower CUADRO set

Fixed shower head 250x250 mm. Antilime hand shower and sateen hose. Adaptable to a bath and shower mixer

Sprchová souprava, proti usaz. vod. kamene CUADRO

Pevná sprcha 250x250 mm. Flexi hadice SATIN. Ruční sprcha, proti usaz. vod. kamene. Přizpůsobitelná na celek baterie sprchy a vany-sprchy

Set monocomando con doccia CUADRO

Doccia fissa 250x250 mm. Douchette anticalcaire e flessibile satin. Con presa a parete

Bar-shower CUADRO set

Fixed shower head 250x250 mm. Antilime hand shower and sateen hose. With wall entrance

Sprchová souprava, proti usaz. vod. kamene CUADRO

Pevná sprcha 250x250 mm. Ruční sprcha, proti usaz. vod. kamene Flexi hadice SATIN. S nástěnným přívodem

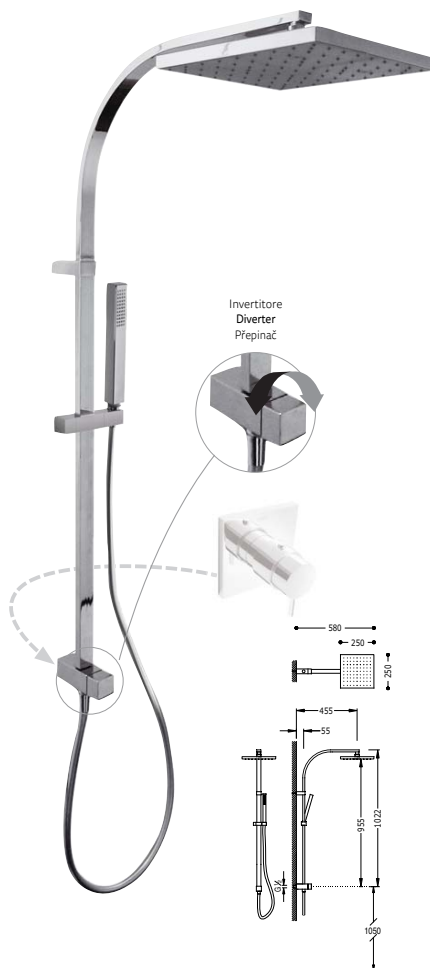
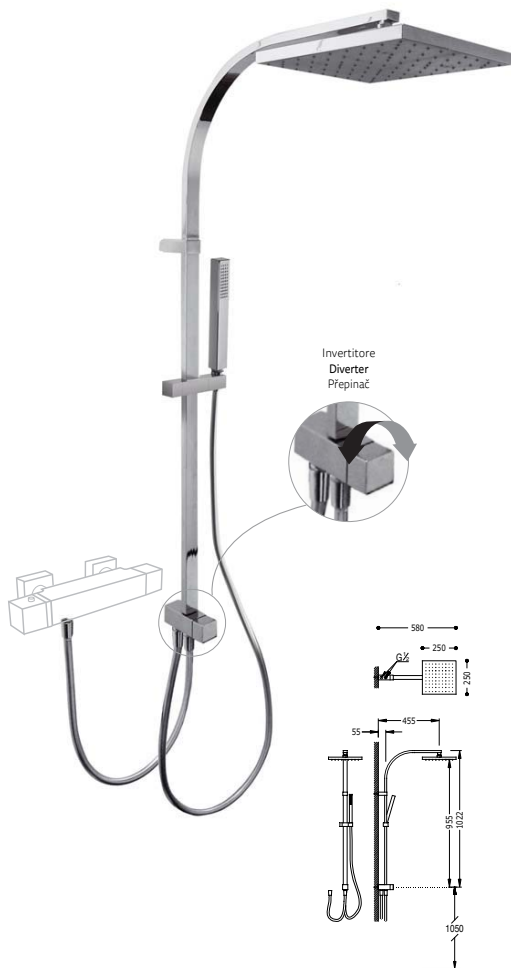

l/m: 9.5 Cr 1.07.926



l/m: 9.5 Cr 1.07.131

Set monocomando con doccia CUADRO

Doccia fissa 250x250 mm. Doccetta anticalcare e flessibile satin

Bar-shower CUADRO set

Fixed shower head 250x250 mm. Antilime hand shower and sateen hose. Adaptable to a bath and shower mixer

Sprchová souprava, proti usaz. vod. kamene CUADRO

Pevná sprcha 250x250 mm. Flexi hadice SATIN. Ruční sprcha, proti usaz. vod. kamene. Přizpůsobitelná na celek baterie sprchy a vany-sprchy

Set monocomando con doccia RETRO

Doccia fissa Ø 310 mm. Doccetta anticalcare.

Bar-shower RETRO set

Fixed shower head Ø 310 mm. Antilime hand shower. Adaptable to a bath and shower mixer

Sprchová souprava, proti usaz. vod. kamene RETRO

Pevná sprcha Ø 310 mm. Ruční sprcha, proti usaz. vod. kamene. Přizpůsobitelná na celek baterie sprchy a vany-sprchy

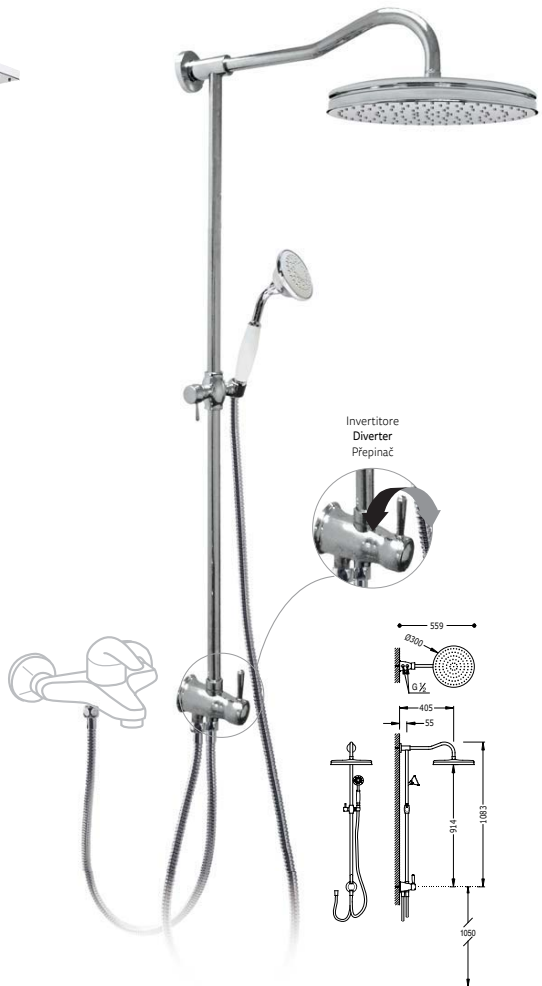
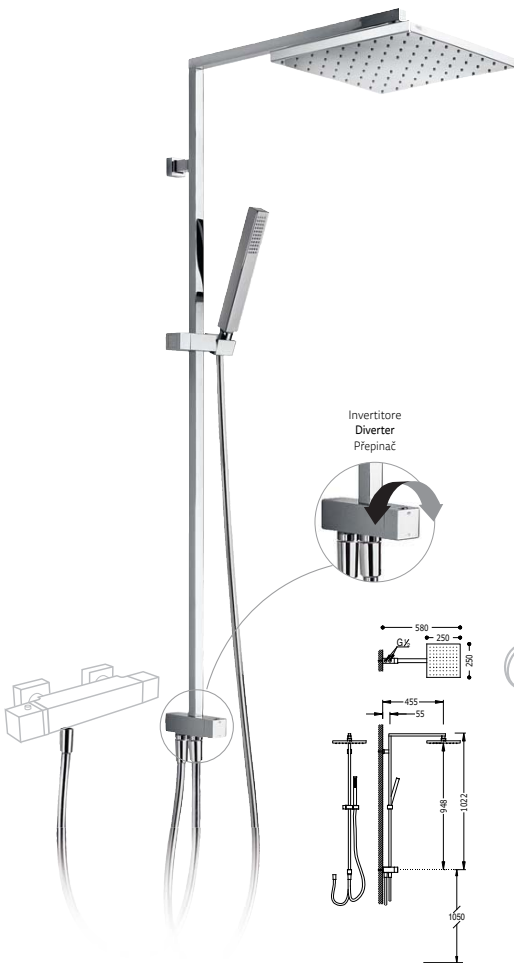

l/mc 9.5
Cr | 1.07.476

l/mc 13
Cr | 024.476.01

Set monocomando con doccia ECO-TERM
 Doccia fissa Ø 225 mm. Doccetta Ø 100 mm. (5 funzioni).

Bar-shower ECO-TERM set

Fixed shower head Ø 225 mm. Massage hand shower Ø 100 mm. (5 fonctions) and saateen hose. Adaptable to a bath and shower mixer

Sprchová tyč ECO-TERM

Pevná sprcha Ø 225 mm. Flexi hadice SATIN. Ruční masážní sprcha Ø 100 mm. (5 funkci). Přizpůsobitelná na celek baterie sprchy a vany-sprchy

Set monocomando con doccia ECO-TERM

Doccia fissa Ø 225 mm. Doccetta Ø 100 mm. (5 funzioni). Flessibile satin. Con presa a parete

Bar-shower ECO-TERM set

Fixed shower head Ø 225 mm. Massage hand shower Ø 100 mm. (5 fonctions) and saateen hose. With wall entrance

Sprchová tyč ECO-TERM

Pevná sprcha Ø 225 mm. Flexi hadice SATIN. Ruční masážní sprcha Ø 100 mm. (5 funkci). S nástěnným privodem

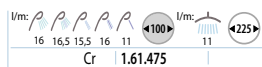

Kit massaggio

Doccia fissa Ø 250 mm. Doccetta Ø 100 mm. (5 funzioni) e flessibile satin.

Bar-shower massage set

Fixed shower head Ø 250 mm. Massage hand shower Ø 100 mm. (5 functions) and sateen hose. Adaptable to a bath and shower mixer

Tyč pro masážní sprchu

Pevná sprcha Ø 250 mm. Flexi hadice SATIN. Ruční masážní sprcha Ø 100 mm. (5 funkci). Přizpůsobitelná na celek baterie sprchy a vany-sprchy

Set doccia massaggio

Doccia fissa Ø 250 mm. Doccetta massaggio Ø 100 mm (5 posizioni). Flessibile satin. Con presa a parete

Bar-shower massage set

Fixed shower head Ø 250 mm. Massage hand shower Ø 100 mm. (5 positions) and sateen hose. With wall entrance

Tyč pro masážní sprchu

Pevná sprcha Ø 250 mm. Flexi hadice SATIN. Ruční masážní sprcha Ø 100 mm. (5 funkci). S nástěnným přívodem

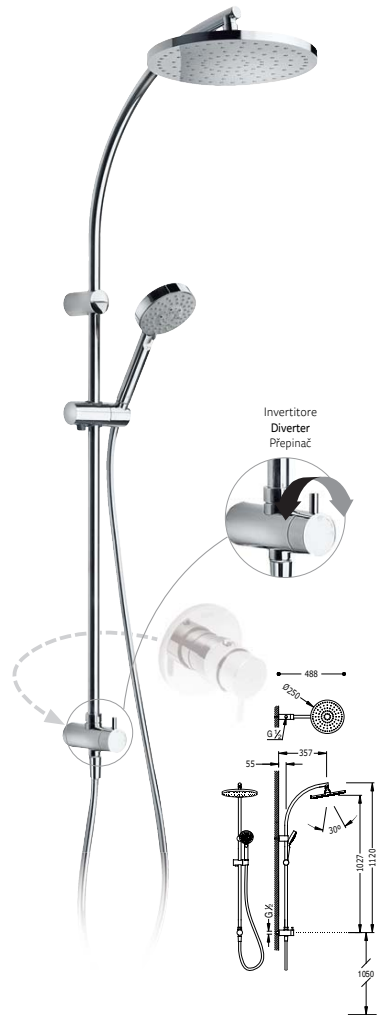

Set doccia

Barra e supporti parete regolabili. Doccia fissa Ø 250 mm. Doccetta massaggi Ø 100 mm (5 posizioni). Flessibile satin.

Bar-shower set

Sliding wall holder. Fixed shower head Ø 250 mm. Massage hand shower Ø 100 mm (5 positions). Sateen hose. Adaptable to a bath and shower mixer.

Sprchová souprava, proti usaz. vod. kamene

Posuvná tyč na nástěnných držácích. Pevná sprcha Ø 250 mm. Ruční masážní sprcha Ø 100 mm (5 funkcí). Flexi hadice SATIN. Přizpůsobitelná na celek baterie sprchy a vany-sprchy.

Set doccia

Barra e supporti parete regolabili. Doccia fissa 250x250 mm. Doccetta anticalcare. Flessibile satin.

Bar-shower set

Sliding wall holder. Fixed shower head 250x250 mm. Antilime shower. Sateen hose. Adaptable to a bath and shower mixer.

Sprchová souprava, proti usaz. vod. kamene

Posuvná tyč na nástěnných držácích. Pevná sprcha 250x250 mm. Sprcha, proti usaz. vod. kamene. Flexi hadice SATIN. Přizpůsobitelná na celek baterie sprchy a vany-sprchy.

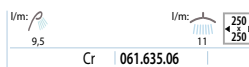
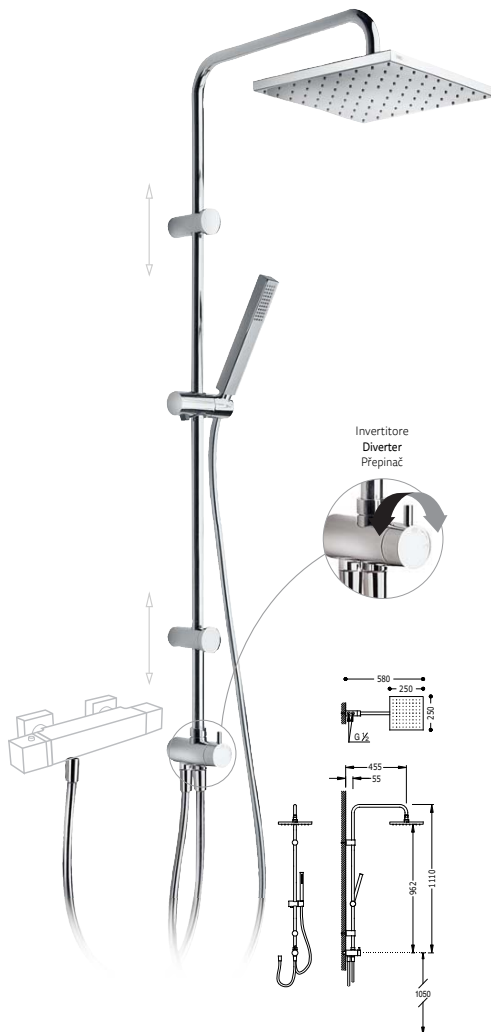
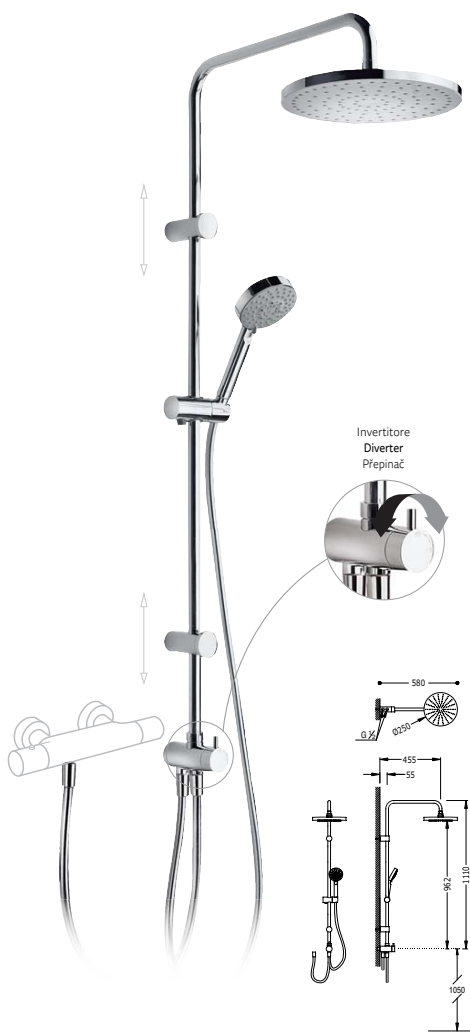

Set doccia

Barra e supporti parete regolabili. Doccia fissa Ø 300 mm. Ottone. Doccetta massaggio Ø 100 mm (5 posizioni). Flessibile satin.

Bar-shower set

Sliding wall holder. Fixed shower head Ø 300 mm. Brass. Massage hand shower Ø 100 mm (5 positions). Sateen hose. Adaptable to a bath and shower mixer.

Sprchová souprava, proti usaz. vod. kamene

Posuvná tyč na nástěnných držácích. Pevná sprcha Ø 300 mm. Materiál mosaz. Ruční masážní sprcha Ø 100 mm (5 poloh). Flexi hadice SATIN. Přizpůsobitelná na celek baterie sprchy a vany-sprchy.

Set doccia

Barra e supporti parete regolabili. Doccia fissa 300x300 mm. Ottone. Doccetta anticalcare. Flessibile satin.

Bar-shower set

Sliding wall holder. Fixed shower head 300x300 mm. Brass. Antilime shower. Sateen hose. Adaptable to a bath and shower mixer.

Sprchová souprava, proti usaz. vod. kamene

Posuvná tyč na nástěnných držácích. Pevná sprcha 300x300 mm. Materiál mosaz. Sprcha, proti usaz. vod. kamene. Flexi hadice SATIN. Přizpůsobitelná na celek baterie sprchy a vany-sprchy.

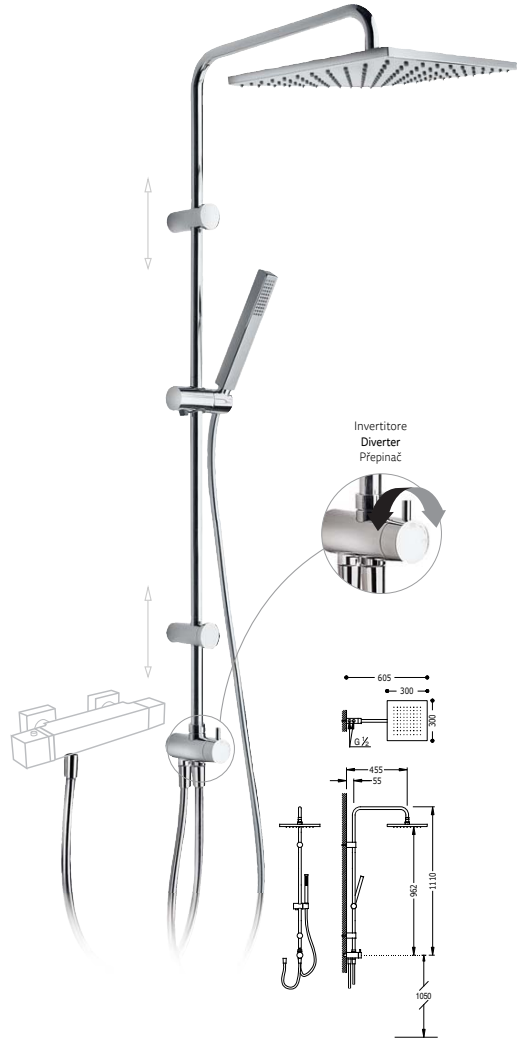
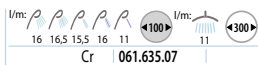
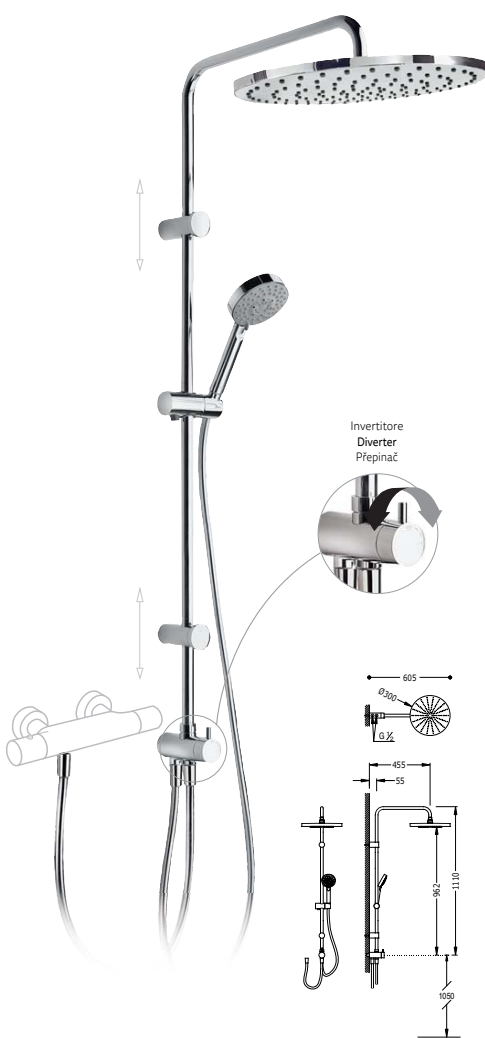

Set doccia

Doccia fissa 200x200 mm. Doccetta anticalcare. Flessibile doppia graffatura. Ad incasso.

Bar-shower set

fixed shower head 200x200 mm. Antilime hand shower. Double interlocked shower hose. Adaptable to a bath and shower mixer.

Sprchová souprava, proti usaz. vod. kamene

Pevná sprcha 200x200 mm. Sprcha, proti usaz. vod. kamene. Flexi hadice s dvojitým opletem

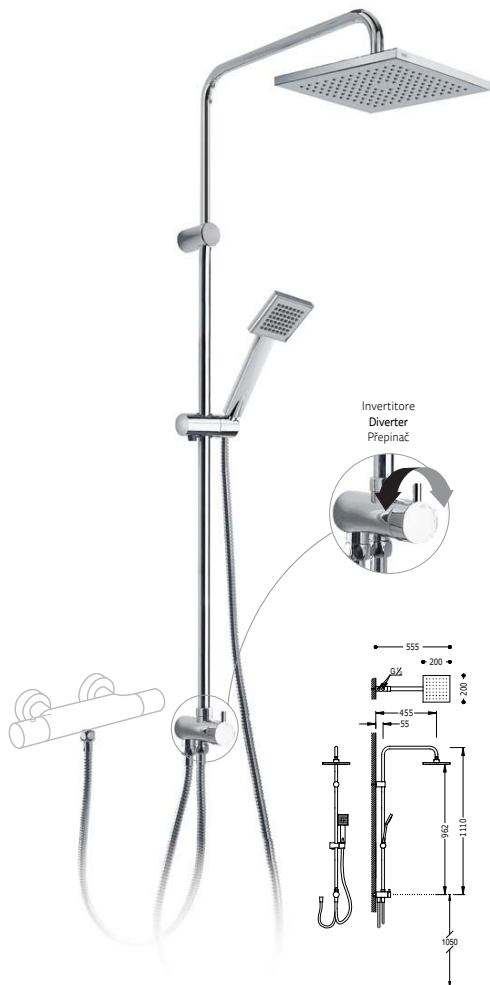

Set doccia

Doccia fissa Ø 250 mm. Doccetta Ø 100 mm. (5 funzioni) e manichetta satinata

Telescopic shower kit

fixed shower head Ø 250 mm. Massage hand shower Ø 100 mm (5 fonctions), and sateen hose

Sprchová souprava, proti usaz. vod. kamene

Pevná sprcha Ø 250 mm. Flexi hadice SATIN. Ruční masážní sprcha Ø 100 mm (5 funkcí). Výsuvná. S rozdělovačem

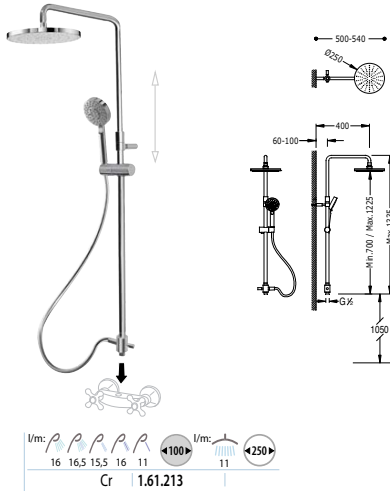

Set doccia

Doccia fissa Ø 225 mm. Doccetta anticalcare Ø 100 mm. e manichetta satinata

Telescopic shower kit

fixed shower head Ø 225 mm. Antilime hand shower Ø 100 mm. and sateen hose

Sprchová souprava, proti usaz. vod. kamene

Pevná sprcha Ø 225 mm. Flexi hadice SATIN. Ruční sprcha, proti usaz. vod. kamene Ø 100 mm. Výsuvná. S rozdělovačem

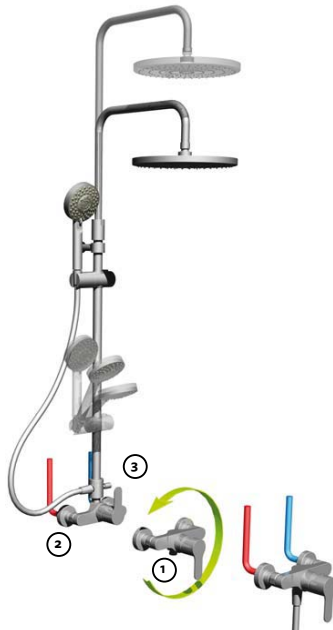
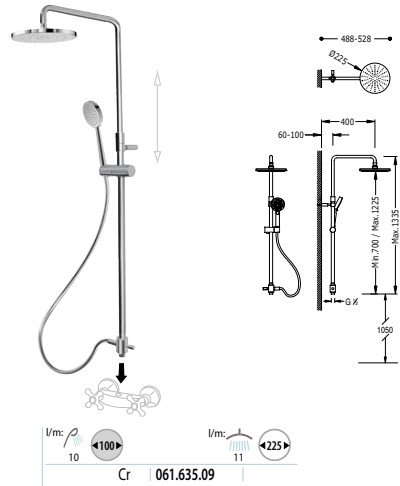

Installazione / Installation / Instalace





DOCCIA / SHOWERS / SPRCHY

Ref. / Nr. / Kód:

Doccetta anticalcare CLASS

Antilime shower CLASS

Sprcha, proti usaz. vod. kamene CLASS

Doccia PROJECT

Shower PROJECT

Sprcha, proti usaz. vod. kamene PROJECT

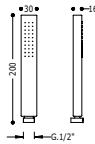

I/m: 12
Cr | 299.631.08

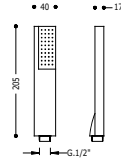

I/m: 16
Cr | 1.34.611

Doccetta anticalcare LOFT

Antilime shower LOFT

Sprcha, proti usaz. vod. kamene LOFT

Doccia TUB

Ø 24 Ottone

Shower TUB

Ø 24 mm. Brass

Sprcha TUB

Ø 24 mm. Materiál Mosaz

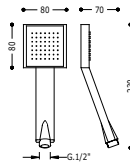

I/m: 15
Cr | 1.34.612

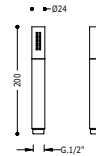

I/m: 12
Cr | 91.34.123.80

Doccia tubo WC

Ø 24 mm. Ottone (per ref.: 34.122, 34.123, 81.122, 81.123, 81.222, 81.223, 62.122, 62.123)

Shower WC

Ø 24 mm. Brass (for Nr.: 34.122, 34.123, 81.122, 81.123, 81.222, 81.223, 62.122, 62.123)

Trubková sprška pro WC

Ø 24 mm. Materiál mosaz. S omezovacím hrdlem s I/m. SYSTÉM PROTI KAPÁNÍ (pro ref. č. 34.122, 34.123, 81.122, 81.123, 81.222, 81.223, 62.122, 62.123)

Doccetta con chiusura e flessibile satinato

(per ref.: 81.113, 61.113, 203.113.01)

Handshower with locking

(for Nr.: 81.113, 61.113, 203.113.01)

Sprcha s uzávěrem

(pro ref. č. 81.113, 61.113, 203.113.01)

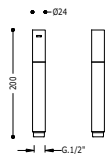

I/m: 5
Cr | 91.34.123.90

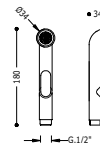

I/m: 8
Cr | 299.113.51

Doccetta massaggio

5 tipi di getto

Massage shower

5 jet types

Masážní sprcha

5 typů proudění vody

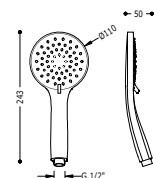

Doccetta anticalcare

Antilime shower

Sprcha, proti usaz. vod. kamene

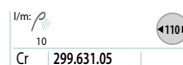
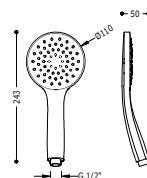

Doccia LEX-100

5 tipi di getto

Shower LEX-100

5 jet types

Sprcha LEX-100

5 typů proudění vody

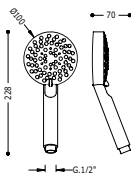

Doccetta anticalcare

Antilime shower

Sprcha, proti usaz. vod. kamene

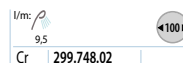
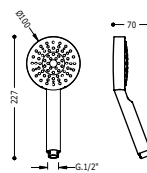

Doccetta massaggio PAUSA

3 tipi di getto Riduzione di portata

Massage shower PAUSA

3 jet types. Flow water reduction

Masážní sprcha PAUSA

3 typů proudění vody s redukcí na minimální průtok při stisku možnosti STOP-TRES, pomocí níž se zabrání opětovnému stupňování

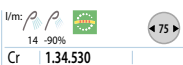
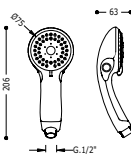

Doccetta anticalcare PAUSA

2 tipi di getto Riduzione di portata

Antilime shower PAUSA

2 jet types. Flow water reduction

Sprcha, proti usaz. vod. kamene PAUSA

2 typů proudění vody s redukcí na minimální průtok při stisku možnosti STOP-TRES, pomocí níž se zabrání opětovnému stupňování

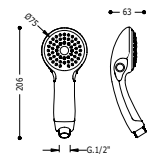

Doccetta anticalcare
Antilime shower
Sprcha, proti usaz. vod. kamene

Doccetta anticalcare ECO-ANTICAL
Antilime shower ECO-ANTICAL
Sprcha ECO-ANTICAL

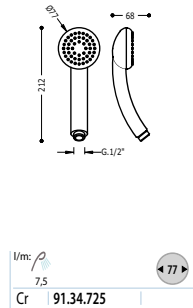
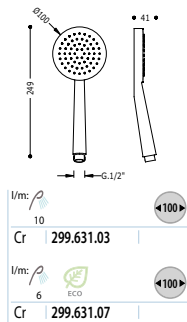

Doccetta massaggio AQUA PLUS
2 tipi di getto
Massage shower AQUA PLUS
2 jet types

Masážní sprcha AQUA PLUS
2 typů proudění vody

Doccetta anticalcare AQUA
Antilime shower AQUA
Sprcha, proti usaz. vod. kamene AQUA

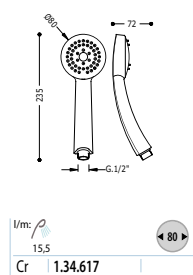
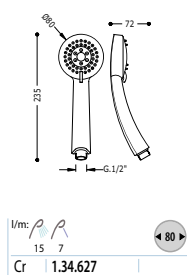

Doccetta massaggio PLUS
3 tipi di getto
Massage shower PLUS
3 jet types

Masážní sprcha PLUS
3 typů proudění vody

Doccetta anticalcare PLUS
Antilime shower PLUS
Sprcha, proti usaz. vod. kamene PLUS

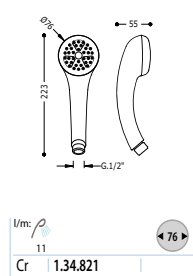
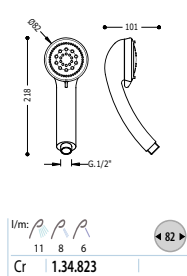

Doccetta anticalcare CONFORT
cambia il colore della luce a seconda della temperatura (senza batterie)

Antilime shower CONFORT
change light colour according to the temperature

Sprcha, proti usaz. vod. kamene CONFORT
Ukazuje teplotu vody pomocí barvy světla (bez baterii)

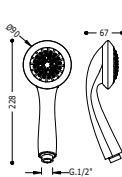

I/m: 9
Cr 1.34.802



0° - 32°



32° - 42°



42° - 65°

90

Doccia anticalcare RETRO

Antilime shower RETRO

Sprcha, proti usaz. vod. kamene RETRO

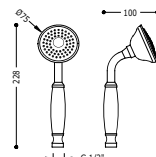

I/m: 13

Cr 1.24.824
Lv 5.24.824.01
Ac 5.24.824.03

75

Doccetta anticalcare CLASIC-TRES

Antilime shower CLASIC-TRES

Sprcha, proti usaz. vod. kamene CLASIC-TRES

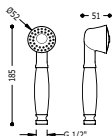

I/m: 15

Cr 91.34.824
Lv 91.34.824.05.1
Ac 91.34.824.05.3

52

Doccia ORDAL antica

gomito antico

Shower ORDAL
former elbow

Starobylá sprcha ORDAL
starobylé kolínko



I/m: 26,5

91.34.825.10

60

Doccia lavastoviglie

(per ref.: 41.443, 50.443, 70.443.38, 73.443.02)

Extractible shower two positions

(for Nr.: 41.443, 50.443, 70.443.38, 73.443.02)

Sprška na mytí nádob

(pro ref. č. 41.443, 50.443, 70.443.38, 73.443.02)

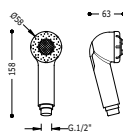

I/m: 12 12

Cr 91.34.880

58

Doccia lavastoviglie

(per ref.: 30.444, 41.444, 44.444, 72.443, 73.443, 73.444, 039.444.01, 069.444.01)

Extractible shower two positions

(for Nr.: 30.444, 41.444, 44.444, 72.443, 73.443, 73.444, 039.444.01, 069.444.01)

Ruční sprcha k dřezové baterii

(pro ref. č. 30.444, 41.444, 44.444, 72.443, 73.443, 73.444, 039.444.01, 069.444.01)

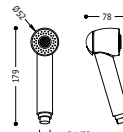

I/m: 12 12

Cr 91.34.849

52

Doccia monocomando parrucchiera

Shower hairdresser's shop

Jednopáková sprchová baterie pro kadeřnictví

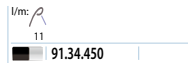
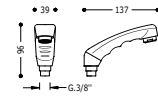

DOCCE FISSE / SHOWER ARM / RAMENO K HUBICI

Braccio doccia massaggio PLUS
con regolatore di portata, 3 posizioni

Massage shower arm PLUS
flow regulation, 3 positions

Sprchové rameno ECO masáž PLUS
s regulátorem průtoku o 3 polohách

Braccio doccia massaggio PLUS

Shower head PLUS

Hlava sprchového ramene PLUS

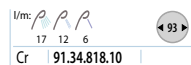
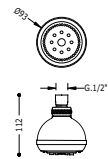
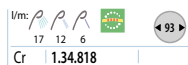
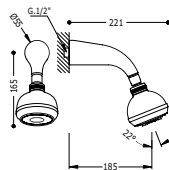

Braccio doccia ECO
Shower arm ECO
Sprchové rameno ECO

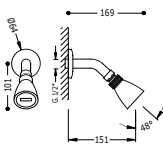

U/m: 37
Cr | 1.34.738 |

Braccio doccia ECO
Shower head ECO
Hlava sprchového ramena ECO

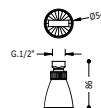

U/m: 37
Cr | 91.34.738.10 |

Braccio doccia ORDAL
Shower arm ORDAL
Sprchové rameno ORDAL

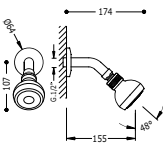

U/m: 22
Cr | 1.34.808 |

Braccio doccia ORDAL
Shower head ORDAL
Hlava sprchového ramena ORDAL

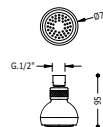

U/m: 22
Cr | 91.34.808.10 |

Gomito parete ECO
Shower bar holder ECO
Nástěnné kolínko ECO

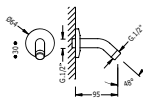

Cr | 1.34.738.50 |

BOCCHETTE / JETS / STIMULAČNÍ TRYSKY JETS

Ref. / Nr. / Kód:

Bocchetta incassata di idromassaggio con 1 tipo di getto orientabile. Include un sistema anticalcare, valvola antiritorno e limitatore di flusso: 5 l/m. Ø 130 mm.

Hydromassage built-in jet with 1 type of adjustable stream. Includes anti-limescale system, check valve and flow restrictor: 5 L/m. Ø 130 mm.

Zapuštěná hydromasážní tryska s 1 typem natáčecího proudu. Má systém proti usazování kamence, zpětný ventil a omezovač průtoku: 5 l/min. Ø 130 mm.

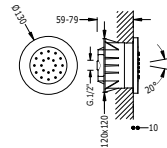

l/m: 5
Cr **91.61.515**

Bocchetta incassata di idromassaggio con 1 tipo di getto orientabile. Include un sistema anticalcare, valvola antiritorno e limitatore di flusso: 5 l/m. 125x125 mm.

Hydromassage built-in jet with 1 type of adjustable stream. Includes anti-limescale system, check valve and flow restrictor: 5 L/m. 125x125 mm.

Zapuštěná hydromasážní tryska s 1 typem natáčecího proudu. Má systém proti usazování kamence, zpětný ventil a omezovač průtoku: 5 l/min. 125x125 mm.

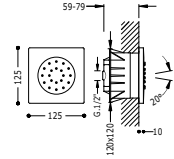
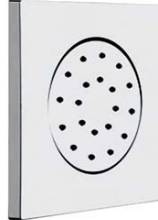

l/m: 5,25
Cr **91.07.515**

Doccia laterale a idromassaggio con 1 tipo di getto orientabile. Include un sistema anticalcare, valvola antiritorno e limitatore di flusso: 5 l/m. Materiale Ottone.

Hydromassage side shower with 1 type of adjustable stream. Includes anti-limescale system, check valve and flow restrictor: 5 L/m. Brass.

Boční hydromasážní sprcha s 1 typem natáčecího proudu. Má systém proti usazování kamence, zpětný ventil a omezovač průtoku: 5 l/min. Materiál mosaz.

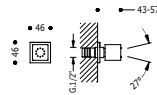

l/m: 5
Cr **91.34.515**

Doccia laterale a idromassaggio con 1 tipo di getto orientabile. Include un sistema anticalcare, valvola antiritorno e limitatore di flusso: 5 l/m. Materiale Ottone.

Hydromassage side shower with 1 type of adjustable stream. Includes anti-limescale system, check valve and flow restrictor: 5 L/m. Brass.

Boční hydromasážní sprcha s 1 typem natáčecího proudu. Má systém proti usazování kamence, zpětný ventil a omezovač průtoku: 5 l/min. Materiál mosaz.

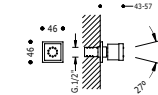

l/m: 5
Cr **299.515.01**

Doccia laterale a idromassaggio con 1 tipo di getto orientabile. Include un sistema anticalcare, valvola antiritorno e limitatore di flusso: 5 l/m. Materiale Ottone.

Hydromassage side shower with 1 type of adjustable stream. Includes anti-limescale system, check valve and flow restrictor: 5 L/m. Brass.

Boční hydromasážní sprcha s 1 typem natáčecího proudu. Má systém proti usazování kamence, zpětný ventil a omezovač průtoku: 5 l/min. Materiál mosaz.

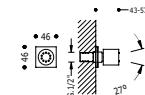

l/m: 5
Cr **299.515.03**

Doccia laterale a idromassaggio con 1 tipo di getto orientabile. Include un sistema anticalcare, valvola antiritorno e limitatore di flusso: 5 l/m. Materiale Ottone.

Hydromassage side shower with 1 type of adjustable stream. Includes anti-limescale system, check valve and flow restrictor: 5 L/m. Brass.

Boční hydromasážní sprcha s 1 typem natáčecího proudu. Má systém proti usazování kamence, zpětný ventil a omezovač průtoku: 5 l/min. Materiál mosaz.

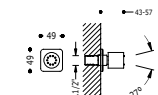

l/m: 5
Cr **299.515.02**

Doccia laterale a idromassaggio
con 1 tipo di getto orientabile. Include un sistema anticalcare, valvola antiritorno e limitatore di flusso: 5 l/m. Materiale Ottone.

Hydromassage side shower
with 1 type of adjustable stream. Includes anti-limescale system, check valve and flow restrictor: 5 L/m. Brass.

Boční hydromasážní sprcha
s 1 typem natáčecího proudu. Má systém proti usazování kamence, zpětný ventil a omezovač průtoku: 5 l/min. Materiál mosaz.

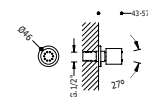

l/m:	5
Cr	91.34.415

Doccia laterale a idromassaggio
2 funzioni 6 l/m. - 4,5 l/m.

Hydromassage side shower
2 positions 6 ltr./m., 4,5 ltr./m.

Boční hydromasážní sprcha
ABS, 2 funkce 6 l/m a 4,5 l/m

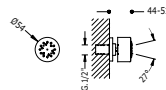

l/m:	6 4,5
Cr	91.34.915

Doccia laterale a idromassaggio
1 funzione 4 l/m.

Hydromassage side shower
1 position 4 ltr./m.

Boční hydromasážní sprcha
ABS, 1 funkce 4 l/m

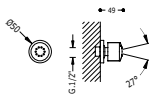

l/m:	4
Cr	91.34.615

FLESSIBILI / HOSES / HADICE

Ref. / Nr. / Kód:

Flessibile satinato
Ø 14,5 mm. Girevole antitorsione

Shower hose Satin
Ø 14,5 mm.

Hadice SATIN
Ø 14,5 mm. Otočná, se systémem proti překroucení

Flessibile INOX ESTENSIBILE 1,70 m
Ø 14 mm.

Shower hose INOX EXTENSIBILE 1,70 m.
Ø 14 mm.

Hadice OCEL EXTENSIBILE s prodloužením 1,70 m
Ø 14 mm.



R1/2"

R1/2"

	(750 mm.)	
St	91.34.609.10	
	(1.200 mm.)	
St	91.34.609.12	
	(1.500 mm.)	
St	91.34.609.15	
	(1.700 mm.)	
St	91.34.609	
	(2.000 mm.)	
St	91.34.609.20	



R1/2"

R1/2"

Inox | 91.34.630

Flessibile doppia graffatura 1,70 m.
Filettatura conica con giunto torico e rosetta integrata nel raccordo. Garanzia 10 anni
Double interlocked shower hose 1,70 m.
Conical nut with ring seal and bolt washer in adapter. Ten-year warranty

Hadice s dvojitým zámkem 1,70 m
kónická matice s těsnícím kroužkem a blokovacím mezikroužkem v přechodce. Záruka deset let

Flessibile 1,70 m.
Hose 1,70 m.
Hadice 1,70 m.



R1/2"

R1/2"

ESTENSIBILE / EXTENSIBLE / EXTENSIBLE

Cr	91.34.828	
Inox	91.34.830.80	



R1/2"

R1/2"

Lv	91.34.830.05.1	
Co	91.34.830.05.2	
Ac	91.34.830.05.3	

Flessibile doppia graffatura 1,25 m.
Ø 12 mm. (per ref.: 30.444, 41.443, 41.444, 44.444, 50.443, 52.444, 54.444, 70.443, 72.443, 73.443, 73.444, 39.444, 69.444)

Double interlocked shower hose 1,25 m.
Ø 12 mm. (for Nr.: 30.444, 41.443, 41.444, 44.444, 50.443, 52.444, 54.444, 70.443, 72.443, 73.443, 73.444, 39.444, 69.444)

Hadice s dvojitým zámkem 1,25 m
Ø 12 mm. (pro ref. č. 30.444 41.443, 41.444, 44.444, 50.443, 52.444, 54.444, 70.443, 72.443, 73.443, 73.444)

Flessibile 1,70 m.
Ø 12 mm. (per ref.: 30.430, 30.432, 30.433, 14.444, 43.444, 87.444, 130.460, 62.438, 30.452, 81.438)

Hose 1,70 m.
Ø 12 mm. (for Nr.: 30.430, 30.432, 30.433, 14.444, 43.444, 87.444, 130.460, 62.438, 30.452, 81.438)

Hadice 1,70 m pro dřezovou baterii
Ø 12 mm. (pro ref. č. 30.430, 30.432, 30.433, 14.444, 43.444, 87.444, 130.460, 62.438, 30.452, 81.438)



M15x1

R1/2"

Cr | 91.34.867



M15x1

Ø18x2,5

Cr | 91.34.712

Flessibile doppia graffatura 1,70 m.

Double interlocked shower hose 1,70 m.

Hadice s dvojitým zámkom 1,70 m

per kit bordo vasca / for bath and shower mixer / pro stojánk van. baterii (per ref.: 06.161, 07.161, 14.150, 17.145, 39.145, 41.145, 43.145, 43.147, 44.145, 61.150, 61.161, 61.181, 62.150, 62.161, 63.145, 63.181, 69.145, 72.145, 73.145, 74.145, 85.145, 87.150, 87.161, 87.181, 89.150, 70.145, 81.150, 81.161, 89.161, 200.161, 200.162, 202.161, 202.661, 203.161, 205.161, 261.150, 262.150)



M15x1

R1/2"

Cr 91.34.881

Flessibile metallico 1,50 m.

(per ref.: 145 CLASICTRES, MONOCLASIC 1900, RETROTRES)

Shower hose 1,50 m.

(for Nr.: 145 CLASICTRES, MONOCLASIC 1900, RETROTRES)

Kovová flexi hadice 1,50 m

(pro ref. č. 145 CLASICTRES, MONOCLASIC 1900, RETROTRES)



M15x1

M15x1

Cr 91.34.731
Lv 91.34.731.05.1

Flesso modello parrucchieria 1,30 m.

3/8" - 3/8" (per ref.: 72.450)

Shower hose single lever mixer hairdresser's shop 1,30 m.

3/8" - 3/8" (for Nr.: 72.450)

Hadice pro kadeřnickou baterii 1,30 m

3/8" vnější závit 3/8" vnitřní závit (pro ref. č. 72.450)



R3/8"

R3/8"

91.34.887

Supporto per doccia
con presa a parete

**Shower holder
with wall entrance**

Úchyt ruční sprchy se stěnovou přípojkou vody
s nástěnným vodním přívodem

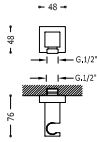

Cr 006.182.01
Ac 006.182.01.AC

Supporto per doccia
con presa a parete

**Shower holder
with wall entrance**

Úchyt ruční sprchy se stěnovou přípojkou vody
s nástěnným vodním přívodem

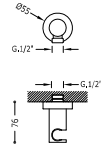

Cr 205.182.01

Supporto per doccia
con presa a parete

**Shower holder
with wall entrance**

Úchyt ruční sprchy se stěnovou přípojkou vody
s nástěnným vodním přívodem

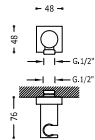

Cr 061.182.01

Supporto per doccia
con presa a parete

**Shower holder
with wall entrance**

Úchyt ruční sprchy se stěnovou přípojkou vody
s nástěnným vodním přívodem

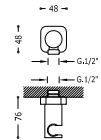

Cr 200.182.01

Supporto per doccia
con presa a parete

**Shower holder
with wall entrance**

Úchyt ruční sprchy se stěnovou přípojkou vody
s nástěnným vodním přívodem

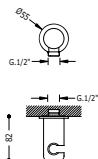

Cr 024.182.01

SUPPORTI / SUPPORTS / PODSTAVCE

Ref. / Nr. / Kód:

Supporto orientabile
Ottone

Adjustable holder
Brass

Nastavitelný čtvercový držák, kovový
Materiál Mosaz

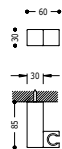

Cr	1.07.839	
Ac	5.07.839.03	

Supporto orientabile
Ottone

Adjustable holder
Brass

Nastavitelný kulatý držák, kovový
Materiál Mosaz

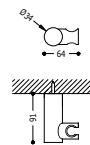

Cr	1.61.839	
Ac	5.61.839.03	

Supporto orientabile
Adjustable holder
Nastavitelný držák

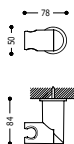

Cr	299.639.01	
Bl	91.34.839.00.4	

Supporto orientabile
Ottone

Adjustable holder
Brass

Nastavitelný držák
Materiál Mosaz



Cr	91.34.832	
Lv	91.34.832.50.1	

Supporto fisso
Fixed holder
Pevný držák

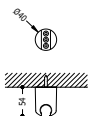

Cr	91.34.841	
----	-----------	--

Supporto fisso
con due posizioni. Per tutti i flessi

Fixed holder
with two positions for all the hoses

Pevný držák
s 2 polohami pro všechny flexi hadice

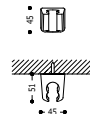

Cr	91.34.848	
----	-----------	--

GOMITI / ELBOWS / KOLENA

Angolo presa parete flessibile
presa acqua 1/2"

Wall elbow adapter for shower hose
water supply connection 1/2"

Kolínko nástěnným přívodem pro flexi hadici
přívod vody 1/2"



Cr 1.34.757

Angolo presa parete flessibile
presa acqua 1/2"

Wall elbow adapter for shower hose
water supply connection 1/2"

Kolínko nástěnným přívodem pro flexi hadici
přívod vody 1/2"

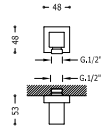

Cr 006.183.01
Ac 006.183.01.AC

Angolo presa parete flessibile
presa acqua 1/2"

Wall elbow adapter for shower hose
water supply connection 1/2"

Kolínko nástěnným přívodem pro flexi hadici
přívod vody 1/2"

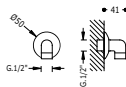

Cr 1.34.873

Angolo presa parete flessibile
presa acqua 1/2"

Wall elbow adapter for shower hose
water supply connection 1/2"

Kolínko nástěnným přívodem pro flexi hadici
přívod vody 1/2"

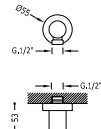

Cr 205.183.01

Angolo presa parete flessibile
presa acqua 1/2"

Wall elbow adapter for shower hose
water supply connection 1/2"

Kolínko nástěnným přívodem pro flexi hadici
přívod vody 1/2"

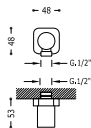

Cr 200.183.01

Angolo presa parete flessibile
presa acqua 1/2"

Wall elbow adapter for shower hose
water supply connection 1/2"

Kolínko nástěnným přívodem pro flexi hadici
přívod vody 1/2"

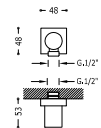

Cr 061.183.01



PORTASAPONE / OTHER / OSTATNÍ

Ref. / Nr. / Kód:

Portasapone LEX
per asta antiscivolo Ø 20,5 mm. (per ref.: 1.81.821, 1.81.921)

Soap dish LEX
for sliding bar Ø 20,5 mm. (for Nr.: 1.81.821, 1.81.921)

Mýdlenka LEX
na posuvnou tyč Ø 20,5 mm. (pro ref. č. 1.81.821, 1.81.921)



Cr+Meta: 91.81.921.05

Portasapone
per asta antiscivolo Ø 18 mm. - Ø 24 mm. e colonna doccia AVAN-TRES

Soap dish
for sliding bar LUXUS Ø 18 mm. - Ø 24 mm.

Mýdlenka
na posuvnou tyč Ø 18 mm a Ø 24 mm a panely AVAN-TRES



Cr 1.34.637
Meta 5.34.637.05

Portasapone CUB
per asta antiscivolo Ø 18 mm. - Ø 24 mm.

Soap dish CUB
for sliding bar Ø 18 mm. - Ø 24 mm.

Mýdlenka CUB
pro tyč Ø 18 mm a Ø 24 mm



Cr 91.87.195.10

Portasapone DOUBLE
per asta antiscivolo Ø 18 mm. - Ø 24 mm.

Soap dish DOBLE
for sliding bar Ø 18 mm. - Ø 24 mm.

Mýdlenka DOBLE
pro tyč Ø 18 mm a Ø 24 mm



Cr 91.61.195.10

Portasapone LUXUS
per asta antiscivolo Ø 25 mm.

Soap dish LUXUS
for sliding bar Ø 25 mm.

Mýdlenka LUXUS
pro tyč Ø 25 mm



Cr+Meta: 91.34.735

Prolunghe
Extensions
Prodlužka

Prolunghe
Extensions
Prodlužka

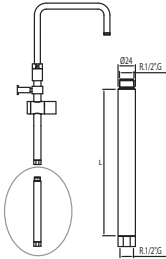

1
(per ref. / for Nr. / Kód: 90.312, 90.311, 90.310, 90.212, 90.211, 90.210, 90.213, 90.214, 87.355, 87.356, 024.164.04)

L= 300 mm.	Cr	91.81.195.03
L= 650 mm.	Cr	1.81.195.02

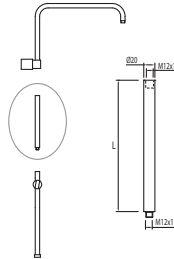

1
(per ref. / for Nr. / Kód: 012.995.01, 070.995.01, 081.192, 081.495.01, 083.192, 1.81.191, 1.81.386, 1.81.385*)

* ino al 05/2012 - do 05/2012 - until 05/2012

L= 300 mm.	Cr	91.81.385.03
L= 650 mm.	Cr	1.81.385.06

Prolunghe
Extensions
Prodlužka

Prolunghe
Extensions
Prodlužka

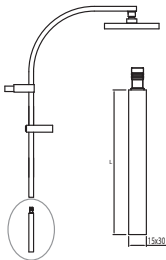

1
(per ref. / for Nr. / Kód: 1.07.395)

L= 300 mm.	Cr	91.06.914.03
L= 500 mm.	Cr	1.06.914.05

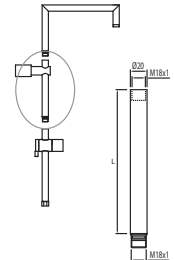

1
(per ref. / for Nr. / Kód: 90.481, 90.583, 90.281, 90.393)

L= 300 mm.	Cr	91.34.463.03
L= 650 mm.	Cr	1.34.463.02

Prolunghe
Extensions
Prodlužka

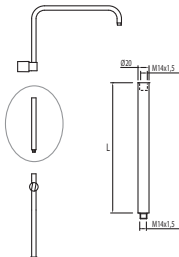

1
(per ref. / for Nr. / Kód: 90.385, 61.475, 1.81.385**)

** dal 05/2012 - od 05/2012 - since 05/2012

L= 300 mm.	Cr	91.34.195.03
L= 650 mm.	Cr	1.34.195.02



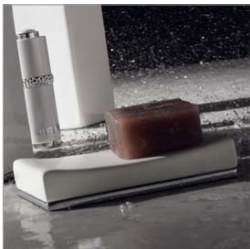

ACCESSORI ACCESORIES VYBAVENÍ



Slim-Tres



Cuadro-Tres



Max-Tres / Class-Tres



Loft-Tres



Retro-Tres

www.tresgriferia.com



RICAMBI SU
SPARE PARTS AT
NÁHRADNÍ DÍLY NA
www.tresgriferia.com



DECORAZIONE PER BAGNI PARTICOLARI DECORATION FOR SINGULAR BATHROOMS DEKORACE PRO JEDINEČNÉ KOUPELNY



Cromatura e ceramica / **Chrome plating and ceramic** / Chrom a keramika



































Gli accessori combinano la cromatura di alta resistenza con la ceramica bianca, dando semplicità e robustezza al prodotto. Gli accessori sono fabbricati con materiali di qualità resistenti all'usura. / **The accessories are supplied in a combination of high resistance chrome plating and white ceramic, making the product both simple and robust. The accessories are made of quality materials that are resistant to wear.** / Doplňky kombinují vysoce odolný chrom a bílou keramiku, produktu tak dodávají střídmy a robustní vzhled. Doplňky jsou vyrobeny z kvalitních materiálů, odolných vůči opotřebení.



Estetica minimalista / **Minimalist design** / Minimalistický vzhled

Le differenti linee di accessori hanno in comune il minimalismo estetico, offrendo adattabilità in qualsiasi spazio e facilità di pulizia. / **The different accessory lines share the same minimalist design. They are easy to clean and can be adapted to any space.** / Rozličné linie doplňků mají jako společný tento minimalistický estetický vzhled, přitom se přizpůsobí jakémukoliv prostředí a snadno se čistí.



	slim-tres	cuadro-tres	max-tres class-tres	loft-tres	retro-tres
					
					
					
					
					
					
					
	<p>Design dritto con superfici piatte e sobrie. Combinabile con accessori Cuadro-tres. / Straight design with flat, elegant surfaces. Can be combined with Cuadro-tres accessories. / Hladký design s rovnými a střídými povrchy. Kombinovatelný s doplňky Cuadro-tres.</p>	<p>Linee dritte e cubiche, si può combinare con accessori Slim-tres. / Straight, cubic lines that can be combined with Slim-tres accessories. / Rovné línie a hrany, kombinovatelné s doplňky Slim-tres.</p>	<p>Estetica tondeggiante o tubolare facilmente adattabile a qualsiasi spazio. / Rounded or tubular appearance that can easily be adapted to any space. / Kulatá a kuželovitá estetika snadno adaptabilní na jakýkoliv prostor.</p>	<p>Superfici piatte con bordi curvi, stile moderno e unico. / Flat surfaces with curved edges, modern and singular style. / Ploché povrchy s ohlazenými hranami, s moderním a jedinečným stylem.</p>	<p>L'accessorio perfetto per bagni rustici o di aspetto antico. / The perfect accessory for rustic or vintage bathrooms / Dokonalý doplněk pro koupelny v rustikálním a starodávném stylu.</p>



SLIM-TRES

Ref. / Nr. / Kód:

Portasciugamani
Towel Bar
Držák na ručníky

Portasciugamani
Towel Bar
Držák na ručníky



(450 mm.)

Cr 202.636.04



(600 mm.)

Cr 202.636.05

Portarotoli senza tappo
Paper holder without cover
Držák na toaletní papír bez krytu

Portascopino da terra in ceramica
Ceramic floor-standing toilet brush
Stojící keramický držák na WC štětka



Cr 202.636.12

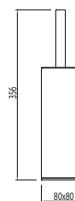

Cr 202.636.11

Spandisapone da appoggio in ceramica
Ceramic countertop soap dispenser
Stolní keramický dávkovač mýdla

Portasapone da appoggio in ceramica
Ceramic countertop soap dish
Stolní keramická mýdelnka

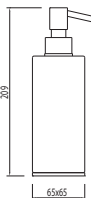

Cr 202.636.08

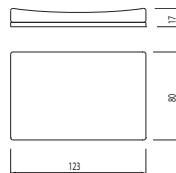

Cr 202.636.07

Bicchieri da appoggio in ceramica
Ceramic tumbler
Stolní keramický kelímek

Appendino
Fixed Holder
Háček



Cr 202.636.09

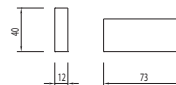

Cr 202.636.13

CUADRO-TRES

Portasciugamani
Towel Bar
Držák na ručníky

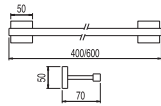

(400 mm.)
Cr **1.07.636.01**
(600 mm.)
Cr **1.07.636.03**

Pendino
Fixed Holder
Háček

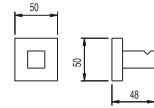

Cr **1.07.636.20**

Portasciugamani
Towel Bracket
Držák na ručníky

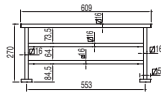

Cr **1.07.636.08**

Portascopino da terra in ceramica
Ceramic floor-standing toilet brush
Stojící keramický držák na WC štětku

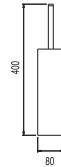

Cr **1.07.636.23**

Portarotoli senza tappo
Paper holder
Držák na toaletní papír bez krytu

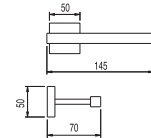

Cr **1.07.636.06**
Ac **5.07.636.06.53**

Cestino
180x180x250 mm

Bin
180x180x250 mm
Nášlapný odpadkový koš
180x180x250 mm

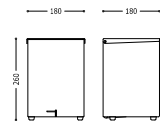

Inox **1.07.636.27**

Scopetta
Toiletbrush
WC štětka

(pro ref. č.: 187.636.23, 1.87.636.24, 1.61.636.50.23, 1.61.636.50.23, 1.61.636.60.23, 1.61.636.50.24, 1.61.636.60.24, 1.61.636.23, 1.61.636.23.53, 1.61.636.24, 5.61.636.24.53, 1.24.636.04, 5.24.636.04.51, 1.07.636.23)

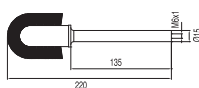

Bl **91.87.636.90**

Scopetta
(per ref.: 200.636.10, 202.636.11, 200.636.11)

Toiletbrush
(for Nr.: 200.636.10, 202.636.11, 200.636.11)

WC štětka
(pro ref. č.: 200.636.10, 202.636.11, 200.636.11)

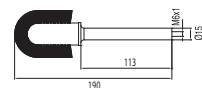

Bl **91.200.636.90**



MAX-TRES / CLASS-TRES

Ref. / Nr. / Kód:

Portasciugamani

Towel Bar

Držák na ručníky



(480 mm.)

Cr | 1.61.636.01 |

(580 mm.)

Cr | 1.61.636.02 |

Portarotoli senza tappo

Paper holder without cover

Držák na toaletní papír bez kryty

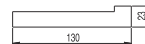

Cr | 1.14.636.09 |

Portasciugamani

Towel Bar

Držák na ručníky

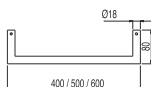

(400 mm.)

Cr | 1.14.636.01 |

(500 mm.)

Cr | 1.14.636.03 |

(600 mm.)

Cr | 1.14.636.02 |

Portascopino da terra in ceramica

Ceramic floor-standing toilet brush

Stojící keramický držák na WC štětku

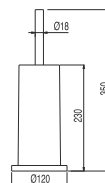

Cr | 1.61.636.23 |

Portasciugamani asta doppia

Double towel bar

Držák na ručníky

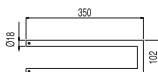

Cr | 1.14.636.10 |

Portascopino da parete in ceramica

Ceramic wall-mounted toilet brush

Nástěnný keramický držák na WC štětku

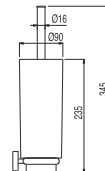

Cr | 1.61.636.24 |

Portarotoli senza tappo

Paper holder without cover

Držák na toaletní papír bez kryty

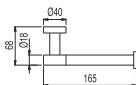

Cr | 1.61.636.06 |

Portascopino da parete

Wall-mounted toilet brush

Nástěnný držák na WC štětku



Cr | 1.34.636.24 |

Spandisapone da parete in ceramica
Ceramic wall-mounted soap dispenser
Nástěnný keramický dávkovač mýdla

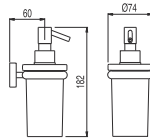

Cr 1.61.636.18

Portaspazzolini da parete in ceramica
Ceramic wall-mounted toothbrush holder
Nástěnný keramický držák na kartáč

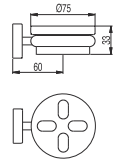

Cr 1.61.636.16
Ac 5.61.636.16.53

Maniglia vasca
Bath tub holder
Vanová rukojeť

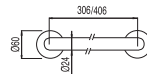

(306 mm.)
Cr 1.34.184
(406 mm.)
Cr 1.34.184.40

Pendino
Fixed Holder
Háček

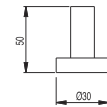

Cr 1.61.636.20

Maniglia con portasapone
Bath tub holder with soapdish
Rukojeť s mýdlenkou

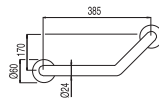

Cr 1.34.183



LOFT-TRES

Ref. / Nr. / Kód:

Portasciugamani
Towel Bar
Držák na ručníky

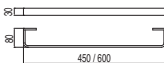

(450 mm.)

Cr | 200.636.04 |

(600 mm.)

Cr | 200.636.05 |

Mensola cristallo trasparente
Wall bracket
Průsvitná skleněná policička

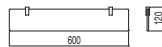

(600 mm.)

Cr | 200.636.06 |

Portarotoli senza tappo
Paper holder
Držák na toaletní papír bez kryty

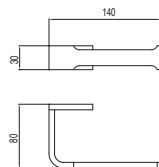

Cr | 200.636.12 |

Mensola cristallo trasparente
Wall bracket
Průsvitná skleněná policička

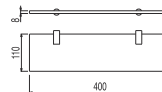

(400 mm.)

Cr | 1.61.636.15 |

Portascopino da terra in ceramica
Ceramic floor-standing toilet brush
Stojící keramický držák na WC štětku

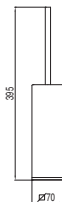

Cr | 200.636.11 |

Spandisapone da appoggio in ceramica
Ceramic countertop soap dispenser
Stolní keramický dávkovač mýdla

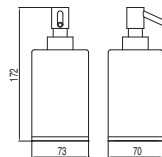

Cr | 200.636.08 |

Portascopino da parete in ceramica
Ceramic wall-mounted toilet brush
Nástěnný keramický držák na WC štětku

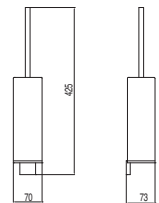

Cr | 200.636.10 |

Portasapone da appoggio in ceramica
Ceramic countertop soap dish
Stolní keramická mýdlenka

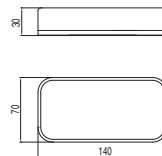

Cr | 200.636.07 |

Bicchieri da appoggio in ceramica
Ceramic tumbler
 Stolní keramický kelímek

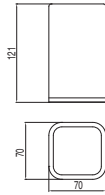

Cr | **200.636.09** |

Appendino
Fixed Holder
 Háček

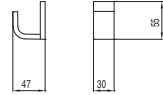

Cr | **200.636.13** |



RETRO-TRES

Ref. / Nr. / Kód:

Portasciugamani

Towel Bar

Držák na ručníky



	(400 mm.)
Cr	1.24.636.01
Lv	5.24.636.01.51
	(600 mm.)
Cr	1.24.636.03
Lv	5.24.636.03.51

Portarotoli con tappo

Paper holder with cover

Držák na toaletní papír s krytem

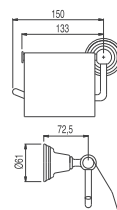

Cr	1.24.636.05
Lv	5.24.636.05.51

Portasciugamani asta doppia

Double towel bar

Držák na ručníky, s dvojitou tyčí

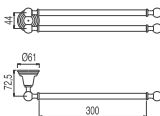

Cr	1.24.636.08
Lv	5.24.636.08.51

Portasciugamani ad anello aperta a sinistra con portasapone

Combo open ring Holder with soapdish

Držák na ručník zleva otevřený s mýdlenkou

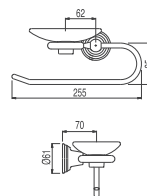

Cr	1.24.636.11
Lv	5.24.636.11.51

Portasciugamani ad anello quadrato

Square Towel Holder

Čtverhranný držák na ručník

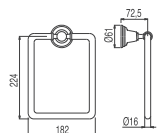

Cr	1.24.636.09
Lv	5.24.636.09.51

Mensola cristallo trasparente

Wall bracket

Průsvitná skleněná polička

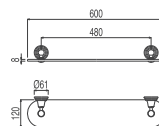

Cr	1.24.636.15
Lv	5.24.636.15.51

Portarotoli senza tappo

Paper holder without cover

Držák na toaletní papír bez krytu

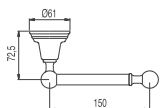

Cr	1.24.636.06
Lv	5.24.636.06.51

Portabicchiere da parete in ceramica

Ceramic wall-mounted tumbler holder

Nástěnný keramický držák na kelímek

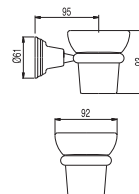

Cr	1.24.636.12
Lv	5.24.636.12.51

Portabicchiere-Portasapone da appoggio in ceramica
Ceramic countertop tumbler holder-soap dish
Stolní keramický držák na kelímek a mýdlo

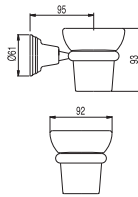

Cr	1.24.636.13
Lv	5.24.636.13.51

Portascopino da terra in ceramica
Ceramic floor-standing toilet brush
Stojící keramický držák na WC štětku

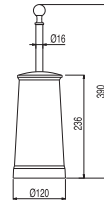

Cr	1.24.636.04
Lv	5.24.636.04.51

Portasapone da parete in ceramica
Ceramic wall-mounted soap dish
Nástěnná keramická mýdelna

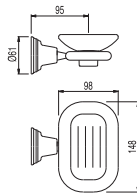

Cr	1.24.636.10
Lv	5.24.636.10.51

Appendino
Fixed Holder
Háček

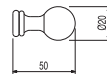

Cr	1.24.636.07
Lv	5.24.636.07.51





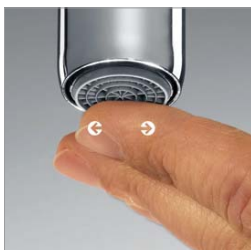

COMPLEMENTI ACCESSORIES PŘÍSLUŠENSTVÍ



Valvola
Valve
Ventil
354



Scarico vasca
Bath drain
Vanový sifon
360



Sifone
Siphon
Sifon
362



Rosone
Cover plate
Krycí rozeta
365



Erogatore Vasca
Spout
Výtoková hubice
365



Chiave di regolazione
Adjustment key
Uzavírací ventil
368



Altri
Other
Ostatní
369



Limitatori di flusso
Flow restrictors
Omezovače průtoku
373



Ariatore
Aerator
Perlátor
374



RICAMBI SU
SPARE PARTS AT
NÁHRADNÍ DÍLY NA
www.tresgriferia.com

www.tresgriferia.com



Valvola SIMPLE-RAPID

Bloccaggio superiore

Ventil SIMPLE-RAPID

Horní blokáda

SIMPLE-RAPID valve

Upper locking system

Min. 0 mm
Máx. 60 mm

Ref./Nr./Kód.:

1.61.840

5.61.840.01

5.61.840.03

Piano senza troppopieno
Counter top without overflow drain
Deska bez přeřadu

Min. 17 mm
Máx. 60 mm

Ref./Nr./Kód.:

1.62.840

Piano con troppopieno
Counter top with overflow drain
Deska s přeřadem

Valvola lavabo

Bloccaggio inferiore

Ventil pro umyvadlo

Spodní blokáda

Valve for basin

Inferior locking system

Min. 27 mm
Máx. 85 mm

Ref./Nr./Kód.:

1.34.940.10

1.34.941.10

1.34.942.10

Piano in legno, ecc.
Wood counter top, etc.
Dřevěná deska a jiné.

VALVOLA SIMPLE-RAPID / VENTIL SIMPLE-RAPID / SIMPLE-RAPID VALVE

Ref./Nr./Kód: Price

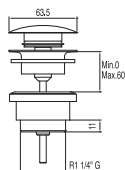

Valvola SIMPLE-RAPID
Ø 63,5 mm CLICK-CLACK
SIMPLE-RAPID valve
Ø 63,5 mm CLICK-CLACK
Ventil SIMPLE-RAPID
zátka Ø 63,5 mm CLICK-CLACK

Cr	1.61.840	39,05
Lv	5.61.840.01	74,90
Ac	5.61.840.03	74,90

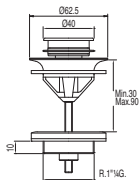

Valvola SIMPLE-RAPID
CLICK-CLACK
SIMPLE-RAPID valve
CLICK-CLACK
Ventil SIMPLE-RAPID
CLICK-CLACK

Cr	1.62.840	31,05
----	----------	-------

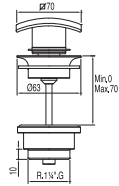

Valvola SIMPLE-RAPID CUADRO-TRES
70x70 mm CLICK-CLACK

SIMPLE-RAPID valve CUADRO-TRES
70x70 mm CLICK-CLACK

Ventil SIMPLE-RAPID pro řadu CUADRO-TRES
Čtverhranná zátka 70x70 mm CLICK-CLACK

Cr	1.07.940	68,10
----	----------	-------

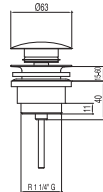

Valvola SIMPLE-RAPID
Ø 63 mm CLICK-CLACK

SIMPLE-RAPID valve
Ø 63 mm CLICK-CLACK

Umyvadlový ventil SIMPLE-RAPID
zátka Ø 63 mm CLICK-CLACK

Cr	1.34.540.10	23,35
----	-------------	-------

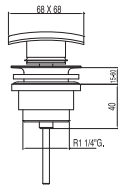

Valvola SIMPLE-RAPID
68x68 mm CLICK-CLACK

SIMPLE-RAPID valve
68x68 mm CLICK-CLACK

Umyvadlový ventil SIMPLE-RAPID
Čtvercová zátka 68x68 mm CLICK-CLACK

Cr	1.34.340.10	26,95
----	-------------	-------

VALVOLA LAVABO SENZA TROPPOPIENO / VALVE FOR BASIN WITHOUT OVERFLOW DRAIN / VENTIL PRO UMYVADLO BEZ PŘEPADU

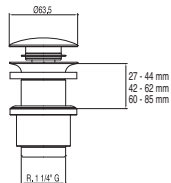

Valvola lavabo
Ø 63,5 mm CLICK-CLACK

Valve for basin
Ø 63,5 mm CLICK-CLACK

Zaslepený ventil pro dřevěné umyvadlo
zátka Ø 63,5 mm CLICK-CLACK

	(27 - 44 mm.)	
Cr	1.34.940.10	55,00

	(42 - 62 mm.)	
Cr	1.34.941.10	56,90

	(60 - 85 mm.)	
Cr	1.34.942.10	60,45

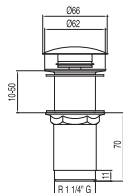

Valvola lavabo senza troppopieno
Ø 66 mm CLICK-CLACK

Valve for basin without overflow drain
Ø 66 mm CLICK-CLACK

Umyvadlový ventil bez přepadu
zátka Ø 66 mm CLICK-CLACK

Cr	1.34.540.60	22,00
----	-------------	-------



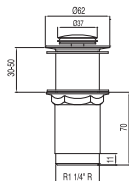

Valvola lavabo senza troppopieno
Ø 37 mm CLICK-CLACK

Valve for basin without overflow drain
Ø 37 mm CLICK-CLACK

Umyvadlový ventil bez přepadu
zátka Ø 37 mm CLICK-CLACK

Cr 1.34.540.50 | 19,25

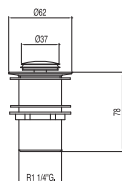

Valvola lavabo senza troppopieno
Ø 37 mm CLICK-CLACK

Valve for basin without overflow drain
Ø 37 mm CLICK-CLACK

Umyvadlový ventil bez přepadu
zátka Ø 37 mm CLICK-CLACK

Cr 1.34.540.70 | 16,35

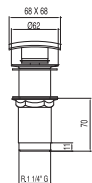

Valvola lavabo senza troppopieno
68x68 mm CLICK-CLACK

Valve for basin without overflow drain
68x68 mm CLICK-CLACK

Umyvadlový ventil bez přepadu
Čtvercová zátka 68x68 mm CLICK-CLACK

Cr 1.34.341.20 | 26,95

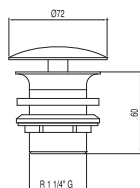

Valvola lavabo a scarico libero (scarico sempre aperto)
Ø 72 mm

Free basin valve (drain always open)
Ø 72 mm

Umyvadlový ventil s volným (vždy otevřeným) odtokem
zátka Ø 72 mm

Cr 1.34.240.10 | 20,25

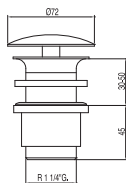

Valvola lavabo a scarico libero (scarico sempre aperto)
Ø 72 mm

Free basin valve (drain always open)
Ø 72 mm

Umyvadlový ventil s volným (vždy otevřeným) odtokem
zátka Ø 72 mm

Cr 1.34.240.20 | 25,70

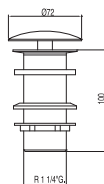

Valvola lavabo a scarico libero (scarico sempre aperto)
Ø 72 mm

Free basin valve (drain always open)
Ø 72 mm

Umyvadlový ventil s volným (vždy otevřeným) odtokem
zátka Ø 72 mm

Cr 1.34.240.30 | 21,65

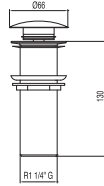

Valvola lavabo senza troppopieno
Ø 66 mm CLICK-CLACK

Valve for basin without overflow drain
Ø 66 mm CLICK-CLACK

Umyvadlový ventil bez přepadu
zátka Ø 66 mm CLICK-CLACK

Cr | 1.34.540.30 | 33,75

VALVOLA LAVABO CON TROPPOPIENO / VALVE FOR BASIN WITH OVERFLOW DRAIN / VENTIL PRO UMYVADLO S PŘEPADEM

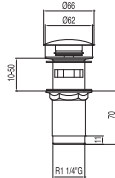

Valvola lavabo con troppopieno
Ø 66 mm CLICK-CLACK

Valve for basin with overflow drain
Ø 66 mm CLICK-CLACK

Umyvadlový ventil s přepadem
zátka Ø 66 mm CLICK-CLACK

Cr | 1.34.541.60 | 22,00

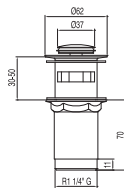

Valvola lavabo con troppopieno
Ø 37 mm CLICK-CLACK

Valve for basin with overflow drain
Ø 37 mm CLICK-CLACK

Umyvadlový ventil s přepadem
zátka Ø 37 mm CLICK-CLACK

Cr | 1.34.541.10 | 19,25

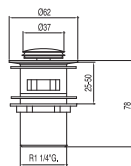

Valvola lavabo con troppopieno
Ø 37 mm CLICK-CLACK

Valve for basin with overflow drain
Ø 37 mm CLICK-CLACK

Umyvadlový ventil s přepadem
zátka Ø 37 mm CLICK-CLACK

Cr | 1.34.541.90 | 16,35

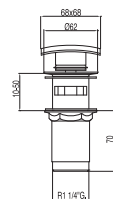

Valvola lavabo con troppopieno
68x68 mm CLICK-CLACK

Valve for basin with overflow drain
68x68 mm CLICK-CLACK

Umyvadlový ventil s přepadem
Čtvercová zátka 68x68 mm CLICK-CLACK

Cr | 1.34.340.20 | 26,95



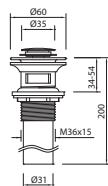

Valvola lavabo con troppopieno

Ø 35 mm CLICK-CLACK

Valve for basin with overflow drain

Ø 35 mm CLICK-CLACK

Umyvadlový ventil s přeřadem

zátka Ø 35 mm CLICK-CLACK

Cr 034.540.02 | 23,25

VALVOLA LAVABO / VALVE FOR BASIN / VENTIL PRO UMYVADLO

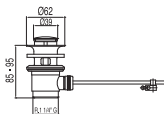

Scarico automatico

Automatic drain

Ventil automatického odtoku

Cr 1.34.743.10 | 15,35



Valvola lavabo con troppopieno

Tappo in ottone con catenella

Valve for basin with overflow drain

Brass plug with chain

Umyvadlový ventil s přeřadem

Mosazná zátká s řetízkiem

Cr 1.34.743.20 | 15,35



Valvola lavabo senza troppopieno

Tappo in ottone con catenella

Valve for basin without overflow drain

Brass plug with chain

Umyvadlový ventil bez přeřadu

Mosazná zátká s řetízkiem

Cr 1.34.743.30 | 15,35

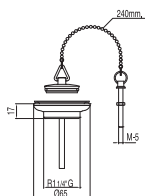

Valvola lavabo senza troppopieno

Tappo in ottone con catenella

Valve for basin without overflow drain

Brass plug with chain

Odtokový ventil umyvadla bez přeřadu

Mosazná zátká s řetízkiem

Cr 1.34.639.10 | 9,00

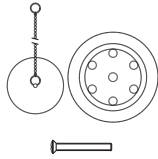

Set accessori per lavabo, bidé e lavello Ø 70
catena da 42 cm.

Bidet and sink accessories Ø 70
Chain of 42 cm.

Souprava příslušenství pro umyvadlovou, bidetovou a
dřezovou baterii Ø 70
mosazná zátka s řetízkiem 420 mm

Lv | 91.34.746.0.5.1 | 33,90

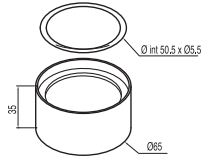

Supplemento valvola
Ø 65 x 35 mm.

Height supplement
Ø 65 x 35 mm.

Kroužek pro umyvadlové ventily
Ø 65 x 35 mm.

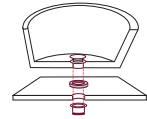

Cr | 91.61.103.48 | 32,15

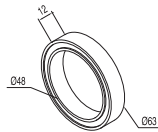

Supplemento valvola
Ø 63 x 12 mm.

Height supplement
Ø 63 x 12 mm.

Kroužek pro umyvadlové ventily
Ø 63 x 12 mm.

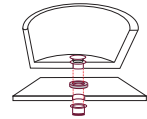

Cr | 1.34.633.10 | 12,50

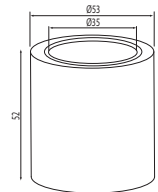

Set bloccaggio occulto
per top trasparenti

To hide locking set
for transparent countertops

Celek pro skrytí-blokování
pro průhledné desky

Cr | 91.61.103.14 | 20,00

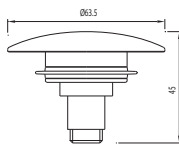

Tappo CLICK-CLACK
Ø 63,5 mm (per ref: 1.61.840)

Cap CLICK-CLACK
Ø 63,5 mm (for Nr.: 1.61.840)

Zátka CLICK-CLACK
Ø 63,5 mm (pro ref. č.: 1.61.840)

Cr | 91.61.840.60 | 25,15

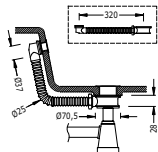

Boccola per scarichi a vista con troppopieno

Cap for visible drains with counter top

Výpust' pro viditelné odtoky s přepladem



Cr | 1.34.634.50 | 21,50



SCARICO VASCA / BATH DRAIN / VANOVÝ SIFON

Ref. / Nr. / Kód: Price

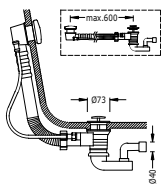

Scarico vasca con troppo pieno e valvola automatica
Ø 73 mm

Bath drain with overflow and pop-up waste
Ø 73 mm

Automatický odtok vany s přeřadem
zátka Ø 73 mm



Cr	1.34.846	97,90
Lv	5.34.846.01	195,00

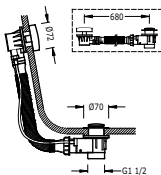

Scarico vasca con troppo pieno e valvola automatica
Ø 43 mm

Bath drain with overflow and pop-up waste
Ø 43 mm

Automatický odtok vany s přeřadem
zátka Ø 43 mm



Cr	1.34.534.10	31,05
----	-------------	-------

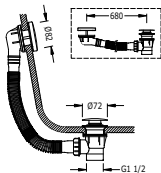

Scarico vasca con troppo pieno e valvola
Ø 72 mm CLICK-CLACK

Bath drain with overflow and pop-up waste
Ø 72 mm CLICK-CLACK

Vanový sifon s lankem pro řízení odtoku, ozdobné metalové
viditelné prvky
Ø 72 mm CLICK-CLACK

Cr	1.34.534.20	24,20
----	-------------	-------

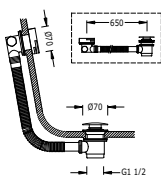

Scarico vasca e valvola di riempimento rotonda A CASCATA
con troppopieno
Ø 70 mm CLICK-CLACK

Bath drain and round CASCADE filling valve with overflow
drain
Ø 70 mm CLICK-CLACK

Odtoková a napouštěcí vanová kulatá souprava KASKÁDA s
přeřadem
zátka Ø 70 mm CLICK-CLACK



Cr	1.34.534.30	55,35
----	-------------	-------

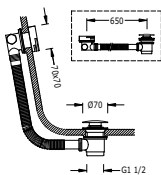

Scarico vasca e valvola di riempimento quadrata A CASCATA
con troppopieno
Ø 70 mm CLICK-CLACK

Bath drain and square CASCADE filling valve with overflow
drain
Ø 70 mm CLICK-CLACK

Odtoková a napouštěcí vanová hranatá souprava KASKÁDA
s přeřadem
zátka Ø 70 mm CLICK-CLACK



Cr	1.34.534.40	73,90
----	-------------	-------

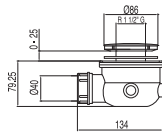

Scarico ispezionabile
Ø 86 mm. Scolo 15 l/min.

Siphon drain for inspection
Ø 86 mm. Drain 15 l/min

Rozšroubovatelný sifonový odtok pro sprchovou vaničku, se zabudovaným sifonem
odtok 15 l/min, Ø 86 mm

Cr | 1.34.552 | 28,90

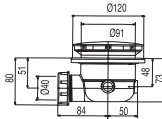

Scarico ispezionabile
Ø 120 mm. Scolo 31 l/min.

Siphon drain for inspection
Ø 120 mm. Drain 31 l/min

Rozšroubovatelný sifonový odtok pro sprchovou vaničku, se zabudovaným sifonem
odtok 31 l/min, Ø 120 mm

Cr | 1.04.840 | 42,65

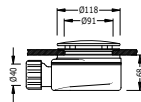

Scarico ispezionabile
Ø 118 mm. Scolo 62 l/min.

Siphon drain for inspection
Ø 118 mm. Drain 62 l/min

Rozšroubovatelný sifonový odtok pro sprchovou vaničku, se zabudovaným sifonem
odtok 62 l/min, Ø 118 mm

Cr | 1.04.841 | 42,65

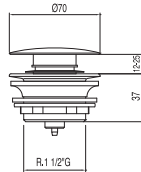

Valvola
Ø 70 mm CLICK-CLACK

Valve
Ø 70 mm CLICK-CLACK

Vanový ventil
zátka Ø 70 mm CLICK-CLACK

Cr | 1.34.740.10 | 18,65

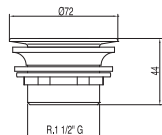

Valvola
Ø 72 mm

Valve
Ø 72 mm

Odtok pro prádelnové umyvadlo nebo podobné
Ø 72 mm

Cr | 1.34.740.20 | 8,05

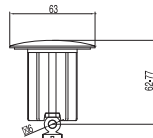

Tappo con supplemento estetico per scarico automatico
Ø 63 1,1/4"

Plug with trim supplement for automatic drain
Ø 63 mm 1,1/4"

Zátka se zkrášlujícím doplňkem pro automatický odtok
Ø 63 mm standardní automatický odtok

Cr | 91.34.840.26 | 10,75



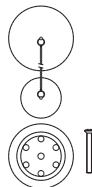

Set accessori per vasca Ø 70
catena da 42 cm.

Accessories for bath Ø 70
Chain of 42 cm.

Souprava příslušenství pro vanovou baterii Ø 70
řetěz 420 mm

Lv 91.34.745.0.5.1 41,95

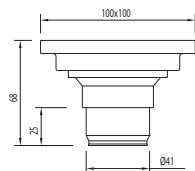

Scarico
Ottone
Drain trap
Brass
Odtokový kanálek
Mosaz

Cr 034.740.07 20,55

SIFONE / SIPHON / SIFON

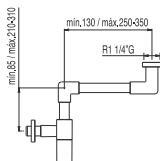

Sifone telescopico a vista per lavabo
Telescopic visible basin drain trap
Umyvadlový viditelný sifon, ohnutý, výsuvný

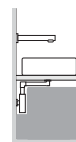

Cr 1.61.103.62 160,00

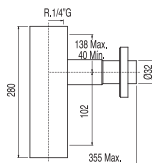

Sifone telescopico a vista per lavabo CON PANNELLO
Telescopic visible basin drain trap WITH SKIRT
Umyvadlový viditelný sifon, čtverhranný, výsuvný, s krytem

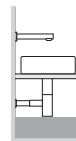

Cr 1.07.103.42 187,00

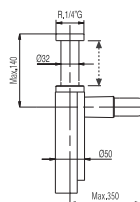

Sifone telescopico a vista per lavabo CON PANNELLO
Telescopic visible basin drain trap WITH SKIRT
Výsuvný umyvadlový viditelný sifon s krytem

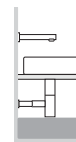

Cr 1.61.103.42 160,00
Lv 5.61.103.4.5.1 219,00

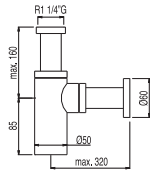

Sifone telescopico a vista per lavabo
Telescopic visible basin drain trap
Výsuvný umyvadlový viditeľný sifon

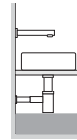

Cr | 1.61.103.72 | 74,90

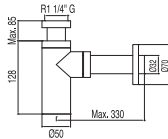

Sifone telescopico a vista per lavabo
Telescopic visible basin drain trap
Výsuvný umyvadlový viditeľný sifon

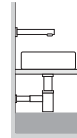

Cr | 1.34.634.10 | 38,05

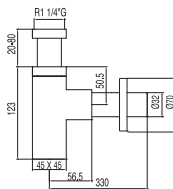

Sifone telescopico a vista per lavabo
Telescopic visible basin drain trap
Čtverhranný, výsuvný umyvadlový sifon viditeľný

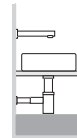

Cr | 1.34.634.20 | 55,45

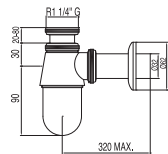

Sifone a bottiglia facilmente ispezionabile per lavabo
Self-inspecting bottle-type drain trap for basin
Umyvadlový lahvový sifon, rozšroubovateľný

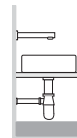

Cr | 1.34.634.30 | 23,60

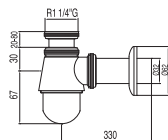

Sifone a bottiglia facilmente ispezionabile per bidet
Self-inspecting bottle-type drain trap for bidet
Bidetový lahvový sifon, rozšroubovateľný

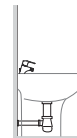

Cr | 1.34.634.40 | 23,60

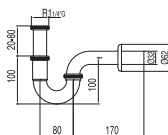

Sifone curvo articolato per lavabo
Curved, articulated drain trap for basin
Umyvadlový sifon s klbovým zakřivením

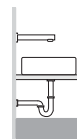

Cr | 1.34.638.10 | 20,25



ROSONE / COVER PLATE / KRYCÍ ROZETA

Ref./Nr./Kód: Price

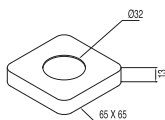

Rosone
65x65, Ø32, 13 mm

Cover plate
65x65, Ø32, 13 mm

Čtvercová kovová rozeta
vnější rozměry 65x65, vnitřní rozměry Ø 32, výška 13 mm

Cr | 91.34.744.10 | 5,20

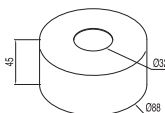

Rosone
Ø 88, Ø 32, 45 mm

Cover plate
Ø 88, Ø 32, 45 mm

Kulatá kovová rozeta
vnější rozměry Ø 88, vnitřní rozměry Ø 32, výška 45 mm

Cr | 91.34.744.30 | 7,70

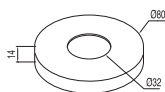

Rosone
Ø 80, Ø 32, 14 mm

Cover plate
Ø 80, Ø 32, 14 mm

Kulatá kovová rozeta
vnější rozměry Ø 80, vnitřní rozměry Ø 32, výška 14 mm

Cr | 91.34.744.20 | 5,20

EROGATORE VASCA / SPOUT / VÝTOKOVÁ HUBICE

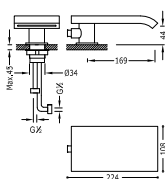

Erogatore a cascata
Cascade cast spout
Ramínko s vodopádem

Cr | 1.62.161.50 | 387,00

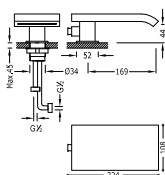

Erogatore a cascata
Cascade cast spout
Ramínko s vodopádem

Cr | 1.87.182.50 | 409,00



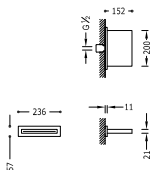

Bocca a cascata set doccia
Cascade cast spout bath mixer
 Ramínko s vodopádem k baterii pro vanu-sprchu nebo umyvadlo

Cr 299.903.04 367,00

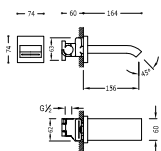

Erogatore a cascata
Cascade cast spout
 Ramínko s vodopádem

Cr 1.07.181 248,00

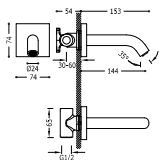

Canna parete
Wall spout
 Nástěnné ramínko

Cr 210.181.07 101,00

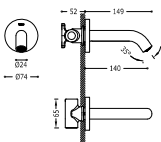

Canna parete
Wall spout
 Nástěnné ramínko

Cr 262.180.04 101,00

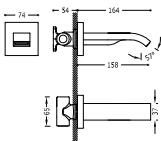

Erogatore a cascata
Cascade cast spout
 Ramínko s vodopádem

Cr 207.181.07 248,00

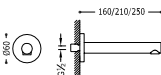

Canna parete
Wall spout
 Nástěnné ramínko

 (160 mm.)
 Cr 1.61.170.02 91,35

 (210 mm.)
 Cr 061.172.02 104,00

 (250 mm.)
 Cr 1.61.171.02 116,00

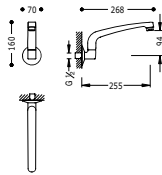

Tubo fuso girevole
distanza da parete di 20,4 cm.

Swivel cast spout
distance from wall 20,4 cm.

Otočné lité ramínko
204 mm (nástěnné)

Cr	1.34.301	83,20
----	----------	-------

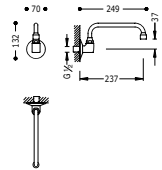

Gruppo girevole

Tube spout

Otočné trubkové ramínko

	(240 mm.)	
Cr	1.34.302	44,55

	(290 mm.)	
Cr	1.34.303	47,50

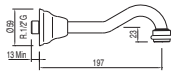

Canna parete RETRO-TRES

Wall spout RETRO-TRES

Nástěnné ramínko RETRO-TRES

Cr	1.24.173	86,10
Lv	5.24.173.01	115,00



RUBINETTI DI ARRESTO / SHUTOFF VALVES / PRŮCHOZÍ VENTILY

Ref. / Nr. / Kód: Price

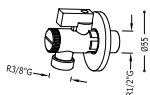

Chiave di regolazione con filtro
R.1/2" - R.3/8"

Gate-valve with filter
R.1/2" - R.3/8"

Uzavírací ventil s filtrem
R.1/2" - R.3/8"



Cr 91.34.525 15,10

N

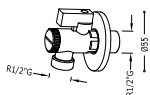

Chiave di regolazione con filtro
R.1/2" - R.1/2"

Gate-valve with filter
R.1/2" - R.1/2"

Uzavírací ventil s filtrem
R.1/2" - R.1/2"



Cr 299.525.05 15,10

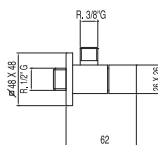

Chiave di regolazione
Adjustment key
Čtverhranný regulační ventil

Cr 1.34.742.20 14,05

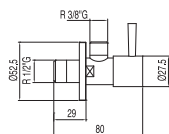

Chiave di regolazione
Adjustment key
Regulační ventil

Cr 1.34.742.10 11,55

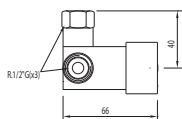

Miscelatore due acque CON TUBI FLESSIBILI
(TRESTRONIC, TOUCH-TRES, TEMPO-TRES)

Two-water mixer WITH FLEXIBLE PIPES
(TRESTRONIC, TOUCH-TRES, TEMPO-TRES)

Směšovač na dvě vody S FLEXIBILNÍMI TRUBKAMI
pro umyvadlové baterie TRESTRONIC, TOUCH-TRES a
TEMPO-TRES

Cr 1.92.507.30 64,60

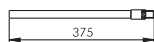

Tubo rigido
Copper connections
Spoj pevné trubky

M.10x100 (370 mm.)
Cr 91.34.800.2 6,65

M.9x100 (320 mm.)
Cr 91.34.800.1 6,65

M.8x100 (350 mm.)
Cr 91.34.800.50 6,65

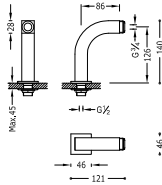

Gomito adattatore bagno-doccia
2 unità con silenziatore

Shower-bath elbow adaptor
2 units with silencer

Rohový ventil vana-sprcha
2 kusy s tlumičem

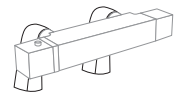

Cr | 299.870.02 | 113,00

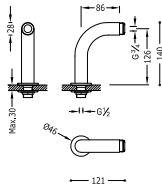

Gomito adattatore bagno-doccia
2 unità con silenziatore

Shower-bath elbow adaptor
2 units with silencer

Rohový ventil vana-sprcha
2 kusy s tlumičem

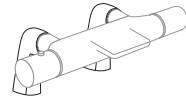

Cr | 299.870.01 | 101,00

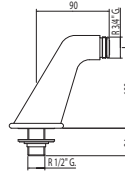

Gomito adattatore bagno-doccia
2 unità con silenziatore

Shower-bath elbow adaptor
2 units with silencer

Rohový ventil vana-sprcha
2 kusy s tlumičem

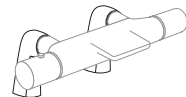

Cr | 024.871.01 | 123,00

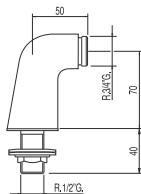

Gomito adattatore bagno-doccia
2 unità con silenziatore

Shower-bath elbow adaptor
2 units with silencer

Rohový ventil vana-sprcha
2 kusy s tlumičem

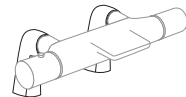

Cr | 1.34.870 | 79,15

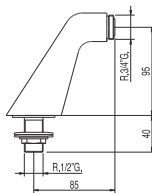

Gomito adattatore bagno-doccia
2 unità con silenziatore

Shower-bath elbow adaptor
2 units with silencer

Rohový ventil vana-sprcha
2 kusy s tlumičem

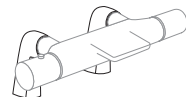

Cr | 1.34.871 | 91,35

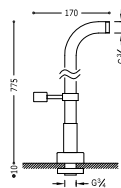

Prese d'acqua a terra per vasca da bagno
2 unità con supporto doccia girevole

Water intake at floor of bath
2 units with adjustable shower support

Vodovodní přípojky na okraj vany
2 kusy s otočným sprchovým držákem

Cr | 1.61.194 | 275,00





Rubinettoni arresto
Threaded-ends gate-valve
Ventil

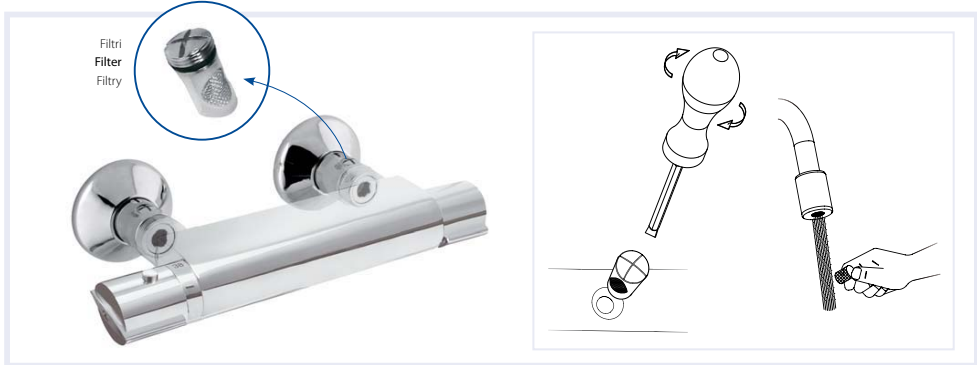

Eccentrico con filtro
speciale per gruppi termostatici

**Excentric union with filter
special for thermostatic taps**

Sada 2 excentrů s filtrem a rozetou
speciálně určeno pro termost. baterie

Cr | 1.94.170.19 | 53,30

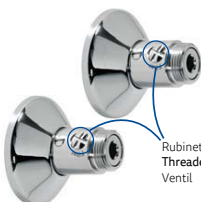

Rubinettoni arresto
Threaded-ends gate-valve
Ventil

Eccentrico con filtro
speciale per gruppi termostatici+Rubinettoni arresto

**Excentric union with filter
special for thermostatic taps+T hreaded-ends gate-valve**

Sada 2 excentrů s filtrem a rozetou
speciálně určeno pro termost. baterie + uzavírací ventily

Cr | 1.94.170.29 | 65,95



VALVOLA / VALVE / VENTIL

Ref. / Nr. / Kód: Price

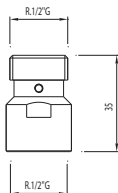

Valvola di svuotamento
Outlet valve
Vypouštěcí ventil



Cr 91.34.789.06 15,35

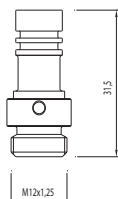

Valvola di svuotamento CUADRO
(per ref.: 07.395, 07.926, 07.131)
Outlet valve CUADRO
(for Nr.: 07.395, 07.926, 07.131)
Vypouštěcí ventil CUADRO
(Kód.: 07.395, 07.926, 07.131)



Cr 91.34.789.07 13,00

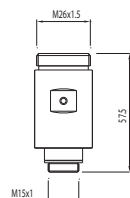

Valvola di svuotamento LEX, MAX
Dal 2012 (per ref.: 81.385, 81.191)
Outlet valve LEX, MAX
since 2012 (for Nr.: 81.385, 81.191)
Vypouštěcí ventil LEX, MAX
od 2012 (Kód.: 81.385, 81.191)



Cr 91.34.789.08 15,35

LIMITATORE ANTILEGIONELLA E ANTIGOCCIA ANTI-LEGIONELLA AND NO-DRIP WATER INLET RESTRICTOR OMEZOVAČ-VYPRAZDŇOVAČ PROTI BAKTERII LEGIONELLA A PROTI KAPÁNÍ



- Limita il flusso d'acqua eliminando la pressione nel soffione.
- Evita la procreazione di batteri come la legionella.
- Una volta terminato l'uso della doccia, evita il gocciolamento del soffione.

- Limits the flow of water, meaning there is no pressure in the shower head.
- Avoids the growth of bacteria such as legionella.
- Prevents dripping from the shower head when the shower is no longer in use.

- Omezuje průtok vody a uvolňuje tlak v kropítku.
- Zabraňuje rozmnožování bakterií jako legionela.
- Když se sprcha nepoužívá, zabraňuje kapání kropítka.

Funziona con le docce / For use with showers / Vhodné pro sprchy: 1.34.126, 91.34.729, 91.34.729.06, 91.34.725, 1.34.821, 1.34.617, 1.34.616, 1.34.924, 91.34.824, 91.34.825.10, 1.34.611.
Funziona con i soffioni* / For use with spray nozzles* / Vhodné pro kropítka*: 1.34.138.25, 1.34.138.26, 1.34.138.30, 1.93.123.10, 1.34.137.25, 1.34.137.26, 1.34.137.30.

*Miglior funzionamento se si elimina il limitatore dai soffioni. / *Works better if the restrictor is removed from the spray nozzles. / *Pokud omezovač kropítek sejmete, funguje lépe.

LIMITATORI DI FLUSSO / FLOW RESTRICTORS / OMEZOVAČE PRŮTOKU

Ref./Nr./Kód: Price

Limitatore di portata
Maschio 24/100.

Flow reducer
Male 24/100.

Omezovač průtoku
vnější závit 24/100.

Limitatore di portata
femmina 22/100.

Flow reducer
female 22/100.

Omezovač průtoku
vnitřní závit 22/100.



		(6 l/m.)
Cr	91.34.682.6	2,80
	certificato/certificate/osvědčení (8 l/m.)	
Cr	91.34.682	9,55
	certificato/certificate/osvědčení (5 l/m.)	
Cr	91.34.682.5	9,55



		(6 l/m.)
Cr	91.34.681.6	2,55
	certificato/certificate/osvědčení (8 l/m.)	
Cr	91.34.681	9,55
	certificato/certificate/osvědčení (5 l/m.)	
Cr	91.34.681.5	9,55



Limitatore di portata
1/2" - 1/2" maschio - femmina.

Flow reducer
1/2" - 1/2" male - female.

Omezovač průtoku
1/2" - 1/2" Vnější-vnitřní závit.



		(8 l/m.)
Cr	91.34.683.8	2,35
	certificato/certificate/osvědčení (8 l/m.)	
Cr	91.34.683	5,95

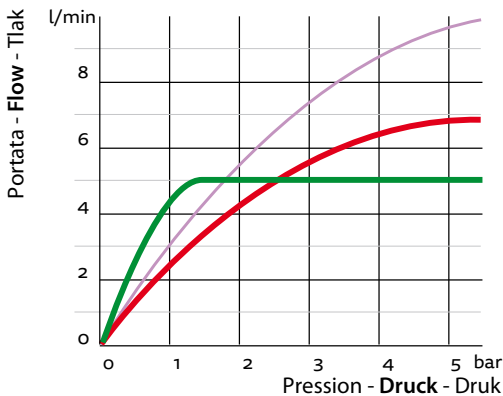

✓ Limitatori = portata COSTANTE = **TRES**
 Restrictors = CONSTANT flow = **TRES**
 Omezovače = NEMĚNNÝ průtok = **TRES**

✗ Riduttori = portata VARIABILE = ALTRI
 Reducers = VARIABLE flow = OTHERS
 Redukční ventily = PROMĚNNÝ průtok = JINÉ ZNAČKY

● Rompigetto convenzionali
 Conventional aerators
 Konvenční perlátory



ARIATORE / AERATOR / PERLÁTOR

Ref. / Nr. / Kód: Price

Ariatore maschio SLC
24/100 per lavabo, bidé e lavello.

Aerator SLC
24/100 for wash-basin, bidet and sink mixers.

Perlátor s vnějším závitem Cascade SLC
Pro umyvadlovou, bidetovou a dřezovou baterii (pro celky vana-sprcha a ref. č. 14.100, 14.160, 62.100, 63.151) 24/100



Cr	91.34.673	5,30
Ac	91.34.673.5.0.3	9,80
Lv	91.34.673.5.0.1	9,80

Ariatore femmina SLC
22/100

Aerator SLC
22/100

Perlátor s vnějším závitem Cascade SLC
(pro ref. č. 23.120, 23.525, 70.120, 72.120, 73.120, 34.880) 22/100



Cr	91.34.672	5,10
Lv	91.34.672.5.0.1	9,80

Ariatore maschio
24/100 per bagno e doccia

Aerator
24/100 for bath and shower

Perlátor s vnějším závitem
24/100 vanových, sprchových,



Cr	299.663.10	5,30
----	------------	------

Ariatore maschio 24/100

Aerator male 24/100

Perlátor vnější 24/100



	299.610.01	4,00
--	------------	------

Ariatore maschio 16/100

Aerator male 16/100

Perlátor vnější 26/100



	299.610.02	5,20
--	------------	------

Rompigetto orientabile + rubinetto maschio 24/100

Swivel aerator + key male 24/100

Nastavitelný sytič vzduchem + klíč vnější 24/100



	299.610.06	5,40
--	------------	------

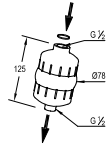

Filtro ANTICLORO

Acqua filtrata fino a 10.000 litri.

ANTI-CHLORINE filter

Filtering water up to 10.000 litres.

Filtr NA CHLOR pro SPRCHU

Až 10 tisíc litrů filtrované vody.

1.30.355.90

67,65

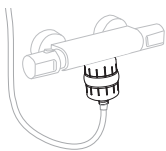

Acqua filtrata senza cloro anche nella doccia.

Ideale per persone allergiche al cloro.

Durante la doccia il cloro, che è tossico, viene assorbito dalla pelle. Il nostro filtro riduce sino ad un 99% la quantità d'impurità, sedimenti, odore e cloro.

Filtered chlorine-free water also in the shower Chlorine.

Ideal for those allergic to chlorine.

A toxic substance, is absorbed by the skin when showering. Our filter reduces the amount of impurities, sediment, odour and chlorine by up to 99%.

Filtrovaná voda bez chlóru i ve sprše.

Vhodné pro osoby alergické na chlor.

Chlór se při sprchování vstřebává do kůže a je toxický. Tento filtr redukuje množství nečistot, usazenin, zápach a chlór až z 99 %.

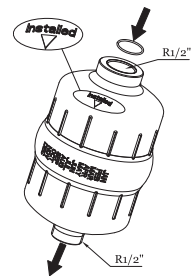

Acqua filtrata fino a 10.000 litri.

Filtering water up to 10.000 litres.

Účinná filtrace až do 10.000 litrů vody.







CUADRO-TRES



Lavabi
Basin mixer taps
Koupelňová baterie
378



Bidet
Bidets
Bidety
387



Monocomando esterno
Bathtub mixer taps
Jednopákový mechanismus vany
388



Monocomando ad incasso
Built-in sets
Vestavěné soupravy
389



Bordovasca
Deck-mounted bathtubs
Vany s prodlouženým pultem
391



Termostatica esterna
Thermostatically-controlled
Termostatické
392



Accessori
Accessories
Vybavení
345

www.tresgriferia.com



**RICAMBI SU
SPARE PARTS AT
NÁHRADNÍ DÍLY NA**
www.tresgriferia.com



Monocomando lavabo

con bocca a cascata. * NOTA: La rubinetteria con canna a cascata è accompagnata da 2 rubinetti di regolazione con filtro (Ref: 91.34.525)

Single lever washbasin mixer

with cascade cast spout. * NOTE: Taps with a cascade spout come with 2 regulation valves and a filter (Nr.: 91.34.525)

Jednopáková umyvadlová baterie

ramínko s vodopádem. * POZNÁMKA: Baterie typu vodopádu je doplněna dvěma regulačními kohouty s filtrem (Kód: 91.34.525)

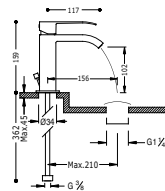

299.190.01
Cr **006.101.01**



299.190.01
Cr **006.101.01.D**

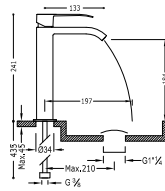

299.190.01
Cr **006.610.01**

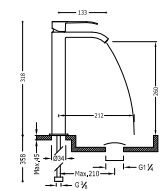

299.190.01
Cr **006.810.01**

Monocomando lavabo

con bocca a cascata aperta. * NOTA: La rubinetteria con canna a cascata è accompagnata da 2 rubinetti di regolazione con filtro (Ref: 91.34.525)

Single lever washbasin mixer

with open cascade spout. * NOTE: Taps with a cascade spout come with 2 regulation valves and a filter (Nr.: 91.34.525)

Jednopáková umyvadlová baterie

ramínko s otevřeným vodopádem. * POZNÁMKA: Baterie typu vodopádu je doplněna dvěma regulačními kohouty s filtrem (Kód.: 91.34.525)

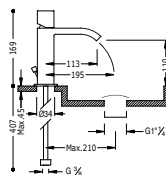

299.190.02
Cr 006.110.02



299.190.02
Cr 006.110.02.D

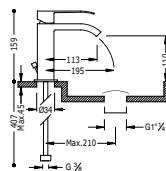

299.190.02
Cr 006.110.01



299.190.02
Cr 006.110.01.D

Monocomando lavabo

con bocca a cascata. NOTA: La rubinetteria con canna a cascata è accompagnata da 2 rubinetti di regolazione con filtro (Ref: 91.34.525)

Single lever washbasin mixer

with cascade cast spout. NOTE: Taps with a cascade spout come with 2 regulation valves and a filter (Nr.: 91.34.525)

Jednopáková umyvadlová baterie

ramínko s vodopádem. POZNÁMKA: Baterie typu vodopádu je doplněna dvěma regulačními kohouty s filtrem (Kód.: 91.34.525)

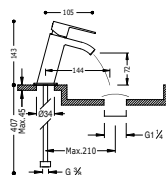

299.190.01
Cr 006.201.01



Ref. / Nr. / Kód: |

Monocomando lavabo
Single lever washbasin mixer
Jednopáková umyvadlová baterie

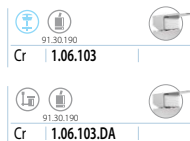
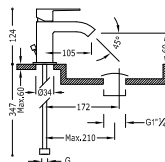
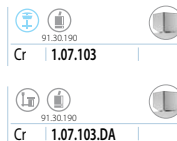
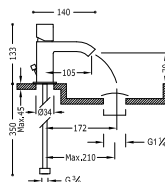

Monocomando lavabo
canna 34x10 mm.
Single lever washbasin mixer
spout 34x10 mm.
Jednopáková umyvadlová baterie
ramínko 34x10 mm

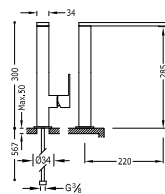
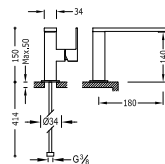
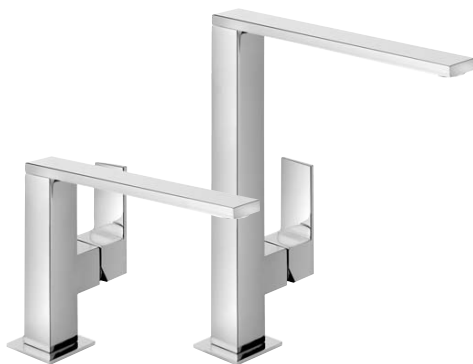

Monocomando lavabo
canna 35x15 mm.

Single lever washbasin mixer
spout 35x15 mm.

Jednopáková umyvadlová baterie
ramínko 35x15 mm

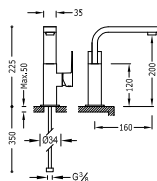

Cr 1.06.603

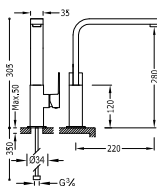

Cr 1.06.604

Monocomando lavabo
canna 22x22 mm.

Single lever washbasin mixer
spout 22x22 mm.

Jednopáková umyvadlová baterie
ramínko 22x22 mm

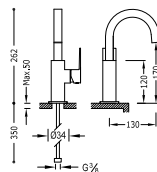

Cr 1.06.605

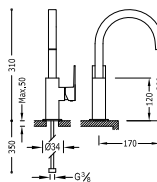

Cr 1.06.606

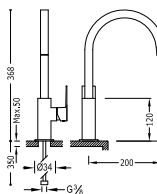

Cr 1.06.607



Ref. / Nr. / Kód: |

Monoblocco verticale
canna 35x15 mm.

Single hole mixer
spout 35x15 mm

Dvoupáková svislá baterie
ramínko 35x15 mm

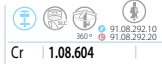
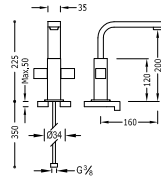

Cr | 1.08.604

Monoblocco verticale
canna 22x22 mm.

Single hole mixer
spout 22x22 mm.

Dvoupáková svislá baterie
ramínko 22x22 mm

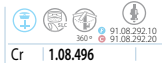
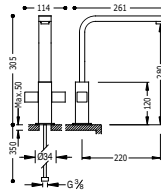

Cr | 1.08.496

Monoblocco verticale
canna 22x22 mm.

Single hole mixer
spout 22x22 mm.

Dvoupáková svislá baterie
ramínko 22x22 mm

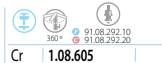
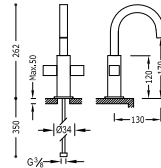

Cr | 1.08.605

Monoblocco verticale
canna 22x22 mm.

Single hole mixer
spout 22x22 mm.

Dvoupáková svislá baterie
ramínko 22x22 mm

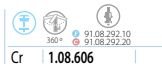
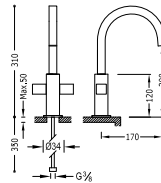

Cr | 1.08.606

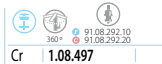
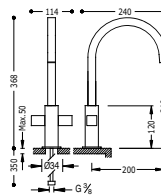

Cr | 1.08.497

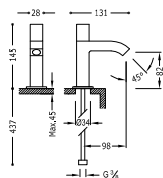

Rubinetto lavandino 1 acqua o premiscelata
1 water or premixed bathroom tap
 Umyvadlová baterie pro jednu nebo předem smíchanou vodu



91.08.295.10

Cr **1.07.503** |

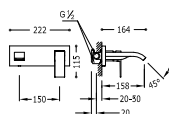

Monomando a muro
 con bocca a cascata
**Single lever wall washbasin mixer
 with cascade cast spout**

Jednopáková nástěnná baterie
 ramínko s vodopádem



299.190.01

Cr **006.260.01** |

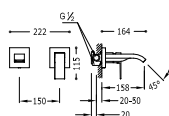

Monomando a muro
 con bocca a cascata
**Single lever wall washbasin mixer
 with cascade cast spout**

Jednopáková nástěnná baterie
 ramínko s vodopádem



299.190.01

Cr **006.260.10** |

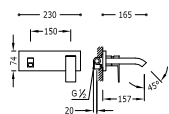

Monomando a muro
 con aeratore
**Single lever wall washbasin mixer
 with aerator**

Jednopáková nástěnná baterie
 s perlátorem



91.30.190

Cr **1.06.200** |

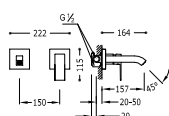

Monomando a muro
 con aeratore
**Single lever wall washbasin mixer
 with aerator**
 Jednopáková umyvadlová nástěnná baterie
 s perlátorem



91.30.190

Cr **006.200.10** |

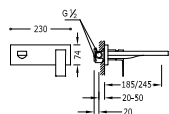

Monomando a muro
Single lever wall washbasin mixer
 Jednopáková nástěnná baterie



91.30.190 (185 mm.)

Cr **006.200.03** |



91.30.190 (245 mm.)

Cr **006.200.04** |



Ref. / Nr. / Kód: |

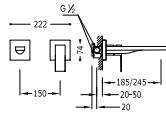

Monomando a muro
Single lever wall washbasin mixer
Jednopáková nástěnná baterie

91.30.190 (185 mm.)
Cr **006.200.12**

91.30.190 (245 mm.)
Cr **006.200.11**

Monocomando lavabo a mensola
canna 22x22 mm.

Deck-mounted washbasin mixer tap
spout 22x22 mm.

Páková baterie k umyvadlu
ramínko 22x22 mm

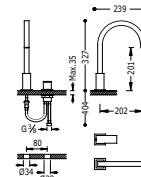

360° 91.30.190
Cr **006.105.03**

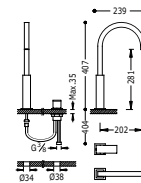

360° 91.30.190
Cr **006.105.04**

Monoblocco a muro
con bocca a cascata

Single hole wall mixer
with cascade cast spout

Nástěnná umyvadlová baterie
ramínko s kaskádou

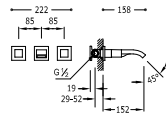

91.34.202
Cr **008.152.01**

Monoblocco a muro
con aeratore

Single hole wall mixer
with aerator

Nástěnná umyvadlová baterie
s perlátorem

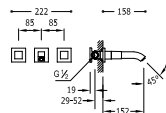

91.34.282
Cr **008.151.01**

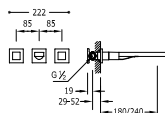

Monoblocco a muro
Single hole wall mixer
Nástěnná umyvadlová baterie



Cr **008.153.01**



Cr **008.154.01**

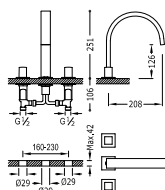

Doppio comando a mensola
canna tubo 35x15 mm. Aeratore rettangolare

Counter-top dual control tap
Tube spout 35x15 mm. Rectangular Aerator

Kohoutková stojánková vanová baterie
ramínko 35x15 mm se skrytým obdĺnikovým perlátorem



Cr **008.105.01**

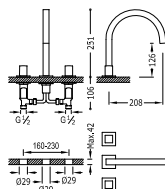

Doppio comando a mensola
canna tubo 22x22 mm.

Counter-top dual control tap
Tube spout 22x22 mm.

Kohoutková stojánková vanová baterie
ramínko 22x22 mm.



Cr **008.105.02**

Doppio comando a mensola
canna 22x22 mm.

Counter-top dual control tap
spout 22x22 mm.

Kohoutková stojánková vanová baterie
ramínko 22x22 mm

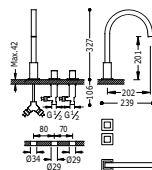

Cr **008.105.03**

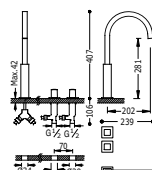

Cr **008.105.04**



Monocomando bidet
Single lever bidet mixer
Jednopáková bidetová baterie

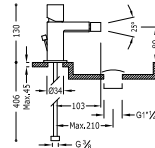

Cr	91.30.190	
	007.120.01	
Cr	91.30.190	
	007.120.01.D	

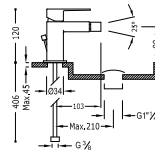

Cr	91.30.190	
	006.120.01	
Cr	91.30.190	
	006.120.01.D	

Monocomando bidet
Single lever bidet mixer
Jednopáková bidetová baterie

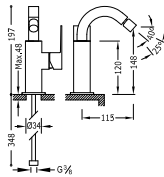

Cr	360 + 91.30.190	
	1.06.124	

Monoblocco bidet
Single hole bidet mixer
Dvoupáková bidetová baterie

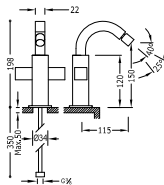

Cr	91.08.292.10 91.08.292.20	
	1.08.124	

Monocomando bidet con doccia
Bidet mixer tap with small shower head
Jednopáková bidetová baterie se sprškou

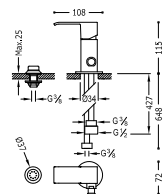

Cr	91.30.190	
	006.130.01	

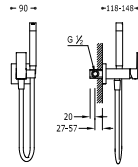

Monocomando ad incasso per bidé WC
Supporto a destra o a sinistra, intercambiabile. Flesso satinato. *
Opzione Cartongesso

Concealed single lever bidet/toilets
Left or right support, interchangeable. Sateen hose. * Opție gips

Jednopáková podomítková baterie pro bidet WC
Vyměnitelný držák zprava či zleva. Sprchová mosazná baterie
s omezovacím hrdlem s l/m. Systém proti kapání a flexi hadice
SATIN. * Možnost pro sádrokartonové panely



91.30.190

Cr 006.123.01

Cr 006.123.02*

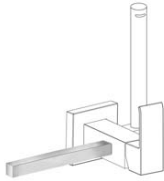

Accessori portasciugamani
180 mm. (per ref.: 006.123.01, 006.123.02). NOTA: Supporto a destra
o a sinistra, intercambiabile.

Accessory towel racks
180 mm. (for Nr.: 006.123.01, 006.123.02). NOTE: Left or right
support, interchangeable.

Příslušenství držák na ručníky
180 mm. (Kód: 006.123.01, 006.123.02). POZNÁMKA: Pravý nebo
levý podstavec, vyměnitelný.

Cr 034.124.02

MONOCOMANDI BAGNO / BATHTUB MIXER TAPS / JEDNOPÁKOVÝ MECHANISMUS VANY

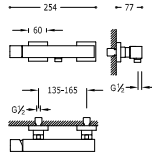

Monocomando doccia
Doccetta anticalcare (006.639.01) con supporto orientabile.
Flessibile satin (91.34.609.15).

Single lever shower mixer
Anti-limescale hand shower (006.639.01) with directable support.
Shower hose satin (91.34.609.15).

Jednopáková sprchová baterie
Ruční sprcha (006.639.01) s nastavitelným držákem, proti usaz.
vod. kamene a flexi hadici SATIN (91.34.609.15)



91.30.190

Cr 1.07.167

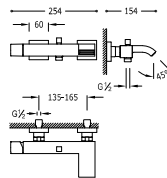

Monocomando vasca
Con bocca a cascata. Doccetta anticalcare (006.639.01) con
supporto orientabile. Flessibile satin (91.34.609).

Single lever bath and shower mixer
with cascade. Anti-limescale hand shower (006.639.01) with
directable support. Shower hose satin (91.34.609).

Jednopáková baterie pro vanu-sprchu
s kaskádou. Ruční sprcha (006.639.01) s nastavitelným držákem,
proti usaz. vod. kamene. Flexi hadice SATIN (91.34.609).



91.30.190

Cr 1.07.170.02

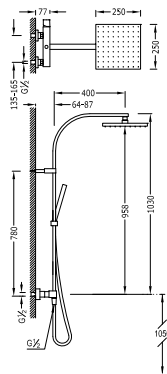

Kit doccia
· Doccia fissa 250x250 mm. con snodo. (1.34.138.26).
· Doccetta anticalcare (006.639.01).
· Flessibile satin (91.34.609.15).

Concealed shower set
· Fixed shower head 250x250 mm. with ball joint. (1.34.138.26).
· Antilime hand shower (006.639.01)
· Satin hose (91.34.609.15).

Sprchová souprava, proti usaz. vod. kamene
· Pevná sprcha 250x250 mm. s kloubem. (1.34.138.26).
· Ruční sprcha, proti usaz. vod. kamene (006.639.01).
· Flexi hadice SATIN (91.34.609.15).



91.30.190

Cr 007.191.01



GRUPPI AD INCASSO / BUILT-IN SETS / VESTAVĚNÉ SOUPRAVY

Ref. / Nr. / Kód:

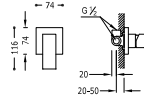

Monocomando incasso (1 vie)
corpo incassato incluso

Built-in mixer taps (1 way)
Built-in body included

Vestavěná jednopáková sprchová baterie (jednocestná)
včetně podomítkového tělesa

91.30.190
Cr | 1.06.177

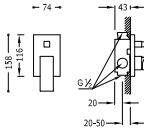

Monocomando incasso (2 vie)
corpo incassato incluso

Built-in mixer taps (2 way)
Built-in body included

Vestavěná jednopáková baterie (dvoucestná)
včetně podomítkového tělesa

91.30.190
Cr | 1.06.180



Prolunga per monocomando incasso doccia
Extension for built-in shower mixer tap
Nástavec pro vestavěnou jednopákovou sprchu

Cr | 1.06.177.10

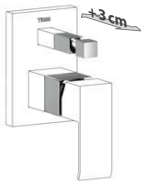

Prolunga per monocomando incasso bagno-doccia
Extension for built-in bathtub-shower mixer tap
Nástavec pro vestavěnou jednopákovou vanu/sprchu

Cr | 1.06.180.10

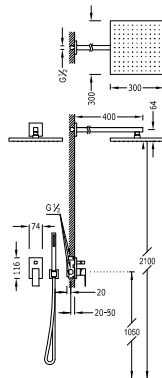

Kit doccia ad incasso

- Con chiusura e regolazione di portata.
- Corpo incassato incluso
- Doccia fissa 300x300 mm, con snodo. Ottone (1.34.138.30).
- Supporto per doccia (006.182.01).
- Doccetta anticalcare (006.639.01).
- Flessibile satin. (91.34.609.15).

Concealed shower set

- with water shut off and flow control.
- Built-in body included
- Fixed shower head 300x300 mm. with ball joint. Brass. (1.34.138.30).
- Elbow wall (006.182.01).
- Anti-lime hand shower (006.639.01).
- Satin hose (91.34.609.15).

Podomítkový jednopákový sprchový set
s uzávěrem a regulací průtoku.

- Včetně podomítkového tělesa
- Pevná sprcha 300x300 mm. s kloubem. Materiál mosaz. (1.34.138.30).
- Držák s nástěnným příívodem vody (006.182.01).
- Ruční sprcha, proti usaz. vod. kamene (006.639.01).
- Flexi hadice SATIN (91.34.609.15).

91.30.190
Cr | 1.06.980

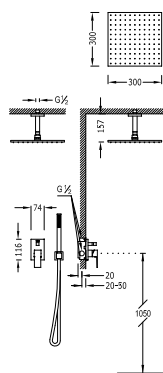

Kit doccia ad incasso

Con chiusura e regolazione di portata.

- Corpo incassato incluso
- Doccia fissa 300x300 mm. con snodo. Ottone (1.34.138.30).
- Supporto per doccia (006.182.01).
- Doccetta anticalcare (006.639.01).
- Flessibile satin (91.34.609.15).

Concealed shower set

with water shut off and flow control.

- Built-in body included
- Fixed shower head 300x300 mm. with ball joint. Brass. (1.34.138.30).
- Elbow wall (006.182.01).
- Antilime hand shower (006.639.01).
- Satin hose (91.34.609.15).

Podomítkový jednopákový sprchový set

s uzávěrem a regulací průtoku.

- Včetně podomítkového tělesa
- Pevná sprcha 300x300 mm. s kloubem. Materiál mosaz. (1.34.138.30).
- Držák s nástěnným přívodem vody (006.182.01).
- Ruční sprcha, proti usaz. vod. kamene (006.639.01).
- Flexi hadice SATIN (91.34.609.15).



91.30.190

Cr 006.180.80

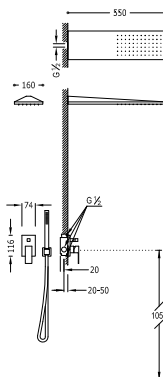

Kit doccia ad incasso

Con chiusura e regolazione di portata.

- Corpo incassato incluso
- Doccia acciaio inossidabile da parete 160x550 mm. (299.903.03).
- Supporto per doccia (006.182.01).
- Doccetta anticalcare (006.639.01).
- Flessibile satin (91.34.609.15).

Concealed shower set

with water shut off and flow control.

- Built-in body included
- Stainless steel wall shower 160x550 mm. (299.903.03).
- Elbow wall (006.182.01).
- Antilime hand shower (006.639.01).
- Satin hose (91.34.609.15).

Podomítkový jednopákový sprchový set

s uzávěrem a regulací průtoku.

- Včetně podomítkového tělesa
- Nástěnné sprchové křepitko z nerez. oceli 160x550 mm (299.903.03).
- Držák s nástěnným přívodem vody. (006.182.01).
- Ruční sprcha, proti usaz. vod. kamene (006.639.01).
- Flexi hadice SATIN (91.34.609.15).



91.30.190

Cr 006.180.03

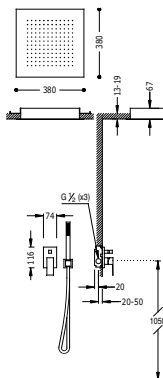

Kit doccia ad incasso

Con chiusura e regolazione di portata.

- Corpo incassato incluso
- Soffione doccia acciaio inossidabile 380x380 mm. (1.34.944).
- Supporto per doccia (006.182.01).
- Doccetta anticalcare (006.639.01).
- Flessibile satin (91.34.609.15).

Concealed shower set

with water shut off and flow control.

- Built-in body included
- Steel shower head 380x380 mm. (1.34.944).
- Elbow wall (006.182.01).
- Antilime hand shower (006.639.01).
- Satin hose (91.34.609.15).

Podomítkový jednopákový sprchový set

s uzávěrem a regulací průtoku.

- Včetně podomítkového tělesa
- Sprchové křepitko z nerez. oceli 380x380 mm. (1.34.944).
- Držák s nástěnným přívodem. (006.182.01).
- Ruční sprcha, proti usaz. vod. kamene (006.639.01).
- Flexi hadice SATIN (91.34.609.15).



91.30.190

Cr 006.980.01



TERMOSTATICHE / THERMOSTATICALLY-CONTROLLED / TERMOSTATICKÉ

Ref. / Nr. / Kód:

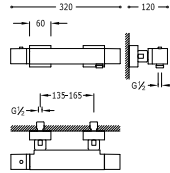

Doccia termostatica

(Doccetta anticalcare con supporto orientabile. Flesso satinato (91.34.609.15)).

Wall thermostatic shower mixer

(Anti-limescale hand shower with directable support. Shower hose satin (91.34.609.15)).

Termostatická sprchová baterie

(Ruční sprcha s nastavitelným držákem, proti usaz. vod. kamene. Flexi hadice SATIN (91.34.609.15))



91.06.161.10
Cr **1.07.164**

91.06.161.10
Cr **1.07.164,9**

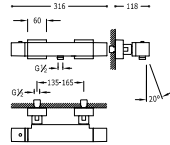

Vasca-Doccia termostatica

Con bocca a cascata (Doccetta anticalcare con supporto orientabile. Flesso satinato (91.34.609)).

Wall thermostatic bath and shower mixer with cascade (Anti-limescale hand shower with directable support. Shower hose satin (91.34.609)).

Termostatická baterie pro vanu-sprchu

s kaskádou (Ruční sprcha s nastavitelným držákem, proti usaz. vod. kamene. Flexi hadice SATIN (91.34.609))



91.06.161.10
Cr **1.07.174**

91.06.161.10
Cr **1.07.174,9**

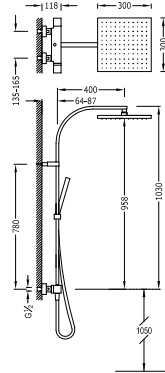

Set doccia termostatica

· Doccia fissa 300x300 mm. con snodo. Ottone (1.34.138.30).
· Doccetta anticalcare (006.639.01).
· Flessibile satin (91.34.609.15).
· Invertitore integrato nel regolatore di portata.

Wall thermostatic shower mixer

· Fixed shower head 300x300 mm. with ball joint. Brass (1.34.138.30).
· Antilime hand shower (006.639.01).
· Satin hose (91.34.609.15).
· Diverter integrated in the flow control.

Souprava termostatické sprchové baterie

· Pevná sprcha 300x300 mm. s kloubem. Materiál mosaz (1.34.138.30).
· Ruční sprcha, proti usaz. vod. kamene (006.639.01)
· Flexi hadice SATIN (91.34.609.15).
· Přepínač zabudovaný v regulaci průtoku.



91.06.161.10
Cr **1.07.395**

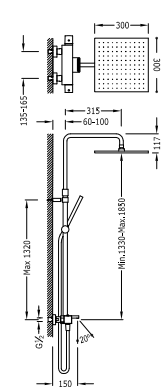

Idrodoccia termostatica

· Doccia fissa 300x300 mm. con snodo. (1.34.138.30). Ottone.
· Doccetta anticalcare (006.639.01).
· Flessibile satin (91.34.609).
· Asta telescopica.

Wall thermostatic bath mixer

· Fixed shower head 300x300 mm. with ball joint. (1.34.138.30). Brass.
· Antilime hand shower (006.639.01).
· Satin hose (91.34.609).
· Telescopic bar.

Souprava termostatické baterie pro vanu-sprchu

· Pevná sprcha 300x300 mm. s kloubem. Materiál mosaz (1.34.138.30).
· Ruční sprcha proti usaz. vod. kamene (006.639.01)
· Flexi hadice SATIN (91.34.609).
· Teleskopická tyč.



299.321.01
Cr **007.312.01**



RUBINETTI DI ARRESTO / SHUTOFF VALVES / PRŮCHOZÍ VENTILY

Ref. / Nr. / Kód:

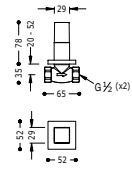

Rubinetto di arresto filettato 1/2"
1/2" threaded-ends gate-valve
Uzavírací ventil 1/2"

Cr 007.155.01

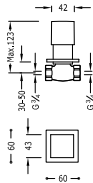

Rubinetto di arresto filettato 3/4"
3/4" threaded-ends gate-valve
Uzavírací ventil 3/4"

Cr 1.07.511





MAX-TRES



Lavabi
Basin mixer taps
Koupelňová baterie
396



Bidets
Bidets
Bidety
405



Monocomando esterno
Bathtub mixer taps
Jednopákový mechanismus vany
407



Monocomando ad incasso
Built-in sets
Vestavné soupravy
408



Bordovasca
Deck-mounted bathtubs
Vany s prodlouženým pultem
410



Termostatica esterna
Thermostatically-controlled
Termostatické
412



Accessori
Accessories
Vybavení
346

www.tresgriferia.com



**RICAMBI SU
SPARE PARTS AT
NÁHRADNÍ DÍLY NA**
www.tresgriferia.com

Monocomando lavabo
Single lever washbasin mixer
Jednopáková umyvadlová baterie

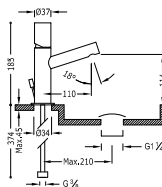

91.07.190.05		
Cr	061.103.01	131,00

91.07.190.05		
Cr	061.103.01.D	150,00

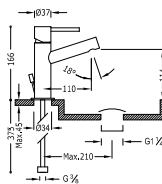

91.07.190.05		
Cr	062.103.01	131,00

91.07.190.05		
Cr	062.103.01.D	150,00

Monocomando lavabo
canna lunga

Single lever washbasin mixer
long spout

Jednopáková umyvadlová baterie
dlouhé ramínko

MISURE SPECIALI / EXCEPTIONAL MEASURES / NESTANDARDNÍ ROZMERY

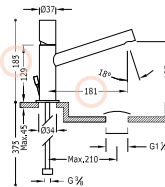

Cr 061.203.01 | 155,00



Cr 061.203.01.D | 174,00

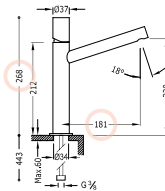

Cr 061.206.01 | 204,00

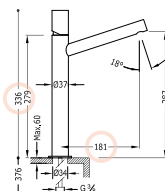

Cr 061.207.01 | 227,00

Monocomando lavabo
canna lunga

Single lever washbasin mixer
long spout

Jednopáková umyvadlová baterie
dlouhé ramínko

MISURE SPECIALI / EXCEPTIONAL MEASURES / NESTANDARDNÍ ROZMERY

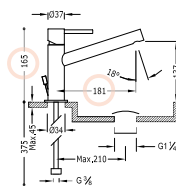

91 07.190.05
Cr **062.203.01** | **155,00**

91 07.190.05
Cr **062.203.01.D** | **174,00**

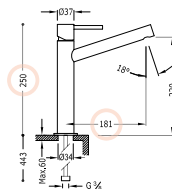

91 07.190.05
Cr **062.206.01** | **204,00**

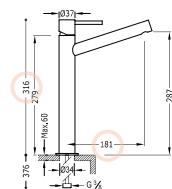

91 07.190.05
Cr **062.207.01** | **227,00**

Monocomando lavabo

NOTA: La rubinetteria con canna a cascata è accompagnata da 2 rubinetti di regolazione con filtro (Ref. 91.34.525)

Single lever washbasin mixer

NOTE: Taps with a cascade spout come with 2 regulation valves and a filter (Nr.: 91.34.525)

Jednopáková umyvadlová baterie

POZNÁMKA: Baterie typu vodopádu je doplněna dvěma regulačními kohouty s filtrem (Kód.: 91.34.525)

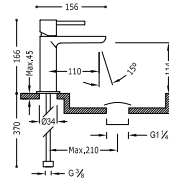
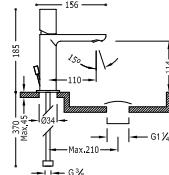

Cr	061.103.02		117,00
Cr	061.103.02.D		136,00
Cr	061.103.03		136,00
Cr	061.103.03.D		154,00

Cr	062.103.02		117,00
Cr	062.103.02.D		136,00
Cr	062.103.03		136,00
Cr	062.103.03.D		154,00

Monocomando lavabo

con bocca a cascata aperta. NOTA: La rubinetteria con canna a cascata è accompagnata da 2 rubinetti di regolazione con filtro (Ref. 91.34.525)

Single lever washbasin mixer

with open cascade spout. NOTE: Taps with a cascade spout come with 2 regulation valves and a filter (Nr.: 91.34.525)

Jednopáková umyvadlová baterie

ramínko s otevřeným vodopádem. POZNÁMKA: Baterie typu vodopádu je doplněna dvěma regulačními kohouty s filtrem (Kód.: 91.34.525)

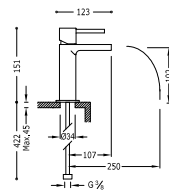
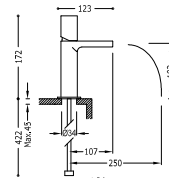

Cr	061.110.01		195,00

Cr	062.110.01		195,00

Monocomando lavabo

NOTA: La rubinetteria con canna a cascata è accompagnata da 2 rubinetti di regolazione con filtro (Ref: 91.34.525)

Single lever washbasin mixer

NOTE: Taps with a cascade spout come with 2 regulation valves with a filter (Nr.: 91.34.525)

Jednopáková umyvadlová baterie

POZNÁMKA: Baterie typu vodopádu je doplněna dvěma regulačními kohouty s filtrem (Kód: 91.34.525)

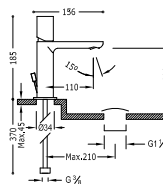

Cr	061.103.02	117,00
Cr	061.103.02.D	136,00
Cr	061.103.03	136,00
Cr	061.103.03.D	154,00

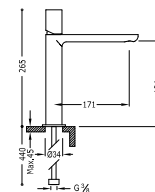

Cr	061.203.04	210,00

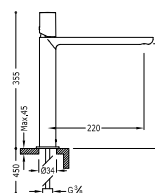

Cr	061.203.06	233,00

Monocomando lavabo

NOTA: La rubinetteria con canna a cascata è accompagnata da 2 rubinetti di regolazione con filtro (Ref: 91.34.525)

Single lever washbasin mixer

NOTE: Taps with a cascade spout come with 2 regulation valves and a filter (Nr.: 91.34.525)

Jednopáková umyvadlová baterie

POZNÁMKA: Baterie typu vodopádu je doplněna dvěma regulačními kohouty s filtrem (Kód: 91.34.525)

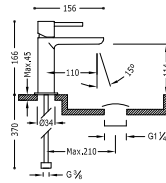

Cr	91.30.190 062.103.02	117,00
Cr	91.30.190 062.103.02.D	136,00
Cr	91.30.190 062.103.03	136,00
Cr	91.30.190 062.103.03.D	154,00

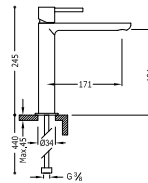

Cr	91.30.190 062.203.04	210,00

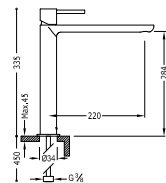

Cr	91.30.190 062.203.06	233,00

Monocomando lavabo
canna 34x9 mm.

Single lever washbasin mixer
spout 34x9 mm.

Jednopáková umyvadlová baterie
ramínko 34x9 mm

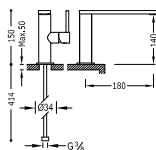

Cr 062.905.03 | 173,00

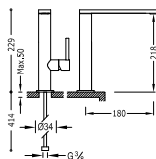

Cr 360° 91.30.190 | 190,00

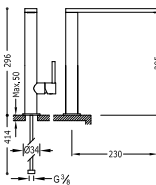

Cr 360° 91.50.190 | 227,00

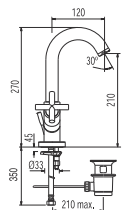

Monoblocco lavabo

Single hole wash-basin mixer

Dvoupáková umyvadlová baterie



Cr 360° 1.63.103 | 216,00



Cr 1.68.103 | 234,00

Lavabo elettronico 1 acqua TOUCH-TRES

Sistema sensibile al tatto. Senza premere.

TOUCH-TRES 1 water electronic tap

Sensitive system to the touch. No press.

Elektronická baterie na 1 vodu TOUCH-TRES

Dotyková. Pouze na dotek (NESMÍ se stisknout)

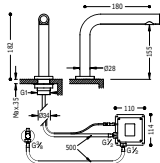

Cr 061.447.01 | 219,00

Lavabo elettronico miscelatore TOUCH-TRES

Sistema sensibile al tatto. Senza premere. NOTA: include un rubinetto miscelatore a due acque con tubi flessibili (per ref.: 1.92.507.30).

TOUCH-TRES electronic mixer tap

Sensitive system to the touch. No press. NOTE: Includes a hot and cold mixer tap with flexible pipes (for Nr.: 1.92.507.30).

Elektronická baterie směsná TOUCH-TRES

Dotyková. Pouze na dotek (NESMÍ se stisknout). POZNÁMKA: Obsahuje směsnou baterii pro teplou i studenou vodu s ohebnými hadicemi (Kód: 1.92.507.30).

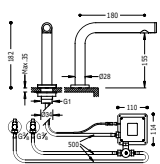

Cr 061.448.01 | 264,00

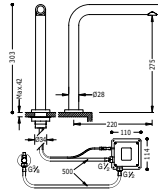

Lavabo elettronico 1 acqua TOUCH-TRES
Sistema sensibile al tatto. Senza premere.

TOUCH-TRES 1 water electronic tap
Sensitive system to the touch. No press.

Elektronická baterie na 1 vodu TOUCH-TRES
Dotyková. Pouze na dotek (NESMÍ se stisknout)



Cr | 1.61.445 | 253,00

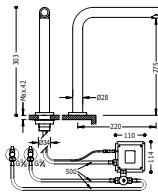

Lavabo elettronico miscelatore TOUCH-TRES
Sistema sensibile al tatto. Senza premere. NOTA: include un rubinetto miscelatore a due acque con tubi flessibili (per ref.: 1.92.507.30).

TOUCH-TRES electronic mixer tap
Sensitive system to the touch. No press. NOTE: Includes a hot and cold mixer tap with flexible pipes (for Nr.: 1.92.507.30).

Elektronická baterie směsná TOUCH-TRES
Dotyková. Pouze na dotek (NESMÍ se stisknout). POZNÁMKA: Obsahuje směsnou baterii pro teplou i studenou vodu s ohebnými hadicemi (Kód: 1.92.507.30).

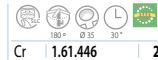

Cr | 1.61.446 | 298,00

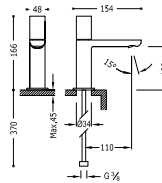

Rubinetto lavandino 1 acqua o premiscelata
1 water or premixed bathroom tap
Umyvadlová baterie pro jednu nebo předem smíchanou vodu



Cr | 200.503.01 | 105,00

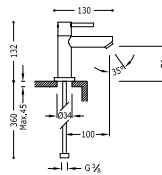

Rubinetto lavandino 1 acqua o premiscelata
1 water or premixed bathroom tap
Umyvadlová baterie pro jednu nebo předem smíchanou vodu



Cr | 1.62.503 | 105,00

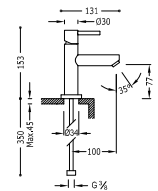

Monocomando lavabo Ø 30 mm.
Single lever washbasin mixer Ø 30 mm.
Jednopáková umyvadlová baterie Ø 30 mm



Cr | 1.62.603 | 117,00

Monomando a muro
Single lever wall washbasin mixer
Jednopáková nástěnná baterie

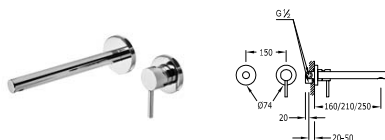

91.30.190 (160 mm.)
Cr | 062.200.70 | 203,00

91.30.190 (210 mm.)
Cr | 062.200.71 | 209,00

91.30.190 (250 mm.)
Cr | 062.200.03 | 214,00

Monomando a muro
Single lever wall washbasin mixer
Jednopáková nástěnná baterie

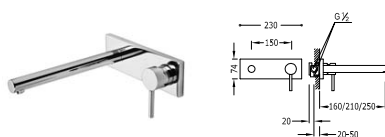

91.34.592 (160 mm.)
Cr | 062.200.01 | 236,00

91.34.592 (210 mm.)
Cr | 062.200.02 | 242,00

91.34.592 (250 mm.)
Cr | 1.62.200 | 248,00

Monomando a muro
con bocca a cascata
Single lever wall washbasin mixer
with cascade cast spout

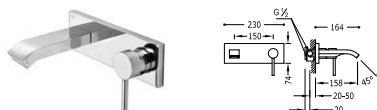

Jednopáková nástěnná baterie
ramínko s vodopádem

299.190.01
Cr | 062.260.10 | 293,00

Accumulatore lavabo a muro
Wash-basin mixer
Nástěnná umyvadlová baterie

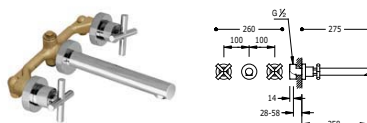

91.34.282 (160 mm.)
Cr | 1.63.152 | 272,00

91.34.282 (250 mm.)
Cr | 1.63.151 | 283,00

Accumulatore lavabo
Wash-basin mixer
Umyvadlová baterie



360+
Cr | 1.68.105 | 354,00

Monocomando bideet
Single lever bideet mixer
Jednopáková bideetová baterie

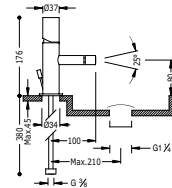

91.07.190.05
Cr | **061.120.01** | **131,00**

91.07.190.05
Cr | **061.120.01.D** | **150,00**

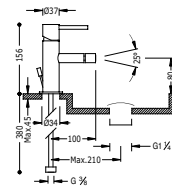

91.07.190.05
Cr | **062.120.01** | **131,00**

91.07.190.05
Cr | **062.120.01.D** | **150,00**

Monocomando bideet
Single lever bideet mixer
Jednopáková bideetová baterie

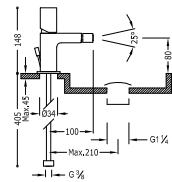

91.30.190
Cr | **061.220.01** | **117,00**

91.30.190
Cr | **061.220.01.D** | **136,00**

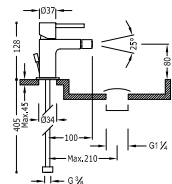

91.30.190
Cr | **062.220.01** | **117,00**

91.30.190
Cr | **062.220.01.D** | **136,00**

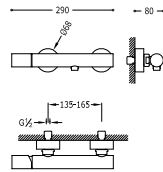

Monocomando doccia
Doccetta anticalcare (299.748.02) con supporto orientabile.
Flessibile satin (91.34.609.15).

Single lever shower mixer
Anti-limescale hand shower (299.748.02) with directable support.
Shower hose satin (91.34.609.15).

Sprchová baterie
Ruční sprcha (299.748.02) s nastavitelným držákem, proti usaz. vod. kamene a flexi hadice SATIN (91.34.609.15).

91.30.190
Cr 061.167.01 208,00

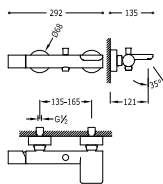

Monocomando vasca
Con bocca a cascata. Doccetta anticalcare (299.748.02) con supporto orientabile. Flessibile satin (91.34.609.15).

Single lever bath and shower mixer
with cascade. Anti-limescale hand shower (299.748.02) with directable support. Shower hose satin (91.34.609.15).

Vanová baterie
s kaskádou. Ruční sprcha (299.748.02) s nastavitelným držákem, proti usaz. vod. kamene a flexi hadice SATIN (91.34.609.15).

91.30.190
Cr 061.170.01 232,00

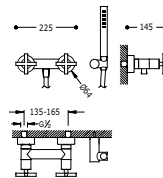

Gruppo doccia
Doccetta anticalcare (034.116.01) con supporto orientabile.
Flessibile satin (91.34.609.15).

Shower mixer
Anti-limescale hand shower (034.116.01) with directable support.
Shower hose satin (91.34.609.15).

Sprchový set
Ruční sprcha s nastavitelným držákem (034.116.01), proti usaz. vod. kamene a flexi hadice SATIN (91.34.609.15).

91.30.190
Cr 1.63.868 275,00

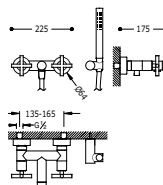

Gruppo vasca
Doccetta anticalcare (034.116.01) con supporto orientabile.
Flessibile satin (91.34.609.15).

Bath and shower mixer
Anti-limescale hand shower (034.116.01) with directable support.
Shower hose satin (91.34.609.15).

Vanový set
Ruční sprcha s nastavitelným držákem (034.116.01), proti usaz. vod. kamene a flexi hadice SATIN (91.34.609.15).

91.30.190
Cr 1.63.874 348,00

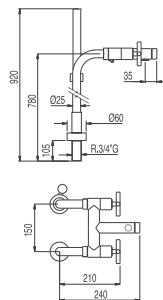

Gruppo vasca con presa a pavimento
Doccetta anticalcare (034.116.01) con supporto orientabile.
Flessibile satin (91.34.609.15).

Bath & shower mixer with connections to the floor
Anti-limescale hand shower (034.116.01) with directable support.
Shower hose satin (91.34.609.15).

Vanový set s podlahovými přívody
Ruční sprcha s nastavitelným držákem (034.116.01), proti usaz. vod. kamene a flexi hadice SATIN (91.34.609.15).

91.30.190
Cr 1.63.194 624,00

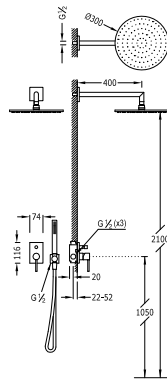

Kit doccia ad incasso

Con chiusura e regolazione di portata.

- Corpo incassato incluso
- Doccia fissa Ø 300 mm, con snodo. (1.34.137.30). Ottone.
- Supporto per doccia (061.182.01).
- Doccetta anticalcare (034.116.01).
- Flessibile satin (91.34.609.15).

Concealed shower set

with water shut off and flow control.

- Built-in body included
- Fixed shower head Ø 300 mm, with ball joint. (1.34.137.30). Brass.
- Elbow wall (061.182.01).
- Antilime hand shower (034.116.01).
- Satin hose (91.34.609.15).

Podomítkový jednopákový sprchový set

s uzávěrem a regulací průtoku.

- Včetně podomítkového tělesa
- Pevná sprcha Ø 300 mm, s kloubem. (1.34.137.30). Materiál mosaz.
- Držák s nástěnným přívodem vody (061.182.01).
- Ruční sprcha, proti usaz. vod. kamene (034.116.01).
- Flexi hadice SATIN (91.34.609.15).



91.30.190

Cr 062.980.01

481,00



N

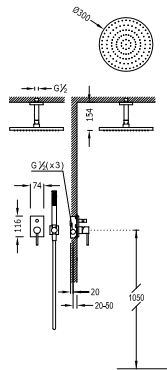

Kit doccia ad incasso

Con chiusura e regolazione di portata.

- Corpo incassato incluso
- Doccia fissa Ø 300 mm, con snodo. (1.34.137.30). Ottone.
- Supporto per doccia (061.182.01).
- Doccetta anticalcare (034.116.01).
- Flessibile satin (91.34.609.15).

Concealed shower set

with water shut off and flow control.

- Built-in body included
- Fixed shower head Ø 300 mm, with ball joint. (1.34.137.30). Brass.
- Elbow wall (061.182.01).
- Antilime hand shower (034.116.01).
- Satin hose (91.34.609.15).

Podomítkový jednopákový sprchový set

s uzávěrem a regulací průtoku.

- Včetně podomítkového tělesa
- Pevná sprcha Ø 300 mm, s kloubem. (1.34.137.30). Materiál mosaz.
- Držák s nástěnným přívodem vody (061.182.01).
- Ruční sprcha, proti usaz. vod. kamene (034.116.01).
- Flexi hadice SATIN (91.34.609.15).



91.30.190

Cr 062.180.80

461,00

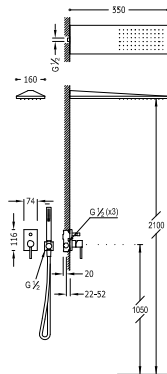

Kit doccia ad incasso

Con chiusura e regolazione di portata.

- Corpo incassato incluso
- Doccia acciaio inossidabile da parete 160x550 mm. (299.903.03).
- Supporto per doccia (061.182.01).
- Doccetta anticalcare (034.116.01).
- Flessibile satin (91.34.609.15).

Concealed shower set

with water shut off and flow control.

- Built-in body included
- Stainless steel wall shower 160x550 mm. (299.903.03).
- Elbow wall (061.182.01).
- Antilime hand shower (034.116.01).
- Satin hose (91.34.609.15).

Podomítkový jednopákový sprchový set

s uzávěrem a regulací průtoku.

- Včetně podomítkového tělesa
- Nástěnné sprchové křepitko z nerez. oceli 160x550 mm (299.903.03).
- Držák s nástěnným přívodem vody (061.182.01).
- Ruční sprcha, proti usaz. vod. kamene (034.116.01).
- Flexi hadice SATIN (91.34.609.15).



91.30.190

Cr 062.516.01

596,00



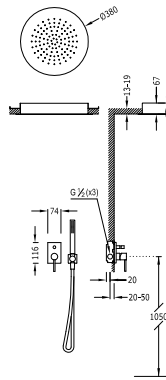

Kit doccia ad incasso

Con chiusura e regolazione di portata.

- Corpo incassato incluso
- Soffione doccia acciaio inossidabile Ø 380 mm. (1.34.940).
- Supporto per doccia (061.182.01).
- Doccetta anticalcare (034.116.01).
- Flessibile satin (91.34.609.15).

Concealed shower set

with water shut off and flow control.

- Built-in body included
- Steel shower head Ø 380 mm. (1.34.940).
- Elbow wall (061.182.01).
- Antilime hand shower (034.116.01).
- Satin hose (91.34.609.15).

Podomítkový jednopákový sprchový set

s uzávěrem a regulací průtoku.

- Včetně podomítkového tělesa
- Sprchové křepítko z nerez. oceli Ø 380 mm. (1.34.940).
- Držák s nástěnným přívodem vody (061.182.01).
- Ruční sprcha, proti usaz. vod. kamene (034.116.01).
- Flexi hadice SATIN (91.34.609.15).



91.30.190

Cr 062.180.09

897,00



BORDOVASCA / DECK-MOUNTED BATHTUBS / VANY S PRODLOUŽENÝM PULTEM

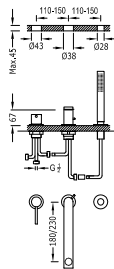

Monocomando bordo vasca

Doccetta anticalcare (034.116.01).

- Portata: 3 bar – 16 l/m.
- Compatibile con il kit serbatoio cod: 203.245.01.
- NOTA: vedere lunghezza canna.

Bath-shower single lever tap for bracket shelf

with shower antilime (034.116.01).

- Flowrate: 3 bar – 16 l/m.
- Compatible with tank kit ref: 203.245.01.
- NOTE: see pipe length

Jednopáková stojánková vanová baterie

Sprcha, proti usaz. vod. kamene (034.116.01).

- Průtok: 3 bar – 16 l/m
- Kompatibilní se sadou nádrže ref. č.: 203.245.01.
- POZNÁMKA: viz délka ramínka



91.34.591 (180 mm.)

Cr 062.161.03

347,00



91.34.591 (230 mm.)

Cr 062.161.02

358,00



Kit bordo vasca

Bath-shower kit cistern

Set nádrže pro stojánkové vanové baterie
(per ref. / for Nr. / Kód: 062.161.03, 062.161.02,
200.162.03, 200.162.01, 081.161.04, 081.161.03,
203.161.02, 203.161.01).

Cr 203.245.01 | 385,00



Valvola vasca con presa drenaggio

Bath valve with drainage point

Vanový odpadový ventil

Cr 1.34.445 | 86,75



TERMOSTATICHE / THERMOSTATICALLY-CONTROLLED / TERMOSTATICKÉ

Ref. / Nr. / Kód: Price

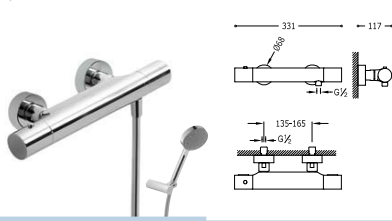

Doccia termostatica
(Doccetta anticalcare (299.748.02) con supporto orientabile.
Flessibile satin (91.34.609.15)).

Wall thermostatic shower mixer
(Anti-limescale hand shower (299.748.02) with directable support
and satin hose (91.34.609.15)).

Termostatická sprchová baterie
(Ruční sprcha (299.748.02) s nastavitelným držákem, proti usaz.
vod. kamene a flexi hadice (91.34.609.15))



299.195.03
Cr | 061.162.01 | 222,00

299.195.03
Cr | 061.162.09 | 270,00

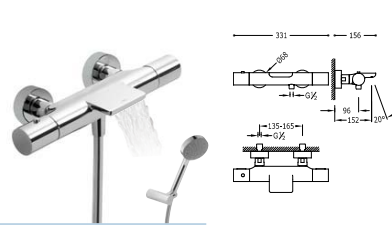

Vasca-Doccia termostatica
Con bocca a cascata (Doccetta anticalcare (299.748.02) con
supporto orientabile. Flessibile satin (91.34.609)).

Wall thermostatic shower mixer
With cascade (Anti-limescale hand shower (299.748.02) with
directable support and satin hose (91.34.609)).

Termostatická baterie pro vanu-sprchu
s vodopádem. (Ruční sprcha (299.748.02) s nastavitelným držákem,
proti usaz. vod. kamene a flexi hadice SATIN (91.34.609)).



299.195.03
Cr | 061.172.01 | 283,00

299.195.03
Cr | 061.172.09 | 332,00

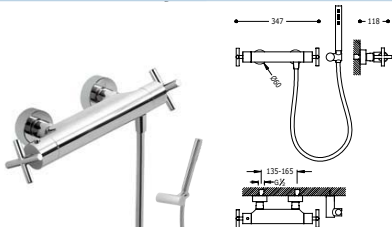

Doccia termostatica
(Doccetta anticalcare (034.116.01) con supporto orientabile.
Flessibile satin (91.34.609.15)).

Wall thermostatic shower mixer
(Anti-limescale hand shower (034.116.01) with directable support.
Shower hose satin (91.34.609.15)).

Termostatická sprchová baterie
s kaskádou. (Ruční sprcha s nastavitelným držákem (034.116.01), proti usaz. vod.
kamene a flexi hadice SATIN (91.34.609.15)).



299.163.01
Cr | 063.162.01 | 279,00

299.163.01
Cr | 063.162.09 | 334,00

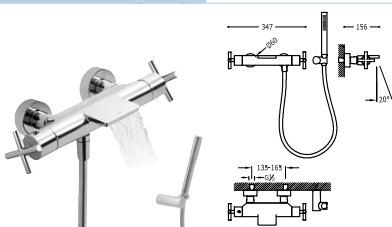

Vasca-Doccia termostatica
Con bocca a cascata (Doccetta anticalcare (034.116.01) con
supporto orientabile. Flessibile satin (91.34.609)).

Wall thermostatic shower mixer
With cascade (Anti-limescale hand shower (034.116.01) with
directable support. Shower hose satin (91.34.609)).

Termostatická baterie pro vanu-sprchu
s kaskádou. (Ruční sprcha s nastavitelným držákem (034.116.01),
proti usaz.vod. kamene a flexi hadice SATIN (91.34.609)).



299.163.01
Cr | 063.172.01 | 366,00

299.163.01
Cr | 063.172.09 | 420,00

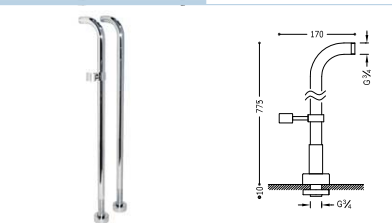

Prese d'acqua a terra per vasca da bagno
2 unità con supporto doccia girevole

Water intake at floor of bath
2 units with adjustable shower support

Vodovodní podlahové vanové přípojky
2 kusy s otočným sprchovým držákem

Cr | 1.61.194 | 275,00

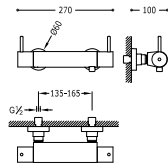

Doccia termostatica

Doccetta anticalcare (299.631.03) con supporto orientabile.
Flessibile satin (91.34.609.15). Indicato per persone con disabilità fisiche

Wall thermostatic shower mixer

Anti-limescale hand shower (299.631.03) with directable support.
Shower hose satin (91.34.609.15). Suitable for persons with physical disabilities.

Termostatická sprchová baterie

Ruční sprcha s nastavitelným držákem (299.631.03), proti usaz. vod. kamene a flexi hadice SATIN (91.34.609.15)). Určeno pro osoby s fyzickým handicapem



299.195.09
Cr **090.264.01** | **199,00**

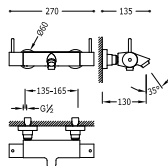

Vasca-Doccia termostatica

Doccetta anticalcare (299.631.03) con supporto orientabile.
Flessibile satin (91.34.609). Indicato per persone con disabilità fisiche

Wall thermostatic shower mixer

Anti-limescale hand shower (299.631.03) with directable support.
Shower hose satin (91.34.609). Suitable for persons with physical disabilities.

Termostatická baterie pro vanu-sprchu

Ruční sprcha s nastavitelným držákem (299.631.03), proti usaz. vod. kamene a flexi hadice SATIN (91.34.609)). Určeno pro osoby s fyzickým handicapem



299.195.09
Cr **090.274.01** | **252,00**



299.195.09
Cr **090.974.01** | **287,00**

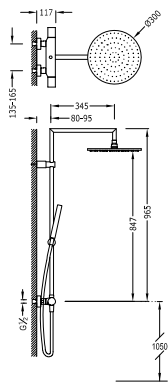

Set doccia termostatica

- Doccia fissa Ø 300 mm. con snodo. (1.34.137.30). Ottone.
- Doccetta anticalcare (034.116.01).
- Flessibile satin (91.34.609.15).
- Invertitore integrato nel regolatore di portata.

Wall thermostatic shower mixer

- Fixed shower head Ø 300 mm. with ball joint. (1.34.137.30). Brass.
- Antilime hand shower (034.116.01).
- Satin hose (91.34.609.15).
- Diverter integrated in the flow control.

Souprava termostatické sprchové baterie

- Pevná sprcha Ø 300 mm. s kloubem. (1.34.137.30). Materiál mosaz.
- Ruční sprcha, proti usaz. vod. kamene (034.116.01).
- Flexi hadice SATIN (91.34.609.15).
- Přepínač zabudovaný v regulaci průtoku.

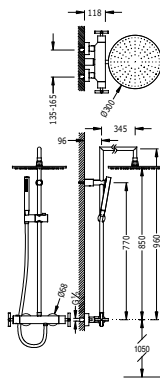

299.195.03
Cr **061.393.01** | **688,00**

**Set doccia termostatica**

- Doccia fissa Ø 300 mm. con snodo. (1.34.137.30). Ottone.
- Doccetta anticalcare (034.116.01).
- Flessibile satin (91.34.609.15).
- Invertitore integrato nel regolatore di portata.

Wall thermostatic shower mixer

- Fixed shower head Ø 300 mm. with ball joint. (1.34.137.30). Brass.
- Antilime hand shower (034.116.01).
- Satin hose (91.34.609.15).
- Diverter integrated in the flow control.

Souprava termostatické sprchové baterie

- Pevná sprcha Ø 300 mm. s kloubem. (1.34.137.30). Materiál mosaz.
- Ruční sprcha, proti usaz. vod. kamene (034.116.01).
- Flexi hadice SATIN (91.34.609.15).
- Přepínač zabudovaný v regulaci průtoku.



299.163.01

Cr 063.393.01

735,00

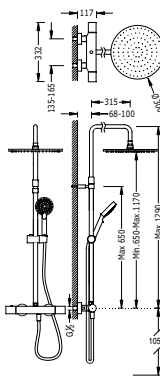
**Set doccia termostatica**

- Doccia fissa Ø 300 mm. con snodo. (1.34.137.30). Ottone.
- Doccetta anticalcare (299.748.02).
- Flessibile satin (91.34.609.15).
- Asta telescopica.
- Invertitore integrato nel regolatore di portata.

Wall thermostatic shower mixer

- Fixed shower head Ø 300 mm. with ball joint. (1.34.137.30). Brass.
- Antilime hand shower (299.748.02).
- Satin hose (91.34.609.15).
- Telescopic bar.
- Diverter integrated in the flow control.

Souprava termostatické sprchové baterie

- Pevná sprcha Ø 300 mm. s kloubem. (1.34.137.30). Materiál mosaz.
- Ruční sprcha, proti usaz. vod. kamene (299.748.02).
- Flexi hadice SATIN (91.34.609.15).
- Teleskopická tyč.
- Přepínač zabudovaný v regulaci průtoku.



299.195.03

Cr 061.210.01

728,00

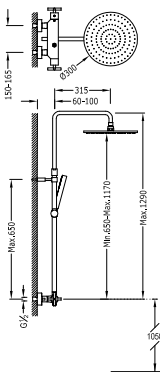
**Set doccia termostatica**

- Doccia fissa Ø 300 mm. con snodo. (1.34.137.30). Ottone.
- Doccetta anticalcare (034.116.01).
- Flessibile satin (91.34.609.15).
- Asta telescopica.
- Invertitore integrato nel regolatore di portata.

Wall thermostatic shower mixer

- Fixed shower head Ø 300 mm. with ball joint. (1.34.137.30). Brass.
- Antilime hand shower (034.116.01).
- Satin hose (91.34.609.15).
- Telescopic bar.
- Diverter integrated in the flow control.

Souprava termostatické sprchové baterie

- Pevná sprcha Ø 300 mm. s kloubem. (1.34.137.30). Materiál mosaz.
- Ruční sprcha, proti usaz. vod. kamene (034.116.01).
- Flexi hadice SATIN (91.34.609.15).
- Teleskopická tyč.
- Přepínač zabudovaný v regulaci průtoku.



299.163.01

Cr 063.211.01

775,00



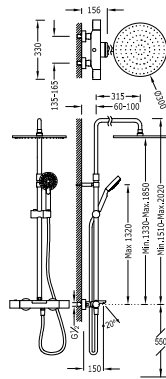

Vasca-Doccia termostatica

- Doccia fissa Ø 300 mm. con snodo. (1.34.137.30). Ottone.
- Doccetta anticalcare (299.748.02).
- Flessibile satin (91.34.609).
- Asta telescopica.

Wall thermostatic shower mixer

- Fixed shower head Ø 300 mm. with ball joint. (1.34.137.30). Brass.
- Antilime hand shower (299.748.02).
- Satin hose (91.34.609).
- Telescopic bar.

Souprava termostatické baterie pro vanu-sprchu

- Pevná sprcha Ø 300 mm. s kloubem. (1.34.137.30). Materiál mosaz.
- Ruční sprcha, proti usaz. vod. kamene (299.748.02).
- Flexí hadice SATIN (91.34.609).
- Teleskopická tyč.



299.195.03

Cr 062.312.01

810,00

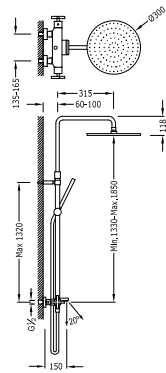

Vasca-Doccia termostatica

- Doccia fissa Ø 300 mm. con snodo. (1.34.137.30). Ottone.
- Doccetta anticalcare (034.116.01).
- Flessibile satin (91.34.609).
- Asta telescopica.

Wall thermostatic shower mixer

- Fixed shower head Ø 300 mm. with ball joint. (1.34.137.30). Brass.
- Antilime hand shower (034.116.01).
- Satin hose (91.34.609).
- Telescopic bar.

Souprava termostatické baterie pro vanu-sprchu

- Pevná sprcha Ø 300 mm. s kloubem. (1.34.137.30). Materiál mosaz.
- Ruční sprcha, proti usaz. vod. kamene (034.116.01).
- Flexí hadice SATIN (91.34.609).
- Teleskopická tyč.



299.312.02

Cr 063.312.01

810,00

RUBINETTI DI ARRESTO / SHUTOFF VALVES / PRŮCHOZÍ VENTILI

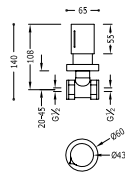

Rubinetto di arresto filettato 1/2"

1/2" threaded-ends gate-valve

Uzavírací ventil 1/2"

Cr 061.155.01

75,35

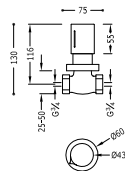

Rubinetto di arresto filettato 3/4"

3/4" threaded-ends gate-valve

Uzavírací ventil 3/4"

Cr 061.511.01

83,60



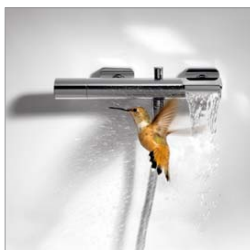

LOFT-TRES



Lavabi
Basin mixer taps
Koupelňová baterie
418



Bidet
Bidets
Bidety
422



Monocomando esterno
Bathtub mixer taps
Jednopákový mechanismus vany
424



Monocomando ad incasso
Built-in sets
Vestavné soupravy
424



Bordovasca
Deck-mounted bathtubs
Vany s prodlouženým pultem
426



Termostatica esterna
Thermostatically-controlled
Termostatické
426



Accessori
Accessories
Vybavení
348

www.tresgriferia.com



**RICAMBI SU
SPARE PARTS AT
NÁHRADNÍ DÍLY NA**
www.tresgriferia.com

LAVABI MONOCOMANDO / BASIN MIXER TAPS / KOUPELNOVÁ BATERIE

Ref. / Nr. / Kód:

Monocomando lavabo
con bocca a cascata. * NOTA: La rubinetteria con canna a cascata è
accompagnata da 2 rubinetti di regolazione con filtro (Ref: 91.34.525)

Single lever washbasin mixer
with cascade cast spout. * NOTE: Taps with a cascade spout come with
2 regulation valves and a filter (Nr.: 91.34.525)

Jednopáková umyvadlová baterie
ramínko s vodopádem. * POZNÁMKA: Baterie typu vodopádu je
doplňena dvěma regulačními kohouty s filtrem (Kód: 91.34.525)

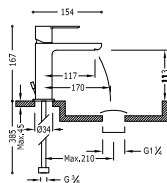
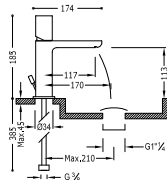

Monocomando lavabo
con bocca a cascata aperta. NOTA: La rubinetteria con canna a cascata è
accompagnata da 2 rubinetti di regolazione con filtro (Ref: 91.34.525)

Single lever washbasin mixer
with open cascade spout. NOTE: Taps with a cascade spout come with
2 regulation valves and a filter (Nr: 91.34.525)

Jednopáková umyvadlová baterie
ramínko s otevřeným vodopádem. POZNÁMKA: Baterie typu vodopádu
je doplňena dvěma regulačními kohouty s filtrem (Kód: 91.34.525)

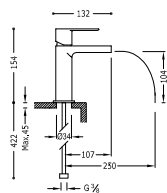
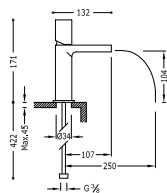

Monocomando lavabo

con bocca a cascata. * NOTA: La rubinetteria con canna a cascata è accompagnata da 2 rubinetti di regolazione con filtro (Ref: 91.34.525)

Single lever washbasin mixer

with cascade cast spout. * NOTE: Taps with a cascade spout come with 2 regulation valves and a filter (Nr.: 91.34.525)

Jednopáková umyvadlová baterie

ramínko s vodopádem. * POZNÁMKA: Baterie typu vodopádu je doplněna dvěma regulačními kohouty s filtrem (Kód: 91.34.525)

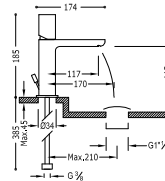
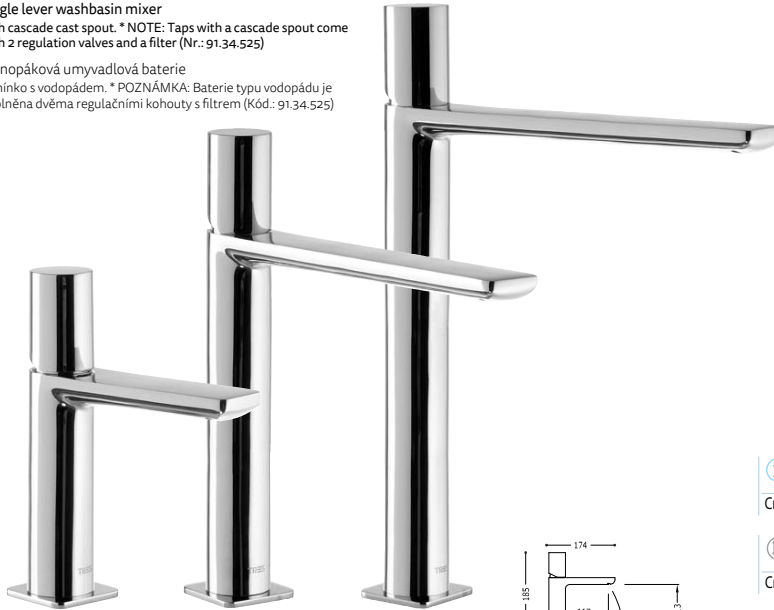

Cr | **200.103.02**



Cr | **200.103.02.D**

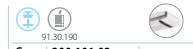

Cr | **200.101.02**



Cr | **200.101.02.D**

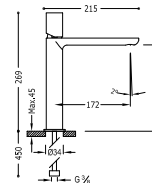

Cr | **200.203.04**

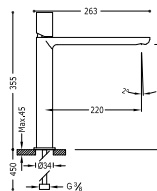

Cr | **200.203.06**

Monocomando lavabo
con bocca a cascata. * NOTA: La rubinetteria con canna a cascata è
accompagnata da 2 rubinetti di regolazione con filtro (Ref: 91.34.525)

Single lever washbasin mixer
with cascade cast spout. * NOTE: Taps with a cascade spout come
with 2 regulation valves and a filter (Nr.: 91.34.525)

Jednopáková umyvadlová baterie
ramínko s vodopádem. * POZNÁMKA: Baterie typu vodopádu je
doplňena dvěma regulačními kohouty s filtrem (Kód.: 91.34.525)

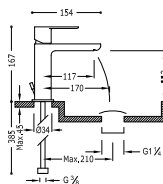
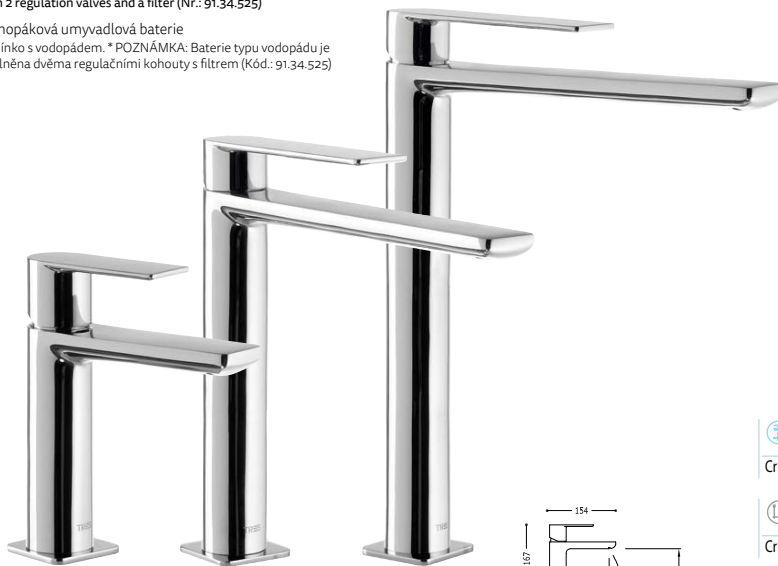

Cr 200.103.01



Cr 200.103.01.D



Cr 200.101.01



Cr 200.101.01.D

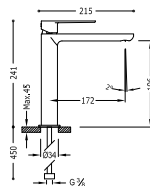

Cr 200.203.03

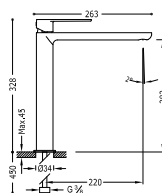

Cr 200.203.05

Monocomando lavabo
Single lever washbasin mixer
Jednöpáková umyvadlová baterie

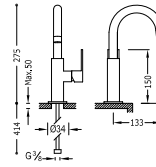

Cr 200.205.04

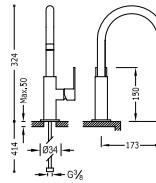

Cr 200.205.05

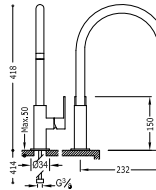

Cr 200.205.06



Monocomando lavabo
cana 35x15 mm.
Single lever washbasin mixer
spout 35x15 mm.
Jednöpáková umyvadlová baterie
ramínko 35x15 mm

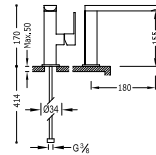

Cr 200.205.01

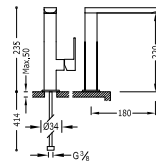

Cr 200.205.02

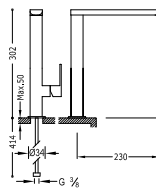

Cr 200.205.03



MONOCOMANDI BAGNO / BATHTUB MIXER TAPS / JEDNOPÁKOVÝ MECHANISMUS VANY

Ref. / Nr. / Kód:

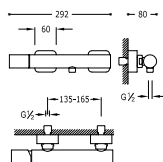

Monocomando doccia

Doccetta anticalcare (034.639.01) con supporto orientabile.
Flessibile satin (91.34.609.15).

Single lever shower mixer

Anti-limescale hand shower (034.639.01) with directable support.
Shower hose satin (91.34.609.15).

Jednopaková sprchová baterie

Ruční sprcha (034.639.01) s nastavitelným držákem, proti usaz. vod. kamene a flexi hadice SATIN (91.34.609.15).

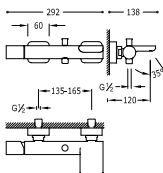
91.30.190
Cr 200.167.01

Monocomando vasca

Con bocca a cascata. Doccetta anticalcare (034.639.01) con supporto orientabile. Flessibile satin (91.34.609).

Single lever bath and shower mixer

with cascade. Anti-limescale hand shower (034.639.01) with directable support. Shower hose satin (91.34.609).

Jednopaková baterie pro vanu-sprchu

s kaskádou. Ruční sprcha (034.639.01) s nastavitelným držákem, proti usaz. vod. kamene a flexi hadice SATIN (91.34.609)

91.30.190
Cr 200.170.01

GRUPPI AD INCASSO / BUILT-IN SETS / VESTAVĚNÉ SOUPRAVY

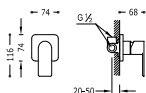
Monocomando incasso (1 via)
corpo incassato incluso

Built-in mixer taps (1 way)

Built-in body included

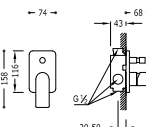
Vestavěná jednopaková baterie (jednocestný)
včetně podomítkového tělesa91.30.190
Cr 200.177.01Monocomando incasso (2 vie)
corpo incassato incluso

Built-in mixer taps (2 way)

Built-in body included

Vestavěná jednopaková baterie (dvoucestný)
včetně podomítkového tělesa91.30.190
Cr 200.180.01

Prolunga per monocomando incasso bagno-doccia

Extension for built-in bathtub-shower mixer tap

Nástavec pro vestavěnou jednopakovou vanu/sprchu

91.07.190.05
Cr 200.180.10

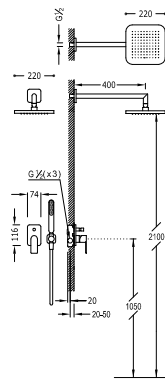

Kit doccia ad incasso

- Con chiusura e regolazione di portata.
 - Corpo incassato incluso
 - Doccia fissa 220x220 mm. con snodo. (299.632.06).
 - Supporto per doccia (200.182.01).
 - Doccetta anticalcare (034.639.01).
 - Flessibile satin (91.34.609.15).

Concealed shower set

- with water shut off and flow control.
 - Built-in body included
 - Fixed shower head 220x220 mm. with ball joint. (299.632.06).
 - Elbow wall (200.182.01).
 - Antilime hand shower (034.639.01).
 - Satin hose (91.34.609.15).

Podomítkový jednopákový sprchový set

- s uzávěrem a regulací průtoku.
 - Včetně podomítkového tělesa
 - Pevná sprcha 220x220 mm. s kloubem. (299.632.06).
 - Držák s nástěnným přívodem vody (200.182.01).
 - Ruční sprcha, proti usaz. vod. Kamene (034.639.01).
 - Flexi hadice SATIN (91.34.609.15).



91.30.190

Cr 200.180.02

N

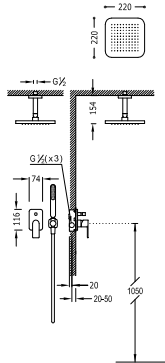

Kit doccia ad incasso

- Con chiusura e regolazione di portata.
 - Corpo incassato incluso
 - Doccia fissa 220x220 mm. con snodo. (299.632.06).
 - Supporto per doccia (200.182.01).
 - Doccetta anticalcare (034.639.01).
 - Flessibile satin (91.34.609.15).

Concealed shower set

- with water shut off and flow control.
 - Built-in body included
 - Fixed shower head 220x220 mm. with ball joint. (299.632.06).
 - Elbow wall (200.182.01).
 - Antilime hand shower (034.639.01).
 - Satin hose (91.34.609.15).

Podomítkový jednopákový sprchový set

- s uzávěrem a regulací průtoku.
 - Včetně podomítkového tělesa
 - Pevná sprcha 220x220 mm. s kloubem. (299.632.06).
 - Držák s nástěnným přívodem vody (200.182.01).
 - Ruční sprcha, proti usaz. vod. Kamene (034.639.01).
 - Flexi hadice SATIN (91.34.609.15).



91.30.190

Cr 200.180.80

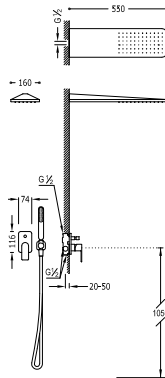

Kit doccia ad incasso

- Con chiusura e regolazione di portata.
 - Corpo incassato incluso
 - Doccia acciaio inossidabile da parete 160x550 mm. (299.903.06).
 - Supporto per doccia (200.182.01).
 - Doccetta anticalcare (034.639.01).
 - Flessibile satin (91.34.609.15).

Concealed shower set

- with water shut off and flow control.
 - Built-in body included
 - Stainless steel wall shower 160x550 mm. (299.903.06).
 - Elbow wall (200.182.01).
 - Antilime hand shower (034.639.01).
 - Satin hose (91.34.609.15).

Podomítkový jednopákový sprchový set

- s uzávěrem a regulací průtoku.
 - Včetně podomítkového tělesa
 - Nástěnné sprchové křepitko z nerez. oceli 160x550 mm. (299.903.06).
 - Držák s nástěnným přívodem vody (200.182.01).
 - Ruční sprcha, proti usaz. vod. Kamene (034.639.01).
 - Flexi hadice SATIN (91.34.609.15).



91.30.190

Cr 200.180.05

BORDOVASCA / DECK-MOUNTED BATHTUBS / VANY S PRODLOUŽENÝM PULTEM

Ref. / Nr. / Kód:

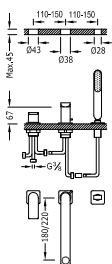

Monocomando bordo vasca
con doccetta anticalcare (034.639.01).
· Portata: 3 bar – 16 l/m.
· Compatible con il kit serbatoio cod: 203.245.01.
· NOTA: vedere lunghezza canna.

Bath-shower single lever tap for bracket shelf
with shower antilime (034.639.01).
· Flowrate: 3 bar – 16 l/m.
· Compatible with tank kit ref: 203.245.01.
· NOTE: see pipe length

Jednopáková stojánková vanová baterie
Sprcha, proti usaz. vod. kamene (034.639.01).
· Průtok: 3 bar – 16 l/m
· Kompatibilní se sadou nádrže ref. č.: 203.245.01.
· POZNÁMKA: viz délka ramínka

91.34.591 (180 mm.)
Cr 200.162.03

91.34.591 (220 mm.)
Cr 200.162.01



Kit bordo vasca
Bath-shower kit cistern
Set nádrže pro stojánkové vanové baterie
(per ref. / for Nr. / Kód: 062.161.03, 062.161.02,
200.162.03, 200.162.01, 081.161.04, 081.161.03,
203.161.02, 203.161.01).

Cr 203.245.01 290



Valvola vasca con presa drenaggio
Bath valve with drainage point
Vanový odpadový ventil

Cr 1.34.445 290

TERMOSTATICHE / THERMOSTATICALLY-CONTROLLED / TERMOSTATICKÉ

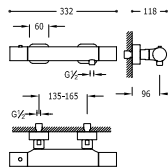

Doccia termostatica
(Doccetta anticalcare (034.639.01) con supporto orientabile.
Flessibile satin (91.34.609.15)).

Wall thermostatic shower mixer
(Anti-limescale hand shower (034.639.01) with directable support.
Shower hose satin (91.34.609.15)).

Termostatická sprchová baterie
(Ruční sprcha (034.639.01) s nastavitelným držákem, proti usaz.
vod. kamene a flexi hadice SATIN (91.34.609.15))



299.195.03
Cr 200.164.01

299.195.03
Cr 200.164.09

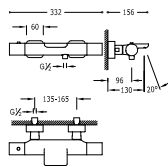

Bagno doccia termostatica
Con bocca a cascata (Doccetta anticalcare (034.639.01) con
supporto orientabile. Flessibile satin (91.34.609)).

Wall thermostatic bath and shower mixer
with cascade (Anti-limescale hand shower (034.639.01) with
directable support. Shower hose satin (91.34.609)).

Termostatická baterie pro vanu-sprchu
s kaskádou (Ruční sprcha (034.639.01) s nastavitelným držákem,
proti usaz. vod. kamene a flexi hadice SATIN (91.34.609)).



299.195.03
Cr 200.174.01

299.195.03
Cr 200.174.09

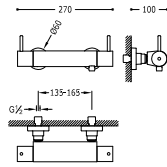

Doccia termostatica

Doccetta anticalcare (299.631.03) con supporto orientabile.
Flessibile satin (91.34.609.15). Indicato per persone con disabilità fisiche

Wall thermostatic shower mixer

Anti-limescale hand shower (299.631.03) with directable support.
Shower hose satin (91.34.609.15). Suitable for persons with physical disabilities.

Termostatická sprchová baterie

Ruční sprcha s nastavitelným držákem (299.631.03), proti usaz. vod. kamene a flexi hadice SATIN (91.34.609.15)). Určeno pro osoby s fyzickým handicapem



299.195.09

Cr | **090.264.01**

299.195.09

Cr | **090.964.01**

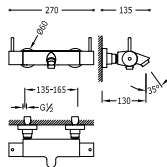

Vasca-Doccia termostatica

Doccetta anticalcare (299.631.03) con supporto orientabile.
Flessibile satin (91.34.609). Indicato per persone con disabilità fisiche.

Wall thermostatic shower mixer

Anti-limescale hand shower (299.631.03) with directable support.
Shower hose satin (91.34.609). Suitable for persons with physical disabilities.

Termostatická baterie pro vanu-sprchu

Ruční sprcha s nastavitelným držákem (299.631.03), proti usaz. vod. kamene a flexi hadice SATIN (91.34.609.15)). Určeno pro osoby s fyzickým handicapem



299.195.09

Cr | **090.274.01**

299.195.09

Cr | **090.974.01**

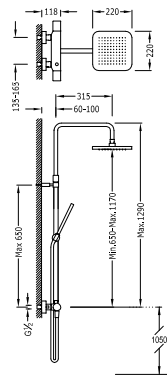

Set doccia termostatica

- Doccia fissa 220x220 mm. con snodo. (299.632.06).
- Doccetta anticalcare (034.639.01).
- Flessibile satin (91.34.609.15).
- Asta telescopica.
- Invertitore integrato nel regolatore di portata.

Wall thermostatic shower mixer

- Fixed shower head 220x220 mm. with ball joint. (299.632.06).
- Antilime hand shower (034.639.01).
- Satin hose (91.34.609.15).
- Telescopic bar.
- Diverter integrated in the flow control.

Souprava termostatické sprchové baterie

- Pevná sprcha 220x220 mm. s kloubem. (299.632.06).
- Ruční sprcha, proti usaz. vod. kamene (034.639.01).
- Flexi hadice SATIN (91.34.609.15).
- Teleskopická tyč.
- Přepínač zabudovaný v regulaci průtoku.



299.195.03

Cr | **200.195.01**

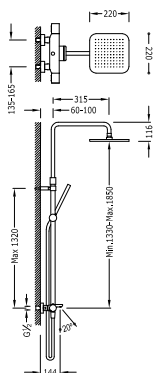

Vasca-Doccia termostatica

- Doccia fissa 220x220 mm. con snodo. (299.632.06).
- Doccetta anticalcare (034.639.01).
- Flessibile satin (91.34.609).
- Asta telescopica.

Wall thermostatic shower mixer

- Fixed shower head 220x220 mm. with ball joint. (299.632.06).
- Antilime hand shower (034.639.01).
- Satin hose (91.34.609).
- Telescopic bar.

Souprava termostatické baterie pro vanu-sprchu

- Pevná sprcha 220x220 mm. s kloubem. (299.632.06).
- Ruční sprcha, proti usaz. vod. kamene (034.639.01).
- Flexi hadice SATIN (91.34.609).
- Teleskopická tyč.



299.195.03

Cr 200.312.01

RUBINETTI DI ARRESTO / SHUTOFF VALVES / PRŮCHOZÍ VENTILY

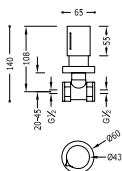

Rubinetto di arresto filettato 1/2"

1/2" threaded-ends gate-valve

Uzavírací ventil 1/2"

Cr 061.155.01

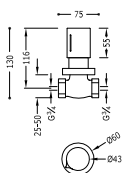

Rubinetto di arresto filettato 3/4"

3/4" threaded-ends gate-valve

Uzavírací ventil 3/4"

Cr 061.511.01





CLASS-TRES



Lavabi
Basin mixer taps
Koupelňová baterie
432



Bideti
Bidets
Bidety
436



Monocomando esterno
Bathtub mixer taps
Jednopákový mechanismus vany
437



Monocomando ad incasso
Built-in sets
Vestavné soupravy
438



Bordovasca
Deck-mounted bathtubs
Vany s prodlouženým pultem
439



Termostatica esterna
Thermostatically-controlled
Termostatické
440



Accessori
Accessories
Vybavení
346

www.tresgriferia.com



RICAMBI SU
SPARE PARTS AT
NÁHRADNÍ DÍLY NA
www.tresgriferia.com

Monocomando lavabo
canna 34x9 mm.

Single lever washbasin mixer
spout 34x9 mm.

Jednopáková umyvadlová baterie
ramínko 34x9 mm.

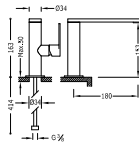

360° 91.30.190

Cr 205.205.01

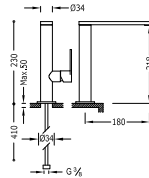

360° 91.30.190

Cr 205.205.02

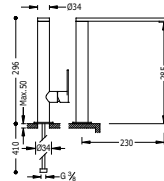

360° 91.30.190

Cr 205.205.03

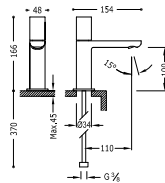

Rubinetto lavandino 1 acqua o premiscelata

1 water or premixed bathroom tap

Umyvadlová baterie pro jednu nebo předem smíchanou vodu



91.34.282

Cr 200.503.01

Lavabo temporizzato 1 acqua
Chiusura automatica a 6 sec.

Single water temperature timer sink tap
Automatic shut-off at 6 seconds

Umyvadlová baterie pro jednu vodu s časovým vypínačem
Automatické uzavření po uplynutí 6 s

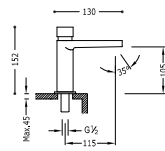

299.396.01 6"

Cr 205.112.01



Lavabo temporizzato miscelatore

Chiusura automatica a 6 sec. NOTA: include un rubinetto miscelatore a due acque con tubi flessibili (per ref.: 1.92.507.30).

Mixer timer sink tap

Automatic shut-off at 6 seconds. NOTE: Includes a hot and cold mixer tap with flexible pipes (for Nr.: 1.92.507.30).

Směšovací umyvadlová baterie

Automatické uzavření po uplynutí 6 s. POZNÁMKA: Obsahuje směšovací baterii pro teplou i studenou vodu s ohebnými hadicemi (Kód: 1.92.507.30).

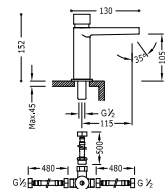

299.396.01 6"

Cr 205.112.02



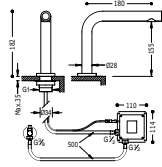

Lavabo elettronico 1 acqua TOUCH-TRES
Sistema sensibile al tatto. Senza premere.

TOUCH-TRES 1 water electronic tap
Sensitive system to the touch. No press.

Elektronická baterie na 1 vodu TOUCH-TRES
Dotyková. Pouze na dotek (NESMÍ se stisknout)



Cr **061.447.01**

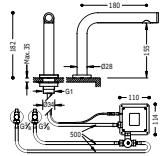

Lavabo elettronico miscelatore TOUCH-TRES
Sistema sensibile al tatto. Senza premere. NOTA: include un rubinetto miscelatore a due acque con tubi flessibili (per ref.: 1.92.507.30).

TOUCH-TRES electronic mixer tap
Sensitive system to the touch. No press. NOTE: Includes a hot and cold mixer tap with flexible pipes (for Nr.: 1.92.507.30).

Směšovací elektronická baterie TOUCH-TRES
Dotyková. Pouze na dotek (NESMÍ se stisknout). POZNÁMKA: Obsahuje směšnou baterii pro teplou i studenou vodu s ohebnými hadicemi (Kód: 1.92.507.30).



Cr **061.448.01**

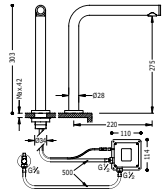

Lavabo elettronico 1 acqua TOUCH-TRES
Sistema sensibile al tatto. Senza premere.

TOUCH-TRES 1 water electronic tap
Sensitive system to the touch. No press.

Elektronická baterie na 1 vodu TOUCH-TRES
Dotyková. Pouze na dotek (NESMÍ se stisknout)



Cr **1.61.445**

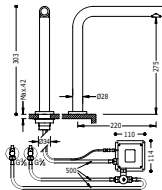

Lavabo elettronico miscelatore TOUCH-TRES
Sistema sensibile al tatto. Senza premere. NOTA: include un rubinetto miscelatore a due acque con tubi flessibili (per ref.: 1.92.507.30).

TOUCH-TRES electronic mixer tap
Sensitive system to the touch. No press. NOTE: Includes a hot and cold mixer tap with flexible pipes (for Nr.: 1.92.507.30).

Elektronická baterie směsná TOUCH-TRES
Dotyková. Pouze na dotek (NESMÍ se stisknout). POZNÁMKA: Obsahuje směšnou baterii pro teplou i studenou vodu s ohebnými hadicemi (Kód: 1.92.507.30).

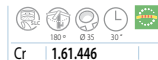

Cr **1.61.446**

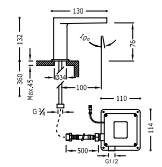

Lavabo elettronico 1 acqua TOUCH-TRES
Azionamento tramite sensore a infrarossi

1 water electronic tap
Operated by an infrared sensor

Elektronická baterie na 1 vodu
Spouštěna snímačem infračerveného záření



Cr **205.603.01**

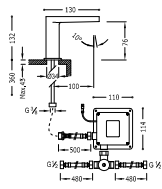

Lavabo elettronico miscelatore TOUCH-TRES
Azionamento tramite sensore a infrarossi. NOTA: include un rubinetto miscelatore a due acque con tubi flessibili (per ref.: 1.92.507.30).

Electronic mixer tap
Operated by an infrared sensor. NOTE: Includes a hot and cold mixer tap with flexible pipes (for Nr.: 1.92.507.30).

Směšovací elektronická baterie
Spuštěna snímačem infračerveného záření. POZNÁMKA: Obsahuje směšnou baterii pro teplou i studenou vodu s ohebnými hadicemi (Kód: 1.92.507.30).



Cr **205.603.02**

Monomando a muro
Single lever wall washbasin mixer
Jednopáková nástěnná baterie



91.30.190 (160 mm.)
Cr 205.200.70

91.30.190 (210 mm.)
Cr 205.200.71

91.30.190 (250 mm.)
Cr 205.200.02

Monomando a muro
Single lever wall washbasin mixer
Jednopáková nástěnná baterie

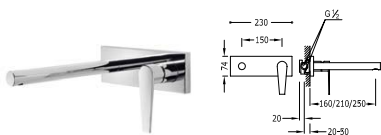

91.30.190 (160 mm.)
Cr 205.200.40

91.30.190 (210 mm.)
Cr 205.200.41

91.30.190 (250 mm.)
Cr 205.200.01

BIDET / BIDETS / BIDETY

Monocomando bidet
Single lever bidet mixer
Jednopáková bidetová baterie

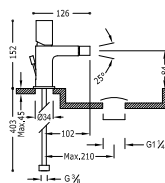

91.30.190
Cr 205.120.02

91.30.190
Cr 205.120.02.D

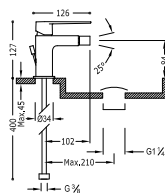

91.30.190
Cr 205.120.01

91.30.190
Cr 205.120.01.D

Monocomando bidet con doccia
Bidet mixer tap with small shower head
Jednopáková bidetová baterie se sprškou



91.34.592
Cr 200.130.01

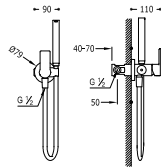

Monocomando ad incasso per bidé WC

Supporto a destra o a sinistra, intercambiabile. Flesso satinato.*
Opzione Cartongesso

Concealed single lever bidet/toilets

Left or right support, interchangeable. Sateen hose.* Optie gips

Jednopáková podomítková baterie pro bidet WC

Vyměnitelný držák zprava či zleva. Sprchová mosazná baterie s omezovacím hrdlem 5 l/m. Systém proti kapání a flexi hadice SATIN.*
* Možnost pro sádkartonové panely

91.34.591	
Cr	205.223.01
Cr	205.222.01*



Accessori portasciugamani

180 mm. (per ref.: 1.34.122, 1.34.123, 1.81.122, 1.81.123, 205.222.01, 205.223.01). NOTA: Supporto a destra o a sinistra, intercambiabile.

Accessory towel racks

180 mm. (for Nr.: 1.34.122, 1.34.123, 1.81.122, 1.81.123, 205.222.01, 205.223.01). NOTE: Left or right support, interchangeable.

Průslušenství držák na ručníky

180 mm. (Kód: 1.34.122, 1.34.123, 1.81.122, 1.81.123, 205.222.01, 205.223.01). POZNÁMKA: Právý nebo levý podstavec, vyměnitelný.

Cr	034.124.01
----	------------

MONOCOMANDI BAGNO / BATH/ TUB MIXER TAPS / JEDNOPÁKOVÝ MECHANISMUS VANY

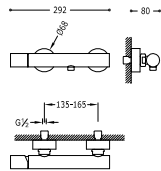

Monocomando doccia

Doccetta anticalcare (299.631.08) con supporto orientabile.
Flessibile satin (91.34.609.15).

Single lever shower mixer

Anti-limescale hand shower (299.631.08) with directable support.
Shower hose satin (91.34.609.15).

Jednopáková sprchová baterie

Ruční sprcha (299.631.08) s nastavitelným držákem, proti usaz. vod. kamene a flexi hadice SATIN (91.34.609.15).

91.34.190	91.34.609
Cr	205.168.01

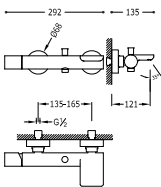

Monocomando vasca

Con bocca a cascata. Doccetta anticalcare (299.631.08) con supporto orientabile. Flessibile satin (91.34.609).

Single lever bath and shower mixer

with cascade. Anti-limescale hand shower (299.631.08) with directable support. Shower hose satin (91.34.609).

Vanová baterie

s kaskádou. Ruční sprcha (299.631.08) s nastavitelným držákem, proti usaz. vod. kamene a flexi hadice SATIN (91.34.609)

91.30.190	
Cr	205.474.01

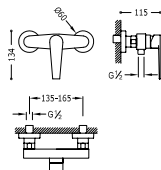

Monocomando doccia

Doccetta anticalcare (299.631.08) con supporto orientabile.
Flessibile satin (91.34.609.15).

Single lever shower mixer

Anti-limescale hand shower (299.631.08) with directable support.
Shower hose satin (91.34.609.15).

Jednopáková sprchová baterie

Ruční sprcha (299.631.08) s nastavitelným držákem, proti usaz. vod. kamene a flexi hadice SATIN (91.34.609.15).

91.07.190.05	91.34.609
Cr	205.167.01

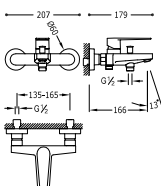

Monocomando vasca

Doccetta anticalcare (299.631.08) con supporto orientabile.
Flessibile satin (91.34.609).

Single lever bath and shower mixer

Anti-limescale hand shower (299.631.08) with directable support.
Shower hose satin (91.34.609).

Vanová baterie

Ruční sprcha (299.631.08) s nastavitelným držákem, proti usaz. vod. kamene a flexi hadice SATIN (91.34.609)

91.30.190	
Cr	205.170.01

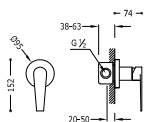

Monocomando incasso (1 via)
corpo incassato incluso

Built-in mixer taps (1 way)
Built-in body included

Vestavěná jednopáková baterie (jednocestná)
včetně podomítkového tělesa

91.30.190
Cr 205.177.01

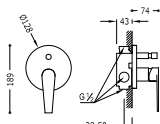

Monocomando incasso (2 vie)
corpo incassato incluso

Built-in mixer taps (2 way)
Built-in body included

Vestavěná jednopáková baterie (dvoucestná)
včetně podomítkového tělesa

91.30.190
Cr 205.180.01

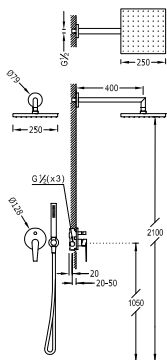

Kit doccia ad incasso

Con chiusura e regolazione di portata.
Corpo incassato incluso
- Doccia fissa 250x250 mm. con snodo. (1.34.138.26).
- Supporto per doccia (205.182.01).
- Doccetta anticalcare (299.631.08).
- Flessibile satin (91.34.609.15).

Concealed shower set

with water shut off and flow control.
- Built-in body included
- Fixed shower head 250x250 mm. with ball joint. (1.34.138.26).
- Elbow wall (205.182.01).
- Antilime hand shower (299.631.08).
- Satin hose (91.34.609.15).

Podomítkový jednopákový sprchový set

s uzávěrem a regulací průtoku.
- Včetně podomítkového tělesa
- Pevná sprcha 250x250 mm. s kloubem. (1.34.138.26).
- Držák s nástěnným přívodem vody (205.182.01).
- Ruční sprcha, proti usaz. vod. kamene (299.631.08).
- Flexi hadice SATIN (91.34.609.15).

91.30.190
Cr 205.180.02

N

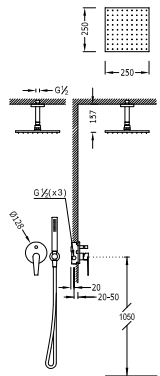

Kit doccia ad incasso

Con chiusura e regolazione di portata.
Corpo incassato incluso
- Doccia fissa 250x250 mm. con snodo. (1.34.138.26).
- Supporto per doccia (205.182.01).
- Doccetta anticalcare (299.631.08).
- Flessibile satin (91.34.609.15).

Concealed shower set

with water shut off and flow control.
- Built-in body included
- Fixed shower head 250x250 mm. with ball joint. (1.34.138.26).
- Elbow wall (205.182.01).
- Antilime hand shower (299.631.08).
- Satin hose (91.34.609.15).

Podomítkový jednopákový sprchový set

s uzávěrem a regulací průtoku.
- Včetně podomítkového tělesa
- Pevná sprcha 250x250 mm. s kloubem. (1.34.138.26).
- Držák s nástěnným přívodem vody (205.182.01).
- Ruční sprcha, proti usaz. vod. kamene (299.631.08).
- Flexi hadice SATIN (91.34.609.15).

91.30.190
Cr 205.180.00

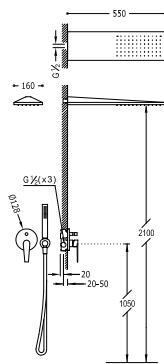

Kit doccia ad incasso

Con chiusura e regolazione di portata.

- Corpo incassato incluso
- Doccia acciaio inossidabile da parete 160x550 mm. (299.903.03)
- Supporto per doccia (205.182.01)
- Doccetta anticalcare (299.631.08)
- Flessibile satin (91.34.609.15)

Concealed shower set

with water shut off and flow control.

- Built-in body included
- Stainless steel wall shower 160x550 mm. (299.903.03)
- Elbow wall (205.182.01)
- Antilime hand shower (299.631.08)
- Satin hose (91.34.609.15)

Podomítkový jednopákový sprchový set

s uzávěrem a regulací průtoku.

- Včetně podomítkového tělesa
- Nástěnné sprchové křepitko z nerez. oceli 160x550 mm (299.903.03)
- Držák s nástěnným přívodem vody (91.06.182)
- Ruční sprcha, proti usaz. vod. kamene (299.631.08)
- Flexi hadice SATIN (91.34.609.15)



Cr 205.180.03

BORDOVASCA / DECK-MOUNTED BATHTUBS / VANY S PRODLOUŽENÝM PULTEM

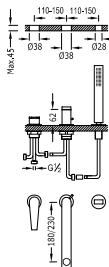

Monocomando bordo vasca

con doccetta anticalcare (299.631.08).

- Portata: 3 bar – 13 l/m.
- Compatibile con il kit serbatoio cod: 200.245.01.
- NOTA: vedere lunghezza canna.

Bath-shower single lever tap for bracket shelf

with shower antilime (299.631.08).

- Flowrate: 3 bar – 13 l/m.
- Compatible with tank kit ref: 200.245.01.
- NOTE: see pipe length

Jednopáková stojánková vanová baterie

Sprcha, proti usaz. vod. kamene (299.631.08).

- Průtok: 3 bar – 13 l/m
- Kompatibilní se sadou nádrže ref. č.: 200.245.01.
- POZNÁMKA: viz délka ramínka



91.30.190 (180 mm)

Cr 205.161.03



91.30.190 (230 mm)

Cr 205.161.01



Kit bordo vasca

Bath-shower kit cistern

Set nádrže pro stojánkové vanové baterie
(per ref. / for Nr. / Kód: 006.161.06, 006.161.04,
006.161.05, 006.161.03, 205.161.03, 205.161.01).

Cr 200.245.01



Valvola vasca con presa drenaggio

Bath valve with drainage point

Vanový odpadový ventil

Cr 1.34.445



TERMOSTATICHE / THERMOSTATICALLY-CONTROLLED / TERMOSTATICKÉ

Ref. / Nr. / Kód:

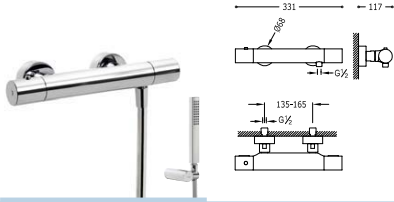

Doccia termostatica
 (Doccetta anticalcare (299.631.08) con supporto orientabile.
 Flessibile satin (91.34.609.15)).

Wall thermostatic shower mixer
 (Anti-limescale hand shower (299.631.08) with directable support.
 Shower hose satin (91.34.609.15)).

Termostatická sprchová baterie
 (Ruční sprcha s nastavitelným držákem (299.631.08), proti usaz.
 vod. kamene a flexi hadice SATIN (91.34.609.15)).



299.195.03
Cr 061.162.01

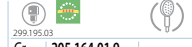

299.195.03
Cr 205.164.019

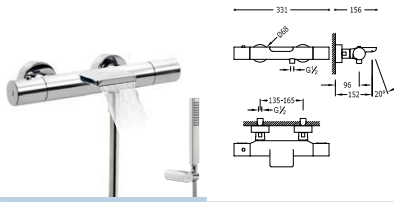

Vasca-Doccia termostatica
 Con bocca a cascata (Doccetta anticalcare (299.631.08) con
 supporto orientabile. Flessibile satin (91.34.609)).

Wall thermostatic bath and shower mixer
 with cascade (Anti-limescale hand shower (299.631.08) with
 directable support. Shower hose satin (91.34.609)).

Termostatická baterie pro vanu-sprchu
 s kaskádou. (Ruční sprcha s nastavitelným držákem (299.631.08),
 proti usaz. vod. kamene a flexi hadice SATIN (91.34.609)).



299.195.03
Cr 061.172.01



299.195.03
Cr 205.174.019

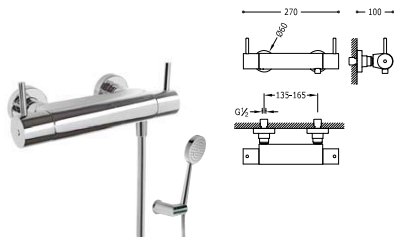

Doccia termostatica
 Doccetta anticalcare (299.631.03) con supporto orientabile.
 Flessibile satin (91.34.609.15). Indicato per persone con disabilità
 fisiche

Wall thermostatic shower mixer
 Anti-limescale hand shower (299.631.03) with directable support.
 Shower hose satin (91.34.609.15). Suitable for persons with
 physical disabilities.

Termostatická sprchová baterie
 Ruční sprcha s nastavitelným držákem (299.631.03), proti usaz. vod.
 kamene a flexi hadice SATIN (91.34.609.15). Určeno pro osoby s
 fyzickým handicapem



299.195.09
Cr 090.264.01



299.195.09
Cr 090.964.01

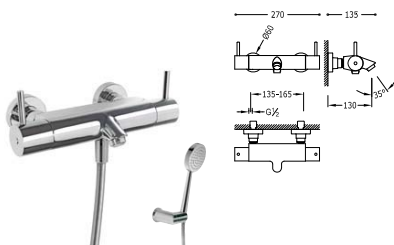

Vasca-Doccia termostatica
 Doccetta anticalcare (299.631.03) con supporto orientabile.
 Flessibile satin (91.34.609). Indicato per persone con disabilità
 fisiche.

Wall thermostatic shower mixer
 Anti-limescale hand shower (299.631.03) with directable support.
 Shower hose satin (91.34.609). Suitable for persons with physical
 disabilities.

Termostatická baterie pro vanu-sprchu
 Ruční sprcha s nastavitelným držákem (299.631.03), proti usaz.
 vod. kamene a flexi hadice SATIN (91.34.609). Určeno pro osoby s
 fyzickým handicapem



299.195.09
Cr 090.274.01



299.195.09
Cr 090.974.01

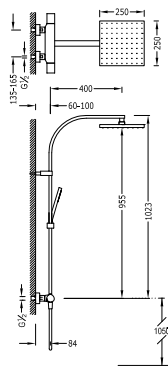

Set doccia termostatica

- Doccia fissa 250x250 mm. con snodo. (1.34.138.26).
- Doccetta anticalcare (299.631.08).
- Flessibile satin (91.34.609.15).
- Invertitore integrato nel regolatore di portata.

Wall thermostatic shower mixer

- Fixed shower head 250x250 mm. with ball joint. (1.34.138.26).
- Antilime hand shower (299.631.08)
- Satin hose (91.34.609.15).
- Diverter integrated in the flow control.

Souprava termostatické sprchové baterie

- Pevná sprcha 250x250 mm. s kloubem. (1.34.138.26).
- Ruční sprcha, proti usaz. vod. kamene (299.631.08).
- Flexi hadice SATIN (91.34.609.15).
- Přepínač zabudovaný v regulaci průtoku.



299.195.03
Cr **205.395.01**

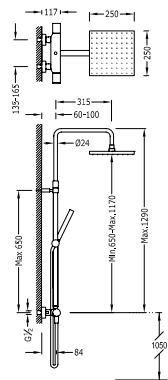

Set doccia termostatica

- Doccia fissa 250x250 mm. con snodo. (1.34.138.26).
- Doccetta anticalcare (299.631.08).
- Flessibile satin (91.34.609.15).
- Asta telescopica.
- Invertitore integrato nel regolatore di portata.

Wall thermostatic shower mixer

- Fixed shower head 250x250 mm. with ball joint. (1.34.138.26).
- Antilime hand shower (299.631.08).
- Satin hose (91.34.609.15).
- Telescopic bar.
- Diverter integrated in the flow control.

Souprava termostatické sprchové baterie

- Pevná sprcha 250x250 mm. s kloubem. (1.34.138.26).
- Ruční sprcha, proti usaz. vod. kamene (299.631.08).
- Flexi hadice SATIN (91.34.609.15).
- Teleskopická tyč.
- Přepínač zabudovaný v regulaci průtoku.



299.195.03
Cr **205.385.01**

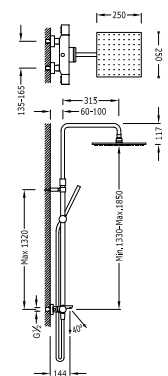

Vasca-Doccia termostatica

- Doccia fissa 250x250 mm. con snodo. (1.34.138.26).
- Doccetta anticalcare (299.631.08).
- Flessibile satin (91.34.609.15).
- Asta telescopica.

Wall thermostatic shower mixer

- Fixed shower head 250x250 mm. with ball joint. (1.34.138.26).
- Antilime hand shower (299.631.08).
- Satin hose (91.34.609.15).
- Telescopic bar.

Souprava termostatické baterie pro vanu-sprchu

- Pevná sprcha 250x250 mm. s kloubem. (1.34.138.26).
- Ruční sprcha, proti usaz. vod. kamene (299.631.08).
- Flexi hadice SATIN (91.34.609.15).
- Teleskopická tyč.



299.195.03
Cr **205.312.01**





LEX-TRES



Lavabi
Basin mixer taps
Koupelňová baterie
444



Bidet
Bidets
Bidety
447



Monocomando esterno
Bathtub mixer taps
Jednopákový mechanismus vany
449



Monocomando ad incasso
Built-in sets
Vestavné soupravy
451



Bordovasca
Deck-mounted bathtubs
Vany s prodlouženým pultem
452



Termostatica esterna
Thermostatically-controlled
Termostatické
453



Termostatica ad incasso
Concealed thermostatic mixer
Podomítková termostatická baterie
455



Accessori
Accessories
Vybavení
343

www.tresgriferia.com



**RICAMBI SU
SPARE PARTS AT
NÁHRADNÍ DÍLY NA**
www.tresgriferia.com

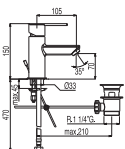

Monocomando lavabo
Single lever washbasin mixer
Jednopáková umyvadlová baterie



Cr | 1.81.103



Cr | 1.86.103

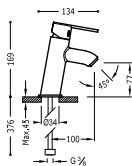

Monocomando lavabo
Single lever washbasin mixer
Jednopáková umyvadlová baterie



Cr | 1.81.903



Cr | 1.86.903



Monocomando lavabo
con prolunga inferiore

Single lever washbasin mixer
with base extension

Jednopávková umyvadlová baterie
s nástavcem

MISURE SPECIALI / EXCEPTIONAL MEASURES / NESTANDARDNÍ ROZMERY

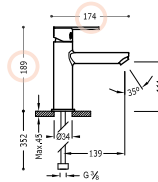

91.34.592

Cr | **1.81.203** |



91.34.592

Cr | **1.86.203** |

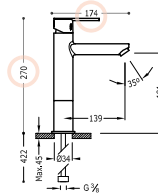

91.34.592

Cr | **1.81.217** |



91.34.592

Cr | **1.86.217** |

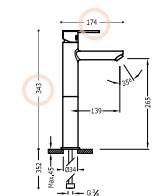

91.34.592

Cr | **1.81.207** |



91.34.592

Cr | **1.86.207** |

Monocomando lavabo
Single lever washbasin mixer
Jednopáková umyvadlová baterie

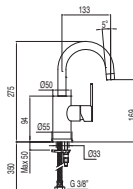

Cr 1.81.703

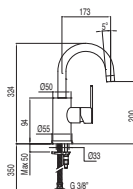

Cr 1.81.403

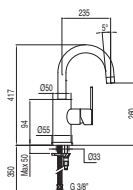

Cr 1.81.303

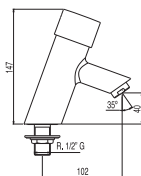

Lavabo temporizzato 1 acqua
Chiusura automatica a 6 sec. Flusso 6,5 l/min.

Single water temperature timer sink tap
Automatic shut-off at 6 seconds. Flow 6.5 l/min.

Umyvadlová baterie pro jednu vodu s časovým vypínačem
Automatické uzavření po uplynutí 6 s. Průtok 6,5 l/min.



Cr 1.12.203

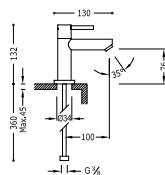

Rubinetto lavandino 1 acqua o premiscelata
1 water or premixed bathroom tap

Umyvadlová baterie pro jednu nebo předem smíchanou vodu

Cr 1.62.503

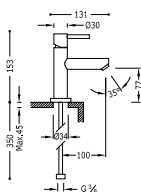

Monocomando lavabo Ø 30 mm.
Single lever washbasin mixer Ø 30 mm.
Jednopáková umyvadlová baterie Ø 30 mm

Cr 1.62.603

Monomando a muro
Single lever wall washbasin mixer
Jednopáková nástěnná baterie

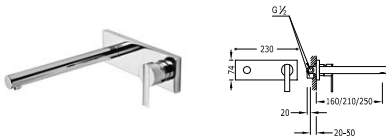

91.34.592 (160 mm.)
Cr | **081.200.01**

91.34.592 (210 mm.)
Cr | **081.200.21**

91.34.592 (250 mm.)
Cr | **1.81.200**



Monomando a muro
con bocca a cascata
Single lever wall washbasin mixer
with cascade cast spout
Jednopáková nástěnná baterie
ramínko s kaskádou



91.34.592.10
Cr | **081.260.10**

BIDET / BIDEIS / BIDEY

Monocomando bidet
Single lever bidet mixer
Jednopáková bidetová baterie

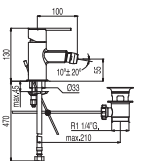

91.34.592
Cr | **1.81.120**

91.34.592
Cr | **1.86.120**

Monocomando bidet
Single lever bidet mixer
Jednopáková bidetová baterie

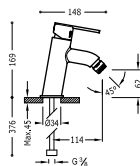

91.34.592
Cr | **1.81.920**

91.34.592
Cr | **1.86.920**

Monocomando bidet
Single lever bidet mixer
Jednopáková bidetová baterie

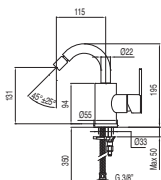

360° 91.34.592
Cr | **1.81.224**



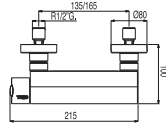

Monocomando doccia

Doccetta massaggi Ø 100 mm. (5 funzioni) (1.34.748) con supporto orientabile e flessibile satin (91.34.609.15).

Single lever shower mixer

Massage hand shower Ø 100 mm. (5 functions) (1.34.748) with directable support and satin hose (91.34.609.15).

Jednopáková sprchová baterie

Ruční masážní sprcha Ø 100 mm. (5 funkcí) (1.34.748) s nastavitelným držákem. Flexi hadice SATIN (91.34.609.15).



Cr 1.81.468

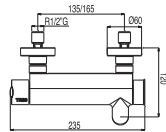

Monocomando vasca

Doccetta massaggi Ø 100 mm. (5 funzioni) (1.34.748) con supporto orientabile e flessibile satin (91.34.609).

Single lever bath and shower mixer

Massage hand shower Ø 100 mm. (5 fonctions) (1.34.748) with directable support and satin hose (91.34.609).

Jednopáková baterie pro vanu-sprchu

Ruční masážní sprcha Ø 100 mm. (5 funkcí) (1.34.748) s nastavitelným držákem. Flexi hadice SATIN (91.34.609).



Cr 1.81.474

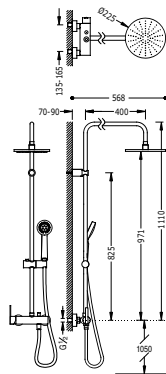

Set doccia

- Doccetta fissa Ø 225 mm. con snodo. (299.632.01).
- Doccetta Ø 100 mm. (5 funzioni) (1.34.748).
- Flessibile satin (91.34.609.15).

Bar-shower set

- Fixed shower head Ø 225 mm. with ball joint. (299.632.01).
- Massage hand shower Ø 100 mm. (5 fonctions) (1.34.748).
- Satin hose (91.34.609.15).

Sprchová souprava, proti usaz. vod. kamene

- Pevná sprcha Ø 225 mm. s kloubem. (299.632.01).
- Ruční masážní sprcha Ø 100 mm. (5 funkcí) (1.34.748).
- Flexi hadice SATIN (91.34.609.15).



Cr 1.81.191

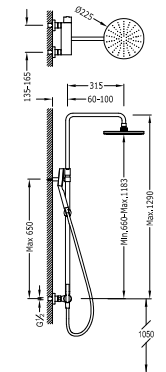

Set doccia

- Doccetta fissa Ø 225 mm. con snodo. (299.632.01).
- Doccetta Ø 100 mm. (5 funzioni) (1.34.748).
- Flessibile satin (91.34.609.15).
- Asta telescopica.

Bar-shower set

- Fixed shower head Ø 225 mm. with ball joint. (299.632.01).
- Massage hand shower Ø 100 mm. (5 fonctions) (1.34.748).
- Satin hose (91.34.609.15).
- Telescopic bar.

Sprchová souprava, proti usaz. vod. kamene

- Pevná sprcha Ø 225 mm. s kloubem. (299.632.01).
- Ruční masážní sprcha Ø 100 mm. (5 funkcí) (1.34.748).
- Flexi hadice SATIN (91.34.609.15).
- Teleskopická tyč.

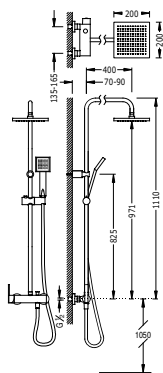

Cr 081.197.02

**Set doccia**

- Doccia fissa 200x200 mm. con snodo. (299.632.11).
- Doccetta anticalcare (1.34.612).
- Flessibile satin (91.34.609.15).

Bar-shower set

- Fixed shower head 200x200 mm. with ball joint. (299.632.11).
- Antilime hand shower (1.34.612).
- Satin hose (91.34.609.15).

Sprchová souprava, proti usaz. vod. kamene

- Pevná sprcha 200x200 mm. s kloubem. (299.632.11).
- Ruční sprcha, proti usaz. vod. kamene (1.34.612).
- Flexi hadice SATIN (91.34.609.15).



91.34.592

Cr 081.193.01

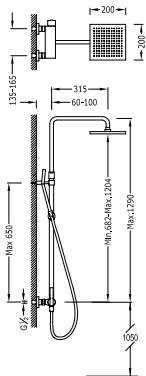
**Set doccia**

- Doccia fissa 200x200 mm. con snodo. (299.632.11).
- Doccetta anticalcare (1.34.612).
- Flessibile satin (91.34.609.15).
- Asta telescopica.

Bar-shower set

- Fixed shower head 200x200 mm. with ball joint. (299.632.11).
- Antilime hand shower (1.34.612).
- Satin hose (91.34.609.15).
- Telescopic bar.

Sprchová souprava, proti usaz. vod. kamene

- Pevná sprcha 200x200 mm. s kloubem. (299.632.11).
- Ruční sprcha, proti usaz. vod. kamene (1.34.612).
- Flexi hadice SATIN (91.34.609.15).
- Teleskopická tyč.



91.34.592

Cr 081.197.01

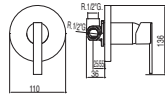

Monocomando incasso (1 vie)
corpo incassato incluso

Built-in mixer taps (1 way)
Built-in body included

Vestavěná jednopáková baterie (jednocestný)
včetně podomítkového tělesa



91.34.592

Cr | **1.81.177.05**

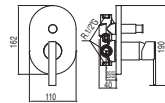

Monocomando incasso (2 vie)
corpo incassato incluso

Built-in mixer taps (2 way)
Built-in body included

Vestavěná jednopáková baterie (dvoucestný)
včetně podomítkového tělesa



91.34.592

Cr | **1.81.180.05**

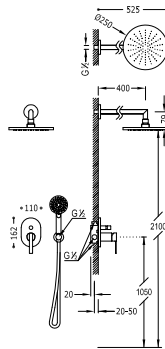

Kit doccia ad incasso

Con chiusura e regolazione di portata.

Corpo incassato incluso

· Doccia fissa Ø 250 mm. con snodo. (1.34.137.26).

· Supporto per doccia (205.182.01).

· Doccetta Ø 100 mm. (5 funzioni) (1.34.748).

· Flessibile satin (91.34.609.15).

Concealed shower set

with water shut off and flow control.

· Built-in body included

· Fixed shower head Ø 250 mm. with ball joint. (1.34.137.26).

· Elbow wall (205.182.01).

· Massage hand shower Ø 100 mm. (5 fonctions) (1.34.748).

· Satin hose (91.34.609.15).

Podomítkový sprchový set baterie

s uzávěrem a regulací průtoku.

· Včetně podomítkového tělesa

· Pevná sprcha Ø 250 mm. s kloubem. (1.34.137.26).

· Držák s nástěnným přívodem vody (205.182.01).

· Ruční masážní sprcha Ø 100 mm (5 funkcí) (1.34.748).

· Flexi hadice SATIN (91.34.609.15).



91.34.592

Cr | **1.81.880.05**

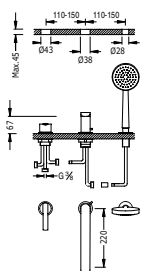

Monocomando bordo vasca
 Doccetta massaggi Ø 100 mm. (5 funzioni) (1.34.748).
 · Portata: 3 bar – 16 l/m.
 · Compatibile con il kit serbatoio cod: 203.245.01.
 · NOTA: vedere lunghezza canna.

Bath-shower single lever tap for bracket shelf
 Massage hand shower Ø 100 mm. (5 functions) (1.34.748).
 · Flowrate: 3 bar – 16 l/m.
 · Compatible with tank kit ref: 203.245.01.
 · NOTE: see pipe length

Jednopáková stojánková vanová baterie
 Ruční masážní sprcha Ø 100 mm. (5 funkcí) (1.34.748).
 · Průtok: 3 bar – 16 l/m.
 · Kompatibilní se sadou nádrže ref. č.: 203.245.01.
 · POZNÁMKA: viz délka ramínka

91.34.591
 (180 mm.)
 Cr | 081.161.04

91.34.591
 (220 mm.)
 Cr | 081.161.03



Kit bordo vasca
 Bath-shower kit cistern
 Set nádrže pro stojánkové vanové baterie
 (per ref. / for Nr. / Kód: 062.161.03, 062.161.02,
 200.162.03, 200.162.01, 081.161.04, 081.161.03,
 203.161.02, 203.161.01).

Cr | 203.245.01

📄 290



Valvola vasca con presa drenaggio
 Bath valve with drainage point
 Vanový odpadový ventil

Cr | 1.34.445

📄 290

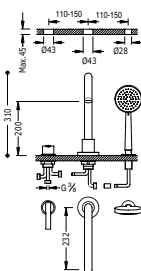

Monocomando bordo vasca
 Doccetta massaggi Ø 100 mm. (5 funzioni) (1.34.748).
 · Portata: 3 bar – 14 l/m.
 · Compatibile con il kit serbatoio cod: 1.89.245.

Bath-shower single lever tap for bracket shelf
 Massage hand shower Ø 100 mm. (5 functions) (1.34.748).
 · Flowrate: 3 bar – 14 l/m.
 · Compatible with tank kit ref: 1.89.245.

Jednopáková vanová stojánková baterie
 Ruční masážní sprcha Ø 100 mm. (5 funkcí) (1.34.748).
 · Průtok: 3 bar – 14 l/m.
 · Kompatibilní se sadou nádrže ref. č.: 1.89.245.

91.34.591
 Cr | 081.150.01



Kit bordo vasca
 Bath-shower kit cistern
 Set nádrže pro stojánkové vanové baterie
 (per ref. / for Nr. / Kód: 081.150.01).

Cr | 1.89.245

📄 290



Valvola vasca con presa drenaggio
 Bath valve with drainage point
 Vanový odpadový ventil

Cr | 1.34.445

📄 290

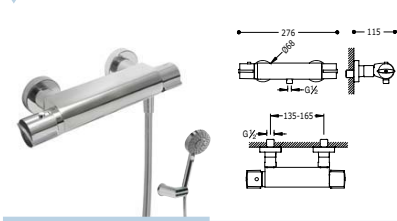

Doccia termostatica
(Doccetta Ø 100 mm. (5 funzioni) (1.34.748) con supporto orientabile e flessibile satin (91.34.609.15)).

Wall thermostatic shower mixer
(Massage hand shower Ø 100 mm. (5 fonctions) (1.34.748) with directable support and satin hose (91.34.609.15)).

Termostatická sprchová baterie
(Ruční masážní sprcha Ø 100 mm. (5 funkcí) (1.34.748) s nastavitelným držákem. Flexi hadice SATIN (91.34.609.15)).



Cr **1.81.164**



Cr **1.81.164.9**

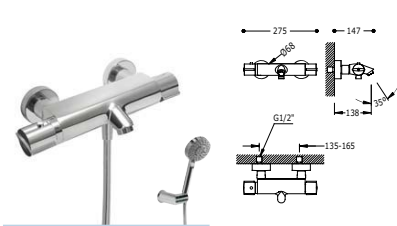

Vasca-Doccia termostatica
(Doccetta Ø 100 mm. (5 funzioni) (1.34.748) con supporto orientabile e flessibile satin (91.34.609)).

Badthermostaat
(Massage hand shower Ø 100 mm. (5 fonctions) (1.34.748) with directable support and satin hose (91.34.609)).

Termostatická baterie pro vanu-sprchu
(Ruční masážní sprcha Ø 100 mm. (5 funkcí) (1.34.748) s nastavitelným držákem. Flexi hadice SATIN (91.34.609)).



Cr **1.81.174**



Cr **1.81.174.9**

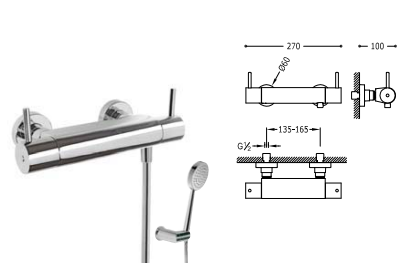

Doccia termostatica
Doccetta anticalcare (299.631.03) con supporto orientabile. Flessibile satin (91.34.609.15). Indicato per persone con disabilità fisiche

Wall thermostatic shower mixer
Anti-limescale hand shower (299.631.03) with directable support. Shower hose satin (91.34.609.15). Suitable for persons with physical disabilities.

Termostatická sprchová baterie
Ruční sprcha s nastavitelným držákem (299.631.03), proti usaz. vod. kamene a flexi hadice SATIN (91.34.609.15). Určeno pro osoby s fyzickým handicapem



Cr **090.264.01**



Cr **090.964.01**

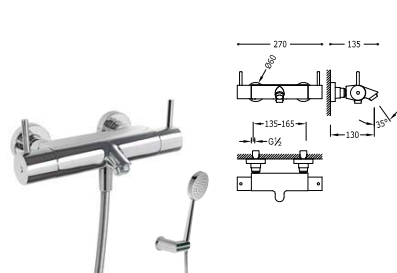

Vasca-Doccia termostatica
Doccetta anticalcare (299.631.03) con supporto orientabile. Flessibile satin (91.34.609). Indicato per persone con disabilità fisiche.

Wall thermostatic shower mixer
Anti-limescale hand shower (299.631.03) with directable support. Shower hose satin (91.34.609). Suitable for persons with physical disabilities.

Termostatická baterie pro vanu-sprchu
Ruční sprcha s nastavitelným držákem (299.631.03), proti usaz. vod. kamene a flexi hadice SATIN (91.34.609). Určeno pro osoby s fyzickým handicapem



Cr **090.274.01**



Cr **090.974.01**

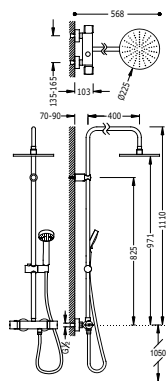

Set doccia termostatica

- Doccia fissa Ø 225 mm. con snodo. (299.632.01).
- Doccetta massaggio Ø 100 mm. (5 funzioni) (1.34.748).
- Tubo flessibile satin (91.34.609.15).
- Invertitore integrato nel regolatore di portata.

Wall thermostatic shower mixer

- Fixed shower head Ø 225 mm. with ball joint. (299.632.01).
- Massage hand shower Ø 100 mm. (5 functions) (1.34.748).
- Satin hose (91.34.609.15).
- Diverter integrated in the flow control.

Souprava termostatické sprchové baterie

- Pevná sprcha Ø 225 mm. s kloubem. (299.632.01).
- Ruční masážní sprcha Ø 100 mm. (5 funkcí) (1.34.748).
- Flexi hadice SATIN (91.34.609.15).
- Přepínač zabudovaný v regulaci průtoku.

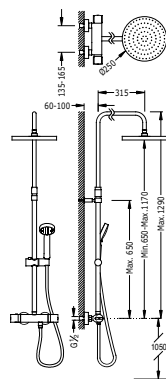

Set doccia termostatica

- Doccia fissa Ø 250 mm. con snodo. (1.34.137.26).
- Doccetta massaggio Ø 100 mm. (5 funzioni) (1.34.748).
- Flessibile satin (91.34.609.15).
- Asta telescopica.
- Invertitore integrato nel regolatore di portata.

Wall thermostatic shower mixer

- Fixed shower head Ø 250 mm. with ball joint. (1.34.137.26).
- Massage hand shower Ø 100 mm. (5 functions) (1.34.748).
- Satin hose (91.34.609.15).
- Telescopic bar.
- Diverter integrated in the flow control.

Souprava termostatické sprchové baterie

- Pevná sprcha Ø 250 mm. s kloubem. (1.34.137.26).
- Ruční masážní sprcha Ø 100 mm. (5 funkcí) (1.34.748).
- Flexi hadice SATIN (91.34.609.15).
- Teleskopická tyč.
- Přepínač zabudovaný v regulaci průtoku.

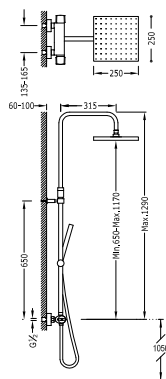

Set doccia termostatica

- Doccia fissa 250x250 mm. con snodo. (1.34.138.26).
- Doccetta anticalcare (006.639.01).
- Flessibile satin (91.34.609.15).
- Asta telescopica.
- Invertitore integrato nel regolatore di portata.

Wall thermostatic shower mixer

- Fixed shower head 250x250 mm. with ball joint. (1.34.138.26).
- Antilime hand shower (006.639.01).
- Satin hose (91.34.609.15).
- Telescopic bar.
- Diverter integrated in the flow control.

Souprava termostatické sprchové baterie

- Pevná sprcha 250x250 mm. s kloubem. (1.34.138.26).
- Ruční sprcha, proti usaz. vod. kamene (006.639.01).
- Flexi hadice SATIN (91.34.609.15).
- Teleskopická tyč.
- Přepínač zabudovaný v regulaci průtoku.



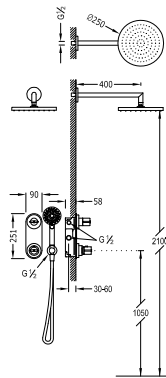

Kit doccia termostatica ad incasso

Con chiusura e regolazione di portata (2 vie).

- Corpo incassato termostatico incluso
- Doccia fissa Ø 250 mm. con snodo. (1.34.137.26)
- Supporto per doccia (205.182.01)
- Doccetta massaggio Ø 100 mm. (5 funzioni) (1.34.748)
- Tubo flessibile satin (91.34.609.15)

Concealed thermostatic shower kit

with water shut off and flow control (2 ways).

- Built-in thermostatic body included
- Fixed shower head Ø 250 mm. with ball joint. (1.34.137.26)
- Elbow wall (205.182.01)
- Massage hand shower Ø 100 mm. (5 fonctions) (1.34.748)
- Satin hose (91.34.609.15)

Podomítkový termostatický sprchový set

s uzávěrem a regulací průtoku (2-cestná).

- Včetně podomítkového termostatického tělesa
- Pevná sprcha Ø 250 mm. s kloubem. (1.34.137.26)
- Držák s nástěnným přívodem vody (205.182.01)
- Ruční masážní sprcha Ø 100 mm (5 funkcí) (1.34.748)
- Flexi hadice SATIN (91.34.609.15)



29925055

Cr 1.81.175







ALPLUS



Lavabi
Basin mixer taps
Koupelňová baterie
458



Bidet
Bidets
Bidety
461



Monocomando esterno
Bathtub mixer taps
Jednopákový mechanismus vany
463



Monocomando ad incasso
Built-in sets
Vestavné soupravy
464



Bordovasca
Deck-mounted bathtubs
Vany s prodlouženým pultem
465



Termostatica esterna
Thermostatically-controlled
Termostatické
465



Termostatica ad incasso
Concealed thermostatic mixer
Podomítková termostatická baterie
467



Accessori
Accessories
Vybavení
343

www.tresgriferia.com



**RICAMBI SU
SPARE PARTS AT
NÁHRADNÍ DÍLY NA**
www.tresgriferia.com

Monocomando lavabo
con prolunga inferiore

Single lever washbasin mixer
with base extension

Jednopáková umyvadlová baterie
s nástavcem

MISURE SPECIALI / EXCEPTIONAL MEASURES / NESTANDARDNÍ ROZMERY

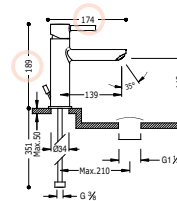

Cr | 203.203.01



Cr | 203.203.01.D

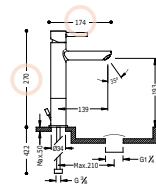

Cr | 203.217.01



Cr | 203.217.01.D

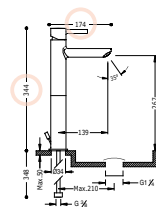

Cr | 203.207.01



Cr | 203.207.01.D

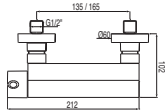

Monocomando doccia
Doccetta anticalcare (299.631.03) con supporto orientabile.
Flessibile satin (91.34.609.15).

Single lever shower mixer
Anti-limescale hand shower (299.631.03) with directable support.
Shower hose satin (91.34.609.15).

Jednopaková sprchová baterie
Ruční sprcha s nastavitelným držákem (299.631.03), proti usaz. vod.
kamene a flexi hadice SATIN (91.34.609.15).

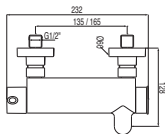

Monocomando vasca
Doccetta anticalcare (299.631.03) con supporto orientabile.
Flessibile satin (91.34.609).

Single lever bath and shower mixer
Anti-limescale hand shower (299.631.03) with directable support.
Shower hose satin (91.34.609).

Jednopaková baterie pro vanu-sprchu
Ruční sprcha s nastavitelným držákem (299.631.03), proti usaz. vod.
kamene a flexi hadice SATIN (91.34.609).

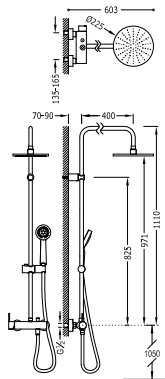

Set doccia
· Doccia fissa Ø 225 mm. con snodo. (299.632.01).
· Doccetta anticalcare (299.631.03).
· Flessibile satin (91.34.609.15).

Bar-shower set
· Fixed shower head Ø 225 mm. with ball joint. (299.632.01).
· Antilime hand shower (299.631.03).
· Satin hose (91.34.609.15).

Sprchová souprava, proti usaz. vod. kamene
· Pevná sprcha Ø 225 mm. s kloubem. (299.632.01).
· Ruční sprcha, proti usaz. vod. kamene (299.631.03)
· Flexi hadice SATIN (91.34.609.15).



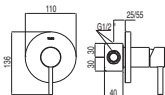

Monocomando incasso (1 via)
corpo incassato incluso

Built-in mixer taps (1 way)
Built-in body included

Vestavěná jednopáková baterie (jednocestná)
včetně podomítkového tělesa



91.34.592

Cr | 203.177.01

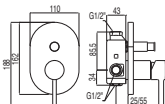

Monocomando incasso (2 vie)
corpo incassato incluso

Built-in mixer taps (2 way)
Built-in body included

Vestavěná jednopáková baterie (dvoucestná)
včetně podomítkového tělesa



91.34.592

Cr | 203.180.01

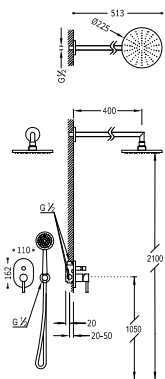

Kit doccia ad incasso

con chiusura e regolazione di portata.

Corpo incassato incluso

- Doccia fissa Ø 225 mm. con snodo. (299.632.01).

- Supporto per doccia (205.182.01).

- Doccetta anticalcare (299.631.03).

- Flessibile satin (91.34.609.15).

Concealed shower set

with water shut off and flow control.

- Built-in body included

- Fixed shower head Ø 225 mm. with ball joint. (299.632.01).

- Elbow wall (205.182.01).

- Antilime hand shower (299.631.03).

- Satin hose (91.34.609.15).

Sprchový podomítkový set

s uzávěrem a regulací průtoku.

- Včetně podomítkového tělesa

- Pevná sprcha Ø 225 mm. s kloubem. (299.632.01).

- Držák s nástěnným přívodem vody (205.182.01).

- Ruční sprcha, proti usaz. vod. kamene (299.631.03).

- Flexi hadice SATIN (91.34.609.15).



91.34.592

Cr | 203.180.02

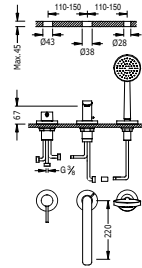

Monocomando bordo vasca
Doccetta anticalcare (299.631.03).
- Portata: 3 bar – 16 l/m.
- Compatibile con il kit serbatoio cod: 203.245.01.
- NOTA: vedere lunghezza canna.

Bath-shower single lever tap for bracket shelf

Antilime hand shower (299.631.03).
- Flowrate: 3 bar – 16 l/m.
- Compatible with tank kit ref: 203.245.01.
- NOTE: see pipe length

Jednopáková stojánková vanová baterie

Sprcha, proti usaz. vod. kamene (299.631.03).
- Průtok: 3 bar – 16 l/m
- Kompatibilní se sadou nádrže ref. č.: 203.245.01.
- POZNÁMKA: viz délka ramínka

91.34.591 (180 mm.)
Cr 203.161.02

91.34.591 (220 mm.)
Cr 203.161.01



Kit bordo vasca
Bath-shower kit cistern
Set nádrže pro stojánkové vanové baterie
(per ref. / for Nr. / Kód: 062.161.03, 062.161.02,
200.162.03, 200.162.01, 081.161.04, 081.161.03,
203.161.02, 203.161.01).

Cr 203.245.01



290



Valvola vasca con presa drenaggio
Bath valve with drainage point
Vanový odpadový ventil

Cr 1.34.445



290

TERMOSTATICHE / THERMOSTATICALLY-CONTROLLED / TERMOSTATICKÉ

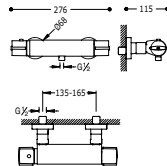

Doccia termostatica
(Doccetta Ø 100 mm. (5 funzioni) (1.34.748) con supporto orientabile e flessibile satin (91.34.609.15)).

Wall thermostatic shower mixer
(Massage hand shower Ø 100 mm. (5 fonctions) (1.34.748) with directable support and satin hose (91.34.609.15)).

Termostatická sprchová baterie
(Ruční masážní sprcha Ø 100 mm. (5 funkcí) (1.34.748) s nastavitelným držákem. Flexi hadice SATIN (91.34.609.15)).



91.81.161.10 IA IB
Cr 1.81.164

91.81.161.10 IA IB
Cr 1.81.164.9

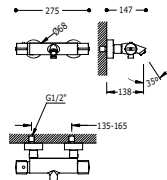

Vasca-Doccia termostatica
(Doccetta Ø 100 mm. (5 funzioni) (1.34.748) con supporto orientabile e flessibile satin (91.34.609.15)).

Badthermostaat
(Massage hand shower Ø 100 mm. (5 fonctions) (1.34.748) with directable support and satin hose (91.34.609.15)).

Termostatická baterie pro vanu-sprchu
(Ruční masážní sprcha Ø 100 mm. (5 funkcí) (1.34.748) s nastavitelným držákem. Flexi hadice SATIN (91.34.609.15)).



91.81.161.10
Cr 1.81.174

91.81.161.10
Cr 1.81.174.9

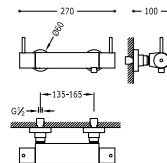

Doccia termostatica
Doccetta anticalcare (299.631.03) con supporto orientabile. Flessibile satin (91.34.609.15). Indicato per persone con disabilità fisiche.

Wall thermostatic shower mixer
Anti-limescale hand shower (299.631.03) with directable support. Shower hose satin (91.34.609.15). Suitable for persons with physical disabilities.

Termostatická sprchová baterie
Ruční sprcha s nastavitelným držákem (299.631.03), proti usaz. vod. kamene a flexi hadice SATIN (91.34.609.15). Určeno pro osoby s fyzickým handicapem



299.195.09
Cr 090.264.01

299.195.09
Cr 090.964.01

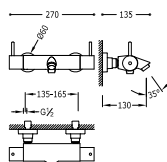

Vasca-Doccia termostatica

Doccetta anticalcare (299.631.03) con supporto orientabile.
Flessibile satin (91.34.609). Indicato per persone con disabilità fisiche.

Wall thermostatic shower mixer

Anti-limescale hand shower (299.631.03) with directable support.
Shower hose satin (91.34.609). Suitable for persons with physical disabilities.

Termostatická baterie pro vanu-sprchu

Ruční sprcha s nastavitelným držákem (299.631.03), proti usaz. vod. kamene a flexi hadice SATIN (91.34.609). Určeno pro osoby s fyzickým handicapem



299.195.09
Cr | 090.274.01



299.195.09
Cr | 090.974.01

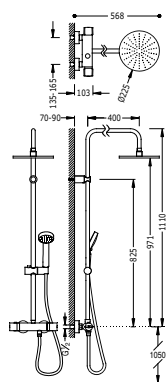

Set doccia termostatica

- Doccia fissa Ø 225 mm. con snodo. (299.632.01).
- Doccetta massaggio Ø 100 mm. (5 funzioni) (1.34.748).
- Flessibile satin (91.34.609.15).
- Invertitore integrato nel regolatore di portata.

Wall thermostatic shower mixer

- Fixed shower head Ø 225 mm. with ball joint. (299.632.01).
- Massage hand shower Ø 100 mm. (5 fonctions) (1.34.748).
- Satin hose (91.34.609.15).
- Diverter integrated in the flow control.

Souprava termostatické sprchové baterie

- Pevná sprcha Ø 225 mm. s kloubem. (299.632.01).
- Ruční masážní sprcha Ø 100 mm. (5 funkcí) (1.34.748).
- Flexi hadice SATIN (91.34.609.15).
- Přepínač zabudovaný v regulaci průtoku.



91.81.161.10
Cr | 1.81.385

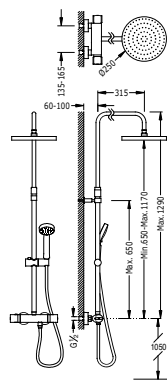

Set doccia termostatica

- Doccia fissa Ø 250 mm. con snodo. (1.34.137.26).
- Doccetta massaggio Ø 100 mm. (5 funzioni) (1.34.748).
- Flessibile satin (91.34.609.15).
- Asta telescopica.
- Invertitore integrato nel regolatore di portata.

Wall thermostatic shower mixer

- Fixed shower head Ø 250 mm. with ball joint. (1.34.137.26).
- Massage hand shower Ø 100 mm. (5 fonctions) (1.34.748).
- Satin hose (91.34.609.15).
- Telescopic bar.
- Diverter integrated in the flow control.

Souprava termostatické sprchové baterie

- Pevná sprcha Ø 250 mm. s kloubem. (1.34.137.26).
- Ruční masážní sprcha Ø 100 mm. (5 funkcí) (1.34.748).
- Flexi hadice SATIN (91.34.609.15).
- Teleskopická tyč.
- Přepínač zabudovaný v regulaci průtoku.



91.81.161.10
Cr | 1.90.214

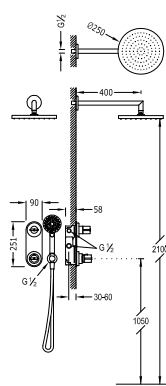

Kit doccia termostatica ad incasso

Con chiusura e regolazione di portata (2 vie).

- Corpo incassato termostatico incluso
- Doccia fissa Ø 250 mm. con snodo. (1.34.137.26).
- Supporto per doccia (205.182.01).
- Doccetta massaggio Ø 100 mm. (5 funzioni) (1.34.748).
- Tubo flessibile satin (91.34.609.15)

Concealed thermostatic shower kit

with water shut off and flow control (2 ways).

- Built-in thermostatic body included
- Fixed shower head Ø 250 mm. with ball joint. (1.34.137.26).
- Elbow wall (205.182.01).
- Massage hand shower Ø 100 mm. (5 fonctions) (1.34.748).
- Satin hose (91.34.609.15).

Podomítkový termostatický sprchový set

s uzávěrem a regulací průtoku (2-cestná).

- Včetně podomítkového termostatického tělesa
- Pevná sprcha Ø 250 mm. s kloubem. (1.34.137.26).
- Držák s nástěnným přívodem vody (205.182.01).
- Ruční masážní sprcha Ø 100 mm (5 funkcí) (1.34.748).
- Flexi hadice SATIN (91.34.609.15).



Cr 1.81.175

F



TRES

100

100

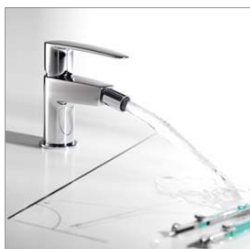

FLAT-TRES



Lavabi
Basin mixer taps
Koupelňová baterie
470



Bidet
Bidets
Bidety
470



Monocomando esterno
Bathtub mixer taps
Jednopákový mechanismus vany
470



Monocomando ad incasso
Built-in sets
Vestavné soupravy
471



Termostatica esterna
Thermostatically-controlled
Termostatické
472



Accessori
Accessories
Vybavení
343

www.tresgriferia.com



**RICAMBI SU
SPARE PARTS AT
NÁHRADNÍ DÍLY NA**
www.tresgriferia.com

LAVABI MONOCOMANDO / BASIN MIXER TAPS / KOUPELNOVÁ BATERIE

Ref. / Nr. / Kód:

Monocomando lavabo
Single lever washbasin mixer
Jednopáková umyvadlová baterie

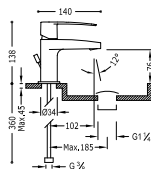

Cr 204.103.01



Cr 204.103.01.D

BIDET / BIDETS / BIDETY

Monocomando bidet
Single lever bidet mixer
Jednopáková bidetová baterie

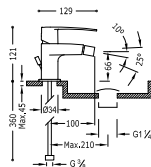

Cr 204.120.01



Cr 204.120.01.D

MONOCOMANDI BAGNO / BATHTUB MIXER TAPS / JEDNOPÁKOVÝ MECHANISMUS VANY

Monocomando doccia
Doccetta anticalcare (1.34.617) con supporto orientabile. Flessibile satin (91.34.609.15).

Single lever shower mixer
Anti-limescale hand shower (1.34.617) with directable support. Shower hose satin (91.34.609.15).

Jednopáková sprchová baterie
Ruční sprcha s nastavitelným držákem (1.34.617), proti usaz. vod. kamene a flexi hadice SATIN (91.34.609.15).

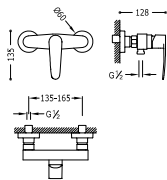

Cr 204.167.01

Monocomando vasca
Doccetta anticalcare (1.34.617) con supporto orientabile. Flessibile satin (91.34.609).

Single lever bath and shower mixer
Anti-limescale hand shower (1.34.617) with directable support. Shower hose satin (91.34.609).

Jednopáková baterie pro vanu-sprchu
Ruční sprcha, proti usaz. vod. kamene (1.34.617), proti usaz. vod. kamene a flexi hadice SATIN (91.34.609).

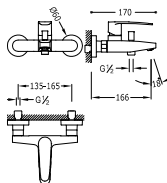

Cr 204.170.01

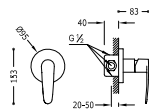

Monocomando incasso (1 vie)
corpo incassato incluso

Built-in mixer taps (1 way)
Built-in body included

Vestavěná jednopáková baterie (jednocestný)
včetně podomítkového tělesa

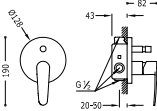

Monocomando incasso (2 vie)
corpo incassato incluso

Built-in mixer taps (2 way)
Built-in body included

Vestavěná jednopáková baterie (dvocestný)
včetně podomítkového tělesa

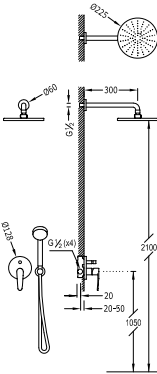

Kit doccia ad incasso

Con chiusura e regolazione di portata.
Corpo incassato incluso
· Doccia fissa Ø 225 mm. con snodo. (299.632.01).
· Supporto per doccia (205.182.01).
· Doccetta anticalcare (1.34.617).
· Flessibile satin (91.34.609.15).

Concealed shower set

with water shut off and flow control.
· Built-in body included
· Fixed shower head Ø 225 mm. with ball joint. (299.632.01).
· Elbow wall (205.182.01).
· Antilime hand shower (1.34.617).
· Satin hose (91.34.609.15).

Podomítkový jednopákový sprchový set

s uzávěrem a regulací průtoku.
· Včetně podomítkového tělesa
· Pevná sprcha Ø 225 mm. s kloubem. (299.632.01).
· Držák s nástěnným přívadem vody (205.182.01).
· Ruční sprcha, proti usaz. vod. kamene (1.34.617).
· Flexi hadice SATIN (91.34.609.15).

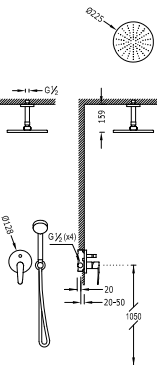

Kit doccia ad incasso

Con chiusura e regolazione di portata.
· Corpo incassato incluso
· Doccia fissa Ø 225 mm. con snodo. (299.632.01).
· Supporto per doccia (205.182.01).
· Doccetta anticalcare (1.34.617).
· Flessibile satin (91.34.609.15).

Concealed shower set

with water shut off and flow control.
· Built-in body included
· Fixed shower head Ø 225 mm. with ball joint. (299.632.01).
· Elbow wall (205.182.01).
· Antilime hand shower (1.34.617).
· Satin hose (91.34.609.15).

Podomítkový jednopákový sprchový set

s uzávěrem a regulací průtoku.
· Včetně podomítkového tělesa
· Pevná sprcha Ø 225 mm. s kloubem. (299.632.01).
· Držák s nástěnným přívadem vody (205.182.01).
· Ruční sprcha, proti usaz. vod. kamene (1.34.617).
· Flexi hadice SATIN (91.34.609.15).



TERMOSTATICHE / THERMOSTATICALLY-CONTROLLED / TERMOSTATICKÉ

Ref. / Nr. / Kód:

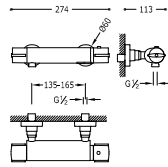

Doccia termostatica
 (Doccetta anticalcare (1.34.617) con supporto orientabile. Flessibile doppia graffatura (91.34.828)).

Wall thermostatic shower mixer
 (Anti-limescale hand shower (1.34.617) with directable support. Double interlocked shower hose (91.34.828)).

Termostatická sprchová baterie
 (Ruční sprcha, proti usaz. vod. kamene 80x80 mm. (1.34.617), proti usaz. vod. kamene a flexi hadice s dvojm zámekem (91.34.828)).



299.195.08
 Cr **204.196.01**

299.195.08
 Cr **204.196.03**

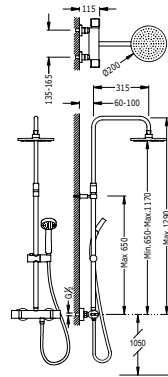

Set doccia termostatica
 · Doccia fissa Ø 200 mm. con snodo.
 · Doccetta anticalcare Ø 80 mm. (1.34.617).
 · Flessibile satin (91.34.609.15).
 · Asta telescopica.
 · Invertitore integrato nel regolatore di portata.

Wall thermostatic shower mixer
 · Fixed shower head Ø 200 mm. with ball joint.
 · Antilime hand shower Ø 80 mm. (1.34.617).
 · Satin hose (91.34.609.15).
 · Telescopic bar.
 · Diverter integrated in the flow control.

Souprava termostatické sprchové baterie
 · Pevná sprcha Ø 200 mm. s kloubem.
 · Ruční sprcha, proti usaz. vod. kamene Ø 80 mm. (1.34.617).
 · Flexi hadice SATIN (91.34.609.15).
 · Teleskopická tyč.
 · Přepínač zabudovaný v regulaci průtoku.



299.195.08
 Cr **204.387.03**

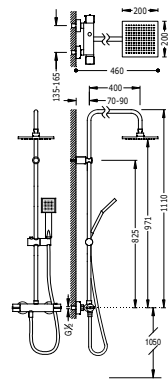

Set doccia termostatica
 · Doccia fissa 200x200 mm. con snodo.
 · Doccetta anticalcare 80x80 mm. (1.34.612).
 · Flessibile satin (91.34.609.15).
 · Invertitore integrato nel regolatore di portata.

Wall thermostatic shower mixer
 · Fixed shower head 200x200 mm. with ball joint.
 · Antilime hand shower 80x80 mm. (1.34.612).
 · Satin hose (91.34.609.15).
 · Diverter integrated in the flow control.

Souprava termostatické sprchové baterie
 · Pevná sprcha 200x200 mm. s kloubem.
 · Ruční sprcha, proti usaz. vod. kamene 80x80 mm. (1.34.612).
 · Flexi hadice SATIN (91.34.609.15).
 · Přepínač zabudovaný v regulaci průtoku.



299.195.08
 Cr **204.387.02**

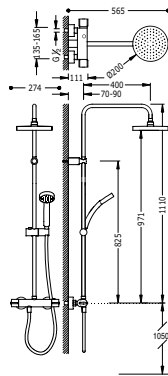

Set doccia termostatica

- Doccia fissa Ø 200 mm. con snodo.
- Doccetta anticalcare Ø 80 mm. (1.34.617).
- Flessibile satin (91.34.609.15).
- Invertitore integrato nel regolatore di portata.

Wall thermostatic shower mixer

- Fixed shower head Ø 200 mm. with ball joint.
- Antilime hand shower Ø 80 mm. (1.34.617).
- Satin hose (91.34.609.15).
- Diverter integrated in the flow control.

Souprava termostatické sprchové baterie

- Pevná sprcha Ø 200 mm. s kloubem.
- Ruční sprcha, proti usaz. vod. kamene Ø 80 mm. (1.34.617).
- Flexi hadice SÁTIN (91.34.609.15).
- Přepínač zabudovaný v regulaci průtoku.



299.195.08

Cr 204.387.01

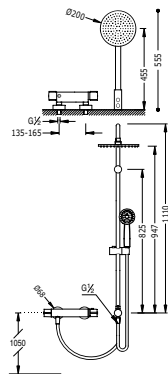

Set doccia termostatica

- Doccia fissa Ø 200 mm. con snodo.
- Doccetta anticalcare Ø 80 mm. (1.34.617).
- Flessibile satin (91.34.609.15).
- Invertitore integrato nel regolatore di portata.

Wall thermostatic shower mixer

- Fixed shower head Ø 200 mm. with ball joint.
- Antilime hand shower Ø 80 mm. (1.34.617).
- Satin hose (91.34.609.15).
- Diverter integrated in the flow control.

Souprava termostatické sprchové baterie

- Pevná sprcha Ø 200 mm. s kloubem.
- Ruční sprcha, proti usaz. vod. kamene Ø 80 mm. (1.34.617).
- Flexi hadice SÁTIN (91.34.609.15).
- Přepínač zabudovaný v regulaci průtoku.



299.195.08

Cr 204.385.01





K-TRES



Lavabi
Basin mixer taps
Koupelňová baterie
476



Bidets
Bidets
Bidety
477



Monocomando esterno
Bathtub mixer taps
Jednopákový mechanismus vany
477



Monocomando ad incasso
Built-in sets
Vestavné soupravy
478



Bordovasca
Deck-mounted bathtubs
Vany s prodlouženým pultem
479



Termostatica esterna
Thermostatically-controlled
Termostatické
480



Accessori
Accessories
Vybavení
343



**RICAMBI SU
SPARE PARTS AT
NÁHRADNÍ DÍLY NA**
www.tresgriferia.com

www.tresgriferia.com

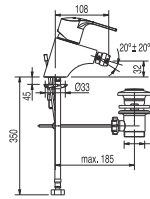

Monocomando bidet
Single lever bidet mixer
Jednopáková bidetová baterie

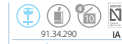

91.34.290
Cr | **1.69.120**

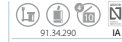

91.34.290
Cr | **1.69.120.DA**

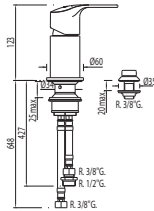

Monocomando bidet con doccia
Bidet mixer tap with small shower head
Jednopáková bidetová baterie se sprškou



91.34.385.10
Cr | **069.130.01**

MONOCOMANDI BAGNO / BATHTUB MIXER TAPS / JEDNOPÁKOVÝ MECHANISMUS VANY

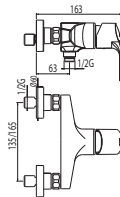

Monocomando doccia
Doccetta anticalcare con supporto orientabile. Flessibile doppia
graffatura

Single lever shower mixer
Anti-limescale hand shower with directable support. Double
interlocked shower hose

Jednopáková sprchová baterie
Ruční sprcha s nastavitelným držákem, proti usaz. vod. kamene.
Flexi hadice s dvojitým opletem



91.34.290
Cr | **069.167.02**

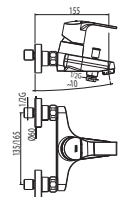

Monocomando vasca
Doccetta anticalcare con supporto orientabile. Flessibile doppia
graffatura

Single lever bath and shower mixer
Anti-limescale hand shower with directable support. Double
interlocked shower hose

Jednopáková baterie pro vanu-sprchu
Ruční sprcha s nastavitelným držákem, proti usaz. vod. kamene.
Flexi hadice s dvojitým opletem



91.34.290
Cr | **069.170.02**

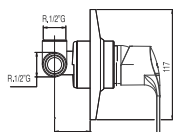

Monocomando incasso (1 via)
corpo incassato incluso

Built-in mixer taps (1 way)
Built-in body included

Vestavěná jednopáková baterie (jednocestný)
včetně podomítkového tělesa

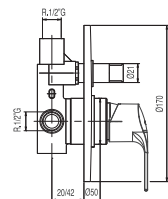

Monocomando incasso (2 vie)
corpo incassato incluso

Built-in mixer taps (2 way)
Built-in body included

Vestavěná jednopáková baterie (dvoucestný)
včetně podomítkového tělesa

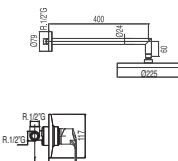

Kit doccia ad incasso

Con chiusura e regolazione di portata.
Corpo incassato incluso
· Doccia fissa Ø 225 mm. con snodo (299.632.01).

Concealed shower kit
with water shut off and flow control.
· **Built-in body included**
· **Fixed shower head Ø 225 mm. with ball joint (299.632.01).**

Sprchová sada vestavná
s uzávěrem a regulací průtoku.
· Včetně podomítkového tělesa
· Pevná sprcha Ø 225 mm. s kloubem (299.632.01).

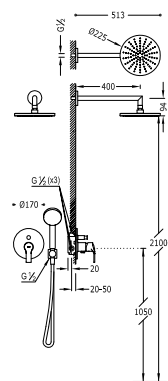

Kit doccia ad incasso

Con chiusura e regolazione di portata.
Corpo incassato incluso
· Doccia fissa Ø 225 mm. con snodo. (299.632.01).
· Supporto per doccia (205.182.01).
· Doccetta massaggio Ø 110 mm. (5 funzioni).
· Flessibile satin (91.34.609.15).

Concealed shower kit
with water shut off and flow control.
· **Built-in body included**
· **Fixed shower head Ø 225 mm. with ball joint. (299.632.01).**
· **Elbow wall (205.182.01).**
· **Massage hand shower Ø 110 mm. (5 fonctions).**
· **Satin hose (91.34.609.15).**

Sprchová sada vestavná
s uzávěrem a regulací průtoku.
· Včetně podomítkového tělesa
· Pevná sprcha Ø 225 mm. s kloubem. (299.632.01).
· Držák s nástěnným přívodem vody (205.182.01).
· Ruční masážní sprcha Ø 110 mm. (5 funkcí).
· Flexí hadice SATIN (91.34.609.15).



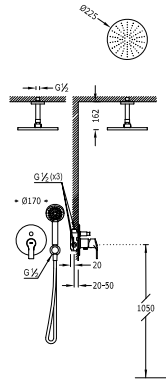

Kit doccia ad incasso

Con chiusura e regolazione di portata.

- Corpo incassato incluso
- Doccia fissa Ø 225 mm. con snodo. (299.632.01).
- Supporto per doccia (205.182.01).
- Doccetta massaggio Ø 110 mm. (5 funzioni).
- Flessibile satin (91.34.609.15).

Concealed shower kit

with water shut off and flow control.

- Built-in body included
- Fixed shower head Ø 225 mm. with ball joint. (299.632.01).
- Elbow wall (205.182.01).
- Massage hand shower Ø 110 mm. (5 fonctions).
- Satin hose (91.34.609.15).

Sprchová sada vestavná

s uzávěrem a regulací průtoku.

- Včetně podomítkového tělesa
- Pevná sprcha Ø 225 mm. s kloubem. (299.632.01).
- Držák s nástěnným přívodem vody (205.182.01).
- Ruční masážní sprcha Ø 110 mm. (5 funkcí).
- Flexi hadice SATIN (91.34.609.15).



91.34.290

Cr | **069.180.80**

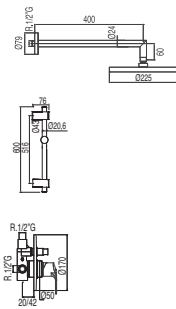

Kit doccia ad incasso

Con chiusura e regolazione di portata.

- Corpo incassato incluso
- Doccia fissa Ø 225 mm. con snodo. (299.632.01).
- Asta antiscivolo lunga 516 mm.
- Presa a parete (205.183.01).
- Doccetta Ø 110 mm. (5 funzioni).
- Flessibile satin (91.34.609.15).

Concealed bath & shower kit

with water shut off and flow control.

- Built-in body included
- Fixed shower head Ø 225 mm. with ball joint. (299.632.01).
- Sliding bar long. 516 mm.
- Elbow wall (205.183.01).
- Massage hand shower Ø 110 mm. (5 fonctions).
- Satin hose (91.34.609.15).

Sprchová sada vestavná

s uzávěrem a regulací průtoku.

- Včetně podomítkového tělesa
- Pevná sprcha Ø 225 mm. s kloubem. (299.632.01).
- Posuvná tyč 516 mm.
- Kolínko nástěnným přívodem (205.183.01).
- Ruční masážní sprcha Ø 110 mm. (5 funkcí).
- Flexi hadice SATIN (91.34.609.15).



91.34.290

Cr | **1.69.980**

BORDOVASCA / DECK-MOUNTED BATHTUBS / VANY S PRODLOUŽENÝM PULTEM

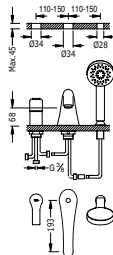

Monocomando bordo vasca

- Doccetta massaggio Ø 110 mm. (5 funzioni).
- Portata: 3 bar - 15 l/m.

Bath-shower single lever tap for bracket shelf

- Massage hand shower Ø 110 mm. (5 fonctions).
- Flowrate: 3 bar - 15 l/m.

Jednopáková vanová stojánková baterie

- Ruční masážní sprcha Ø 110 mm. (5 funkcí).
- Průtok: 3 bar - 15 l/m



91.34.288

Cr | **1.69.145**

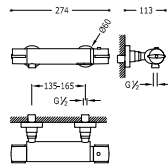
**Doccia termostatica**

(Doccetta anticalcare (1.34.617) con supporto orientabile. Flessibile doppia graffatura (91.34.828)).

Wall thermostatic shower mixer

(Anti-limescale hand shower (1.34.617) with directable support. Double interlocked shower hose (91.34.828)).

Termostatická sprchová baterie

(Ruční sprcha, proti usaz. vod. kamene 80x80 mm. (1.34.617), proti usaz. vod. kamene a flexi hadice s dvojitým zámkem (91.34.828)).

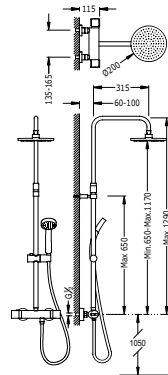
**Set doccia termostatica**

- Doccia fissa Ø 200 mm. con snodo.
- Doccetta anticalcare Ø 80 mm. (1.34.617).
- Flessibile satin (91.34.609.15).
- Asta telescopica.
- Invertitore integrato nel regolatore di portata.

Wall thermostatic shower mixer

- Fixed shower head Ø 200 mm. with ball joint.
- Antilime hand shower Ø 80 mm. (1.34.617).
- Satin hose (91.34.609.15).
- Telescopic bar.
- Diverter integrated in the flow control.

Souprava termostatické sprchové baterie

- Pevná sprcha Ø 200 mm. s kloubem.
- Ruční sprcha, proti usaz. vod. kamene Ø 80 mm. (1.34.617).
- Flexi hadice SATIN (91.34.609.15).
- Teleskopická tyč.
- Přepínač zabudovaný v regulaci průtoku.

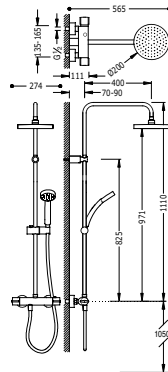
**Set doccia termostatica**

- Doccia fissa Ø 200 mm. con snodo.
- Doccetta anticalcare Ø 80 mm. (1.34.617).
- Flessibile satin (91.34.609.15).
- Invertitore integrato nel regolatore di portata.

Wall thermostatic shower mixer

- Fixed shower head Ø 200 mm. with ball joint.
- Antilime hand shower Ø 80 mm. (1.34.617).
- Satin hose (91.34.609.15).
- Diverter integrated in the flow control.

Souprava termostatické sprchové baterie

- Pevná sprcha Ø 200 mm. s kloubem.
- Ruční sprcha, proti usaz. vod. kamene Ø 80 mm. (1.34.617).
- Flexi hadice SATIN (91.34.609.15).
- Přepínač zabudovaný v regulaci průtoku.

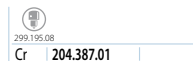

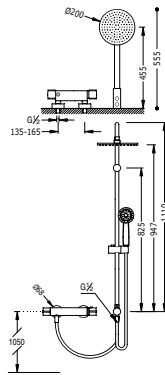

Set doccia termostatica

- Doccia fissa Ø 200 mm. con snodo.
- Doccetta anticalcare Ø 80 mm. (1.34.617).
- Flessibile satin (91.34.609.15).
- Invertitore integrato nel regolatore di portata.

Wall thermostatic shower mixer

- Fixed shower head Ø 200 mm. with ball joint.
- Antilime hand shower Ø 80 mm. (1.34.617).
- Satin hose (91.34.609.15).
- Diverter integrated in the flow control.

Souprava termostatické sprchové baterie

- Pevná sprcha Ø 200 mm. s kloubem.
- Ruční sprcha, proti usaz. vod. kamene Ø 80 mm. (1.34.617).
- Flexi hadice SATIN (91.34.609.15).
- Přepínač zabudovaný v regulaci průtoku.



Cr | 204.385.01







BM-TRES



Lavabi
Basin mixer taps
Koupelňová baterie
484



Bidets
Bidets
Bidety
485



Monocomando esterno
Bathtub mixer taps
Jednoplákový mechanismus vany
485



Monocomando ad incasso
Built-in sets
Vestavné soupravy
485



Bordovasca
Deck-mounted bathtubs
Vany s prodlouženým pultem
487



Accessori
Accessories
Vybavení
343

www.tresgriferia.com



**RICAMBI SU
SPARE PARTS AT
NÁHRADNÍ DÍLY NA**
www.tresgriferia.com

BIDET / BIDETS / BIDETY

Ref. / Nr. / Kód:

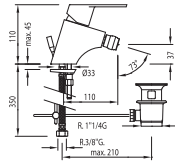

Monocomando bidé
Single lever washbasin mixer
Jednopáková bidetová baterie



Cr **1.39.120**



Cr **1.39.120.DA**

MONOCOMANDI BAGNO / BATHTUB MIXER TAPS / JEDNOPÁKOVÝ MECHANISMUS VANY

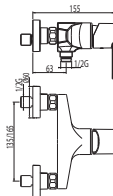

Monocomando doccia
Doccetta anticalcare con supporto orientabile. Flessibile doppia
graffatura

Single lever shower mixer
Anti-limescale hand shower with directable support. Double
interlocked shower hose

Jednopáková sprchová baterie
Ruční sprcha s nastavitelným držákem, proti usaz. vod. kamene.
Flexi hadice s dvojitým opletem



Cr **017.167.02**

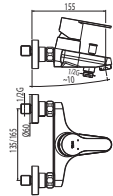

Monocomando vasca
Doccetta anticalcare con supporto orientabile. Flessibile doppia
graffatura

Single lever bath and shower mixer
Anti-limescale hand shower with directable support. Double
interlocked shower hose

Jednopáková baterie pro vanu-sprchu
Ruční sprcha s nastavitelným držákem, proti usaz. vod. kamene.
Flexi hadice s dvojitým opletem



Cr **017.170.02**

GRUPPI AD INCASSO / BUILT-IN SETS / VESTAVĚNÉ SOUPRAVY

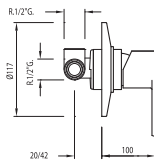

Monocomando incasso (1 via)
corpo incassato incluso
Built-in mixer taps (1 way)
Built-in body included

Vestavěná jednopáková baterie (jednocestný)
včetně podomítkového tělesa



Cr **017.177.12**

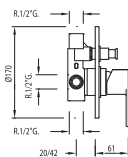

Monocomando incasso (2 vie)
corpo incassato incluso
Built-in mixer taps (2 way)
Built-in body included

Vestavěná jednopáková baterie (dvoucestný)
včetně podomítkového tělesa



Cr **017.180.12**



Kit doccia ad incasso
 Con chiusura e regolazione di portata.
 · Corpo incassato incluso
 · Doccia fissa Ø 225 mm. con snodo. (299.632.01).

Concealed shower kit
 with water shut off and flow control.
 · Built-in body included
 · Fixed shower head Ø 225 mm. with ball joint. (299.632.01).

Sprchová sada vestavná
 s uzávěrem a regulací průtoku.
 · Včetně podomítkového tělesa
 · Pevná sprcha Ø 225 mm. s kloubem. (299.632.01).

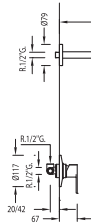

91.34.290

Cr 1.17.377



Kit doccia ad incasso
 Con chiusura e regolazione di portata.
 · Corpo incassato incluso
 · Doccia fissa Ø 225 mm. con snodo. (299.632.01).
 · Supporto per doccia (205.182.01).
 · Doccetta anticalcare Ø 100 mm.
 · Flessibile satin (91.34.609.15).

Concealed shower kit
 with water shut off and flow control.
 · Built-in body included
 · Fixed shower head Ø 225 mm. with ball joint. (299.632.01).
 · Elbow wall (205.182.01).
 · Shower Antilime Ø 100 mm.
 · Satin hose (91.34.609.15).

Sprchová sada vestavná
 s uzávěrem a regulací průtoku.
 · Včetně podomítkového tělesa
 · Pevná sprcha Ø 225 mm. s kloubem. (299.632.01).
 · Držák s nástěnným přívodem vody (205.182.01).
 · Sprcha, proti usaz. vod. kamene Ø 100 mm.
 · Flexi hadice SATIN (91.34.609.15).

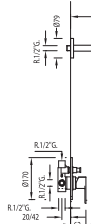

91.34.290

Cr 1.17.175



Kit doccia ad incasso
 Con chiusura e regolazione di portata.
 · Corpo incassato incluso
 · Doccia fissa Ø 225 mm. con snodo. (299.632.01).
 · Supporto per doccia (205.182.01).
 · Doccetta anticalcare Ø 100 mm.
 · Flessibile satin (91.34.609.15).

Concealed shower kit
 with water shut off and flow control.
 · Built-in body included
 · Fixed shower head Ø 225 mm. with ball joint. (299.632.01).
 · Elbow wall (205.182.01).
 · Shower Antilime Ø 100 mm.
 · Satin hose (91.34.609.15).

Sprchová sada vestavná
 s uzávěrem a regulací průtoku.
 · Včetně podomítkového tělesa
 · Pevná sprcha Ø 225 mm. s kloubem. (299.632.01).
 · Držák s nástěnným přívodem vody (205.182.01).
 · Sprcha, proti usaz. vod. kamene Ø 100 mm.
 · Flexi hadice SATIN (91.34.609.15).

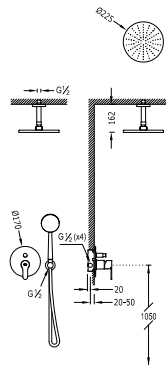

91.34.290

Cr 017.180.80

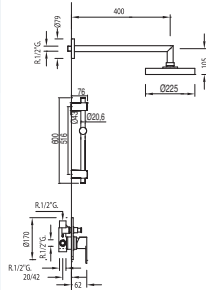

Kit doccia ad incasso

Con chiusura e regolazione di portata.

- Corpo incassato incluso
- Doccia fissa Ø 225 mm. con snodo. (299.632.01).
- Asta anticivolo lunga 516 mm.
- Presa a parete (205.183.01).
- Doccetta anticalcare Ø 100 mm.
- Flessibile satin (91.34.609.15).

Concealed bath & shower kit with water shut off and flow control.

- Built-in body included
- Fixed shower head Ø 225 mm. with ball joint. (299.632.01).
- Sliding bar long. 516 mm.
- Elbow wall (205.183.01).
- Shower Antilime Ø 100 mm.
- Satin hose (91.34.609.15).

Sprchová sada vestavná

s uzávěrem a regulací průtoku.

- Včetně podomítkového tělesa
- Pevná sprcha Ø 225 mm. s kloubem. (299.632.01).
- Posuvná tyč délky 516 mm.
- Kolínko nástěnným přívodem (205.183.01).
- Sprcha, proti usaz. vod. kamene Ø 100 mm.
- Flexi hadice SATIN (91.34.609.15).



BORDOVASCA / DECK-MOUNTED BATHTUBS / VANY S PRODLOUŽENÝM PULTEM

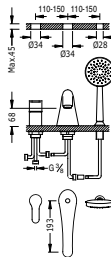

Monocomando bordo vasca

Doccetta anticalcare.

- Portata: 3 bar – 15 l/m.

Bath-shower single lever tap for bracket

Shower Antilime.

- Flowrate: 3 bar – 15 l/m.

Jednopáková stojánková vanová baterie

Sprcha, proti usaz. vod. kamene.

- Průtok: 3 bar – 15 l/m







MONOCLASIC 1900



Lavabi
Basin mixer taps
Koupelňová baterie
490



Bidet
Bidets
Bidety
490



Monocomando esterno
Bathtub mixer taps
Jednopákový mechanismus vany
491



Monocomando ad incasso
Built-in sets
Vestavné soupravy
491



Bordovasca
Deck-mounted bathtubs
Vany s prodlouženým pultem
492



Termostatica esterna
Thermostatically-controlled
Termostatické
493



Accessori
Accessories
Vybavení
350



**RICAMBI SU
SPARE PARTS AT
NÁHRADNÍ DÍLY NA**
www.tresgriferia.com

www.tresgriferia.com

LAVABI MONOCOMANDO / BASIN MIXER TAPS / KOUPELNOVÁ BATERIE

Ref. / Nr. / Kód:

Monocomando lavabo
Single lever washbasin mixer
Jednopáková umyvadlová baterie

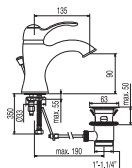

		91.34.290
Cr	1.42.103.02	
Lv	5.42.103.02.01	

		91.34.290
Cr	1.47.103.02	
Lv	5.47.103.02.01	

BIDET / BIDEETS / BIDEY

Monocomando bidet
Single lever bidet mixer
Jednopáková bidetová baterie

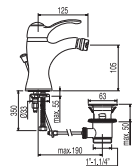

		91.34.290
Cr	1.42.120.02	
Lv	5.42.120.02.01	

		91.34.290
Cr	1.47.120.02	
Lv	5.47.120.02.01	



MONOCOMANDI BAGNO / BATHTUB MIXER TAPS / JEDNOPÁKOVÝ MECHANISMUS VANY

Ref. / Nr. / Kód:

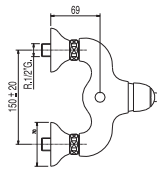

Monocomando doccia

Doccetta anticalcare con supporto orientabile. Flessibile doppia graffatura

Single lever shower mixer

Anti-limescale hand shower with directable support. Double interlocked shower hose

Jednopáková sprchová baterie

Ruční sprcha s nastavitelným držákem, proti usaz. vod. kamene. Flexi hadice s dvojitým opletem



91.34.290
Cr **1.42.167.02**
Lv **5.42.167.02.01**

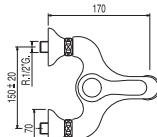

Monocomando vasca

Doccetta anticalcare con supporto orientabile. Flessibile doppia graffatura

Single lever bath and shower mixer

Anti-limescale hand shower with directable support. Double interlocked shower hose

Vanová baterie

Ruční sprcha s nastavitelným držákem, proti usaz. vod. kamene. Flexi hadice s dvojitým opletem



91.34.290
Cr **1.42.170.02**
Lv **5.42.170.02.01**

GRUPPI AD INCASSO / BUILT-IN SETS / VESTAVĚNÉ SOUPRAVY

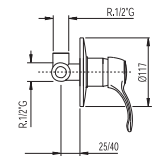

Monocomando incasso (1 via)

corpo incassato incluso

Built-in mixer taps (1 way)

Built-in body included

Vestavěná jednopáková baterie (jednocestný)
včetně podomítkového tělesa



91.34.290
Cr **042.177.12**

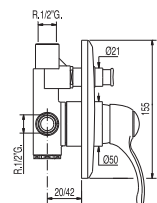

Monocomando incasso (2 vie)

corpo incassato incluso

Built-in mixer taps (2 way)

Built-in body included

Vestavěná jednopáková baterie (dvocestný)
včetně podomítkového tělesa



91.34.290
Cr **042.180.12**

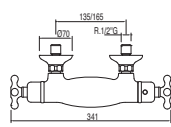

Doccia MONOCLASIC termostatica
Doccetta anticalcare con supporto orientabile. Flessibile doppia graffiatura

Wall thermostatic shower mixer MONOCLASIC
Anti-limescale hand shower with directable support. Double interlocked shower hose

Termostatická sprchová baterie MONOCLASIC
Ruční sprcha s nastavitelným držákem, proti usaz. vod. kamene. Flexi hadice s dvojitým opletem



299.195.10
299.195.10.LV

Cr **032.164.09**
Lv **032.164.09.LV**

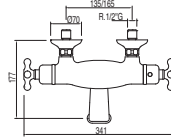

Bagno doccia MONOCLASIC termostatica
Doccetta anticalcare con supporto orientabile. Flessibile doppia graffiatura

Wall thermostatic bath and shower mixer MONOCLASIC
Anti-limescale hand shower with directable support. Double interlocked shower hose

Termostatická baterie pro vanu-sprchu MONOCLASIC
Ruční sprcha s nastavitelným držákem, proti usaz. vod. kamene. Flexi hadice s dvojitým opletem



299.195.10
299.195.10.LV

Cr **032.174.09**
Lv **032.174.09.LV**

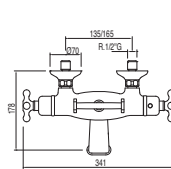

Bagno doccia MONOCLASIC termostatica
Doccetta anticalcare. Flessibile doppia graffiatura

Wall thermostatic bath and shower mixer MONOCLASIC
Shower Antilime. Double interlocked shower hose

Termostatická baterie pro vanu-sprchu MONOCLASIC
Ruční sprcha, proti usaz. vod. kamene a flexi hadice s dvojitým zámkem.



299.195.10
299.195.10.LV

Cr **032.176.09**
Lv **032.176.09.LV**

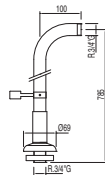

Prese d'acqua a terra per vasca da bagno
2 unità con supporto doccia girevole

Water intake at floor of bath
2 units with adjustable shower support

Vodovodní přípojky na okraj vany
2 kusy s otočným sprchovým držákem

Cr **1.24.194**
Lv **024.194.01.LV**

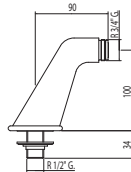

Gomito adattatore bagno-doccia
2 unità con silenziatore

Shower-bath elbow adaptor
2 units with silencer

Rohový ventil vana-sprcha
2 kusy s tlumičem

Cr **024.871.01**
Lv **024.871.01.LV**

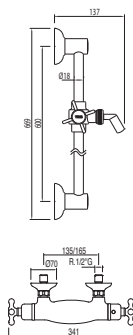

Kit doccia termostatica MONOCLASIC

- Asta antiscivolo RETRO lungo 550 mm.
- Doccetta anticalcare.
- Flessibile doppia graffatura.

Thermostatic bar-shower MONOCLASIC

- Sliding bar RETRO long. 550 mm.
- Shower Antilime.
- Double interlocked shower hose.

Sprchový set s termostatickou baterií MONOCLASIC

- Posuvná tyč RETRO o délce 550 mm.
- Ruční sprcha, proti usaz. vod. kamene.
- Flexi hadice s dvojitým opletem.



Cr	032.164.02
Lv	032.164.02.LV

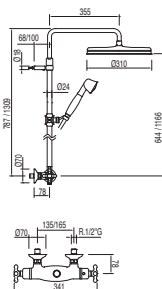

Set doccia MONOCLASIC termostatica

- Doccia fissa Ø 310 mm. con snodo.
- Doccetta anticalcare.
- Flessibile doppia graffatura.
- Asta telescopica.

Wall thermostatic shower mixer MONOCLASIC

- Fixed shower head Ø 310 mm. with ball joint.
- Shower Antilime.
- Double interlocked shower hose.
- Telescopic bar.

Souprava termostatické sprchové baterie MONOCLASIC

- Pevná sprcha Ø 310 mm. s kloubem.
- Ruční sprcha, proti usaz. vod. kamene.
- Hadice s dvojitým opletem.
- Teleskopická tyč.



Cr	032.195.02
Lv	032.195.02.LV

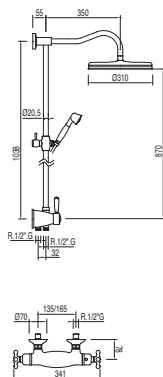

Set doccia MONOCLASIC termostatica

- Doccia fissa Ø 310 mm. con snodo. (299.337.03).
- Doccetta anticalcare (91.34.824).
- Flessibile doppia graffatura (91.34.828).

Wall thermostatic shower mixer MONOCLASIC

- Fixed shower head Ø 310 mm. with ball joint. (299.337.03).
- Shower Antilime (91.34.824).
- Double interlocked shower hose (91.34.828).

Souprava termostatické sprchové baterie MONOCLASIC

- Pevná sprcha Ø 310 mm. s kloubem. (299.337.03).
- Ruční sprcha, proti usaz. vod. kamene (91.34.824).
- Flexi hadice s dvojitým zámek (91.34.828).



Cr	032.195.01
----	------------



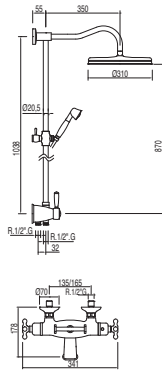

Idrodoccia MONOCLASIC termostatica

- Doccia fissa Ø 310 mm. con snodo. (299.337.03).
- Doccetta anticalcare (91.34.824).
- Flessibile doppia graffatura (91.34.828).

Wall thermostatic bath mixer MONOCLASIC

- Fixed shower head Ø 310 mm. with ball joint. (299.337.03).
- Shower Antilime (91.34.824).
- Double interlocked shower hose (91.34.828).

Souprava termostatické baterie pro vanu-sprchu MONOCLASIC

- Pevná sprcha Ø 310 mm. s kloubem. (299.337.03).
- Ruční sprcha, proti usaz. vod. kamene (91.34.824).
- Flexi hadice s dvojitým zámkem (91.34.828).



299.195.10

Cr **032.198.01**







CLASIC-TRES



Lavabi
Basin mixer taps
Koupelňová baterie
498



Bidet
Bidets
Bidety
499



Doppi comandi bagno
Bathroom dual control taps
Vanové baterie s dvoupákovým mechanismem
499



Bordovasca
Deck-mounted bathtubs
Vany s prodlouženým pultem
501



Termostatica esterna
Thermostatically-controlled
Termostatické
501



Accessori
Accessories
Vybavení
350

www.tresgriferia.com



**RICAMBI SU
SPARE PARTS AT
NÁHRADNÍ DÍLY NA**
www.tresgriferia.com

MONOBLOCCO LAVABO / SINGLE HOLE WASH-BASIN MIXER / DVOUPÁKOVÁ UMYVADLOVÁ BATERIE

Ref. / Nr. / Kód:

Monoblocco lavabo
Single hole wash-basin mixer
Dvoupáková umyvadlová baterie

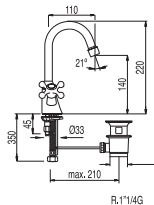

Cr 1.32.104
Lv 5.32.104.01



Cr 1.37.104
Lv 5.37.104.01

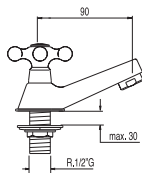

Rubinetto lavabo da 1/2"
1/2" basin pillar tap
Umyvadlová baterie 1/2"



Cr 1.32.100.F



Cr 1.32.100.C

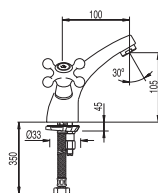

Monoblocco lavabo
Single hole wash-basin mixer
Dvoupáková umyvadlová baterie



Cr 1.32.103



Cr 1.37.103

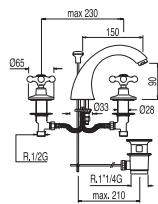

Accumulatore lavabo
Wash-basin mixer
Umyvadlová baterie



Cr 1.37.106
Lv 5.37.106.01

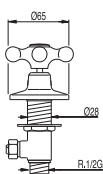

Rubinetto laterale
Lateral tap
Laterální baterie



Cr 1.32.510.F



Cr 1.32.510.C

MONOBLOCCO BIDET / SINGLE HOLE BIDET MIXER / DVÓUPÁKOVÁ BIDETOVÁ BATERIE

Ref. / Nr. / Kód:

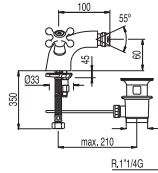

Monoblocco bidet
Single hole bidet mixer
Dvoupáková bidetová baterie

		Cr	1.32.120	
		Cr	1.37.120	

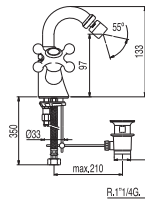

Monoblocco bidet
Single hole bidet mixer
Dvoupáková bidetová baterie

		Cr	1.32.124	
		Lv	5.32.124.01	
		Cr	1.37.124	
		Lv	5.37.124.01	

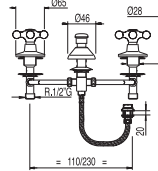

Accumulatore bidet
con doccetta
Single hole bidet mixer
with small shower head
Bidetová baterie
se sprškou

		Cr	1.32.130	
--	--	----	----------	--

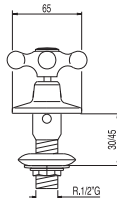

Rubinetto bidet da 1/2"
Bidet 1/2"
Bidetová baterie 1/2"

		Cr	1.32.125.F	
		Lv	5.32.125.01.F	
		Cr	1.32.125.C	
		Lv	5.32.125.01.C	

DOPPI COMANDI BAGNO / BATHROOM DUAL CONTROL TAPS / VANOVÉ BATERIE S DVÓUPÁKOVÝM MECHANISMEM

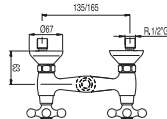

Gruppo doccia
Doccetta anticalcare con supporto orientabile. Flessibile doppia
graffatura

Shower mixer
Anti-limescale hand shower with directable support. Double
interlocked shower hose

Sprchový celek
Ruční sprcha s nastavitelným držákem, proti usaz. vod. kamene.
Flexi hadice s dvojitým opletem.

			Cr	1.32.768	
			Lv	5.32.765.01	

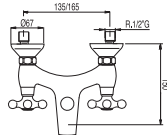

Gruppo vasca
Doccetta anticalcare con supporto orientabile. Flessibile doppia
graffatura

Bath and shower mixer
Anti-limescale hand shower with directable support. Double
interlocked shower hose

Set vana-sprcha
Ruční sprcha s nastavitelným držákem, proti usaz. vod. kamene.
Flexi hadice s dvojitým opletem.

			Cr	1.32.774	
			Lv	5.32.771.01	

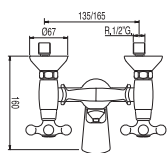

Gruppo vasca

Doccetta anticalcare. Flessibile doppia graffatura

Bath and shower mixer

Shower Antilime. Double interlocked shower hose

Set vana-sprcha

Sprcha, proti usaz. vod. kamene. Flexi hadice s dvojitým opletem.



Cr	1.32.176
Lv	5.32.176.01

ELEMENTI PER DOCCIA / SHOWER PARTS / SPRCHOVÉ PRVKY

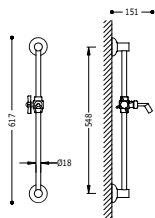

Asta antiscivolo RETRO

Sliding bar RETRO

Posuvná tyč RETRO

Cr	1.34.732
Lv	5.34.732.01
Ac	5.34.732.03

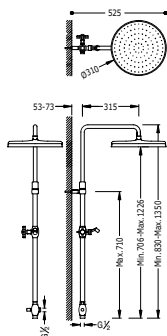

Asta telescopica CLASIC

Doccia fissa Ø 310 mm. con snodo.

Telescopic bar CLASIC

fixed shower head Ø 310 mm. with ball joint.

Teleskopická tyč CLASIC

Pevná sprcha Ø 310 mm. s kloubem. S rozdělovačem

Cr	024.213.01
Lv	024.213.01.LV

BORDOVASCA / DECK-MOUNTED BATHTUBS / VANY S PRODLOUŽENÝM PULTEM

Ref. / Nr. / Kód:

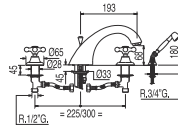

Batteria bordo vasca
con inventore.
· Portata: 3 bar – 12 l/m.

**Bath and shower mixer for bracket shelf
Inverter.**
· Flowrate: 3 bar – 12 l/m.

Stojánková vanová baterie
s přepínačem.
· Průtok: 3 bar – 12 l/m



Cr	1.32.145
Lv	5.32.145.01



Kit bordo vasca
Bath-shower kit cistern
Set nádrže pro stojánkové vanové baterie
(per ref. / for Nr. / Kód: 1.63.145, 1.32.145, 1.24.146).

Cr 1.34.345



Valvola vasca con presa drenaggio
Bath valve with drainage point
Odpadový vanový ventil

Cr 1.34.445



TERMOSTATICHE / THERMOSTATICALLY-CONTROLLED / TERMOSTATICKÉ

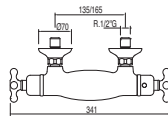

Doccia CLASIC termostatica
Doccetta anticalcare con supporto orientabile. Flessibile doppia
graffatura

Wall thermostatic shower mixer CLASIC
Anti-limescale hand shower with directable support. Double
interlocked shower hose

Termostatická sprchová baterie CLASIC
Ruční sprcha s nastavitelným držákem, proti usaz. vod. kamene.
Flexi hadice s dvojitým opletem.



Cr	032.164.09
Lv	032.164.09.LV

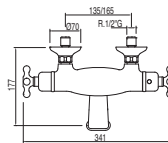

Bagno doccia CLASIC termostatica
Doccetta anticalcare con supporto orientabile. Flessibile doppia
graffatura

Wall thermostatic bath and shower mixer CLASIC
Anti-limescale hand shower with directable support. Double
interlocked shower hose

Termostatická baterie pro vanu-sprchu CLASIC
Ruční sprcha s nastavitelným držákem, proti usaz. vod. kamene.
Flexi hadice s dvojitým opletem.



Cr	032.174.09
Lv	032.174.09.LV

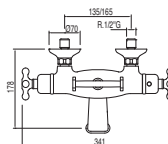

Bagno doccia CLASIC termostatica
Doccetta anticalcare. Flessibile doppia graffatura

Wall thermostatic bath and shower mixer CLASIC
Shower Antilime. Double interlocked shower hose

Termostatická baterie pro vanu-sprchu CLASIC s držákem.
Ruční sprcha proti usaz. vod. kamene a flexi hadice s dvojitým
opletem.



Cr	032.176.09
Lv	032.176.09.LV

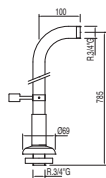

Prese d'acqua a terra per vasca da bagno
2 unità con supporto doccia girevole

Water intake at floor of bath
2 units with adjustable shower support

Vodovodní podlahové vanové přípojky
2 kusy s otočným sprchovým držákem

Cr	1.24.194
Lv	024.194.01.LV

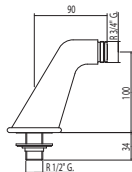

Gomito adattatore bagno-doccia
2 unità con silenziatore

Shower-bath elbow adaptor
2 units with silencer

Rohový ventil vana-sprcha
2 kusy s tlumičem

Cr	024.871.01
Lv	024.871.01.LV

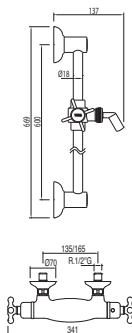

Kit doccia termostatica CLASIC
- Asta antiscivolo RETRO lungo 550 mm.
- Doccetta anticalcare.
- Flessibile doppia graffiatura.

Thermostatic bar-shower CLASIC

- Sliding bar RETRO long. 550 mm.
- Shower Antilime.
- Double interlocked shower hose.

Sprchový set s termostatickou baterií CLASIC

- Posuvná tyč RETRO o délce 550 mm.
- Ruční sprcha, proti usaz. vod. kamene.
- Flexi hadice s dvojitým opletem.

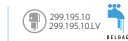

Cr	032.164.02
Lv	032.164.02.LV

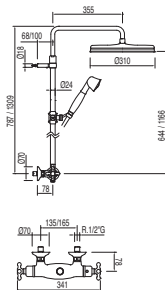

Set doccia CLASIC termostatica

- Doccia fissa Ø 310 mm. con snodo.
- Doccetta anticalcare.
- Flessibile doppia graffiatura.
- Asta telescopica.

Wall thermostatic shower mixer CLASIC

- Fixed shower head Ø 310 mm. with ball joint.
- Shower Antilime.
- Double interlocked shower hose.
- Telescopic bar.

Souprava termostatické sprchové baterie CLASIC

- Pevná sprcha Ø 310 mm. s kloubem.
- Ruční sprcha proti usaz. vod. kamene.
- Hadice s dvojitým opletem.
- Teleskopická tyč.

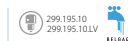

Cr	032.195.02
Lv	032.195.02.LV



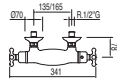
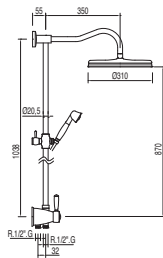

Set doccia CLASIC termostatica

- Doccia fissa Ø 310 mm. con snodo. (299.337.03).
- Doccetta anticalcare (91.34.824).
- Flessibile doppia graffatura (91.34.828).

Wall thermostatic shower mixer CLASIC

- Fixed shower head Ø 310 mm. with ball joint. (299.337.03).
- Shower Antilime (91.34.824).
- Double interlocked shower hose (91.34.828).

Souprava termostatické sprchové baterie CLASIC

- Pevná sprcha Ø 310 mm. s kloumem. (299.337.03).
- Ruční sprcha, proti usaz. vod. kamene (91.34.824).
- Flexi hadice s dvojitým opletem (91.34.828).

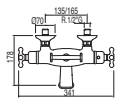
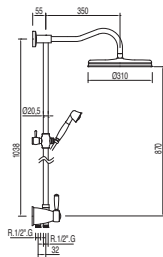

Idrodoccia CLASIC termostatica

- Doccia fissa Ø 310 mm. con snodo. (299.337.03).
- Doccetta anticalcare (91.34.824).
- Flessibile doppia graffatura (91.34.828).

Wall thermostatic bath mixer CLASIC

- Fixed shower head Ø 310 mm. with ball joint. (299.337.03).
- Shower Antilime (91.34.824).
- Double interlocked shower hose (91.34.828).

Souprava termostatické baterie pro vanu-sprchu CLASIC

- Pevná sprcha Ø 310 mm. s kloumem. (299.337.03).
- Ruční sprcha, proti usaz. vod. kamene (91.34.824).
- Flexi hadice s dvojitým opletem (91.34.828).



RUBINETTI DI ARRESTO / SHUTOFF VALVES / PRŮCHOZÍ VENTILY

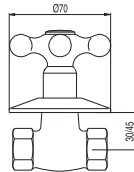

Rubinetto di arresto filettato 1/2"

1/2" threaded-ends gate-valve

Uzavírací ventil k zašroubování 1/2"



Cr 1.33.155.F
Lv 5.33.155.01.F



Cr 1.33.155.C
Lv 5.33.155.01.C

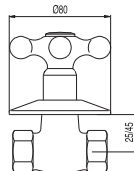

Rubinetto di arresto filettato 3/4"

3/4" threaded-ends gate-valve

Uzavírací ventil k zašroubování 3/4"



Cr 1.33.157.F
Lv 5.33.157.01.F



Cr 1.33.157.C
Lv 5.33.157.01.C





RETRO-TRES



Lavabi
Basin mixer taps
Koupelňová baterie
506



Bidet
Bidets
Bidety
508



Doppi comandi bagno
Bathroom dual control taps
Vanové baterie s dvoupákovým mechanismem
508



Monocomando ad incasso
Built-in sets
Vestavěné soupravy
510



Bordovasca
Deck-mounted bathtubs
Vany s prodlouženým pultem
511



Termostatica esterna
Thermostatically-controlled
Termostatické
512



Accessori
Accessories
Vybavení
350

www.tresgriferia.com



**RICAMBI SU
SPARE PARTS AT
NÁHRADNÍ DÍLY NA**
www.tresgriferia.com

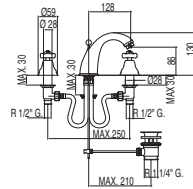

Accumulatore lavabo
Wash-basin mixer
Umyvadlová baterie



Cr	1.29.106	
Lv	5.29.106.01	

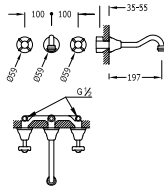

Accumulatore lavabo a muro
Wash-basin mixer
Nástěnná umyvadlová baterie

Cr	1.24.151	
Lv	5.24.151.01	

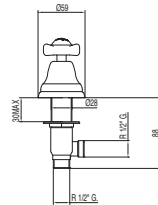

Rubinetto laterale
Lateral tap
Boční umyvadlová baterie



Cr	1.24.125.F	
Lv	5.24.125.01.F	



Cr	1.24.125.C	
Lv	5.24.125.01.C	

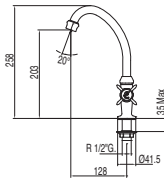

Rubinetto laterale
Lateral tap
Baterie s bočním ovládním



Cr	1.24.306	
----	----------	--

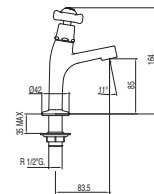

Rubinetto lavandino 1 acqua o premiscelata
1 water or premixed bathroom tap
Umyvadlová baterie pro jednu nebo předem smíchanou vodu

Cr	1.24.503	
----	----------	--

BIDET / BIDETS / DVOUPÁKOVÁ BIDETOVÁ BATERIE

Ref. / Nr. / Kód:

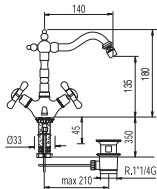

Monoblocco bidet
Single hole bidet mixer
Dvoupáková bidetová baterie



Cr	1.29.124.61
Lv	5.29.124.01.61
Ac	5.29.124.03.61

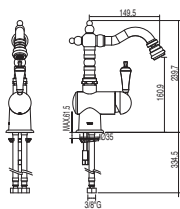

Monocomando bidet
Single lever bidet mixer
Jednopáková bidetová baterie



Cr	024.220.01
Lv	024.220.01.LV

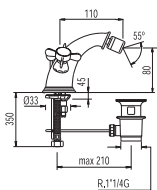

Monoblocco bidet
Single hole bidet mixer
Dvoupáková bidetová baterie



Cr	1.29.120.61
Lv	5.29.120.01.61
Ac	5.29.120.03.61

DOPPI COMANDI BAGNO / BATHROOM DUAL CONTROL TAPS / VANOVÉ BATERIE S DVOUPÁKOVÝM MECHANISMEM

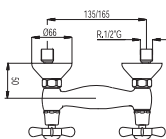

Gruppo doccia
Eccentrico con silenziatore. Doccetta anticalcare con supporto orientabile. Flessibile doppia graffatura.

Shower mixer
Excentric union with silencer. Anti-limescale hand shower with directable support. Double interlocked shower hose.

Sprchový celek
Excentry s tlumičem hluku. Ruční sprcha s nastavitelným držákem, proti usaz. vod. kamene. Flexi hadice s dvojitým opletem.



Cr	1.24.167.61
Lv	5.24.167.01.61
Ac	5.24.167.03.61

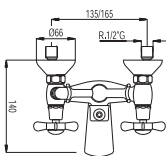

Gruppo vasca
Eccentrico con silenziatore. Doccetta anticalcare. Flessibile doppia graffatura

Bath and shower mixer
Excentric union with silencer. Antilime hand shower

Celek sprcha-vana
Excentry s tlumičem hluku. Ruční sprcha, proti usaz. vod. kamene a flexi hadice s dvojitým zámkem



Cr	1.24.170.61
Lv	5.24.170.01.61
Ac	5.24.170.03.61

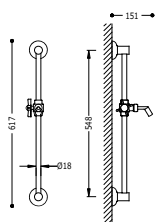

Asta antiscivolo RETRO
Sliding bar RETRO
Posuvná tyč RETRO

Cr	1.34.732	
Lv	5.34.732.01	

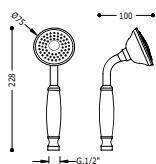

Doccetta anticalcare RETRO
Antilime shower RETRO
Sprcha, proti usaz. vod. kamene RETRO

Cr	1.24.824	
Lv	5.24.824.01	

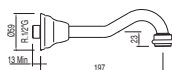

Canna RETRO
Spout RETRO
Nástěnné ramínko RETRO

Cr	1.24.173	
Lv	5.24.173.01	

GRUPPI AD INCASSO / BUILT-IN SETS / VESTAVĚNÉ SOUPRAVY

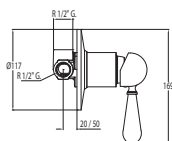

Monocomando incasso (1 via)
corpo incassato incluso
Built-in mixer taps (1 way)
Built-in body included
Vestavěná jednopáková baterie (jednocestný)
včetně podomítkového tělesa

91.34.290		
Cr	024.177.12	

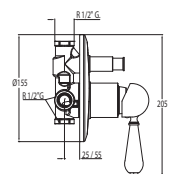

Monocomando incasso (2 vie)
corpo incassato incluso
Built-in mixer taps (2 way)
Built-in body included
Vestavěná jednopáková baterie (dvoucestný)
včetně podomítkového tělesa

91.34.290		
Cr	024.180.12	

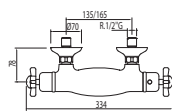

Doccia RETRO termostatica
Doccetta anticalcare con supporto orientabile. Flessibile doppia graffatura.

Wall thermostatic shower mixer RETRO
Anti-limescale hand shower with directable support. Double interlocked shower hose.

Termostatická sprchová baterie RETRO
Ruční sprcha s nastavitelným držákem, proti usaz. vod. kamene. Flexi hadice s dvojitým opletem.



Cr	024.164.09
Lv	024.164.09.LV

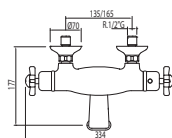

Bagno doccia RETRO termostatica
Doccetta anticalcare con supporto orientabile. Flessibile doppia graffatura.

Wall thermostatic bath and shower mixer RETRO
Anti-limescale hand shower with directable support. Double interlocked shower hose.

Termostatická baterie pro vanu-sprchu RETRO
Ruční sprcha s nastavitelným držákem, proti usaz. vod. kamene. Flexi hadice s dvojitým opletem.



Cr	024.174.09
Lv	024.174.09.LV

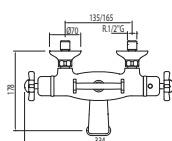

Bagno doccia RETRO termostatica
Doccetta anticalcare. Flessibile doppia graffatura.

Wall thermostatic bath and shower mixer RETRO
Anti-lime hand shower. Double interlocked shower hose.

Termostatická baterie pro vanu-sprchu RETRO
s držákem. Ruční sprcha, proti usaz. vod. kamene a flexi hadice s dvojitým zámkem.



Cr	024.176.09
Lv	024.176.09.LV

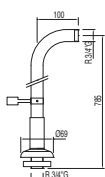

Prese d'acqua a terra per vasca da bagno
2 unità con supporto doccia girevole

Water intake at floor of bath
2 units with adjustable shower support

Vodovodní přípojky na okraj vany
2 kusy s otočným sprchovým držákem

Cr	1.24.194
Lv	024.194.01.LV

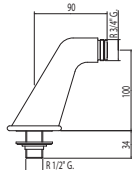

Gomitto adattatore bagno-doccia
2 unità con silenziatore

Shower-bath elbow adaptor
2 units with silencer

Rohový ventil vana-sprcha
2 kusy s tlumičem

Cr	024.871.01
Lv	024.871.01.LV

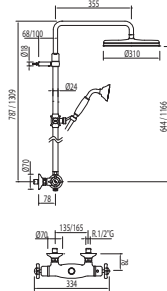

Set doccia RETRO termostatica

- Doccia fissa Ø 310 mm. con snodo.
- Doccetta anticalcare
- Flessibile doppia graffatura.
- Asta telescopica

Wall thermostatic shower mixer RETRO

- Fixed shower head Ø 310 mm. with ball joint.
- Shower Antilime.
- Double interlocked shower hose.
- Telescopic bar

Souprava termostatické sprchové baterie RETRO

- Pevná sprcha Ø 310 mm. s kloubem.
- Ruční sprcha, proti usaz. vod. kamene.
- Flexi hadice s dvojitým zámkem.
- Výsuvná tyč



	299.195.11 299.195.11.LV	
Cr	024.195.02	
Lv	024.195.02.LV	

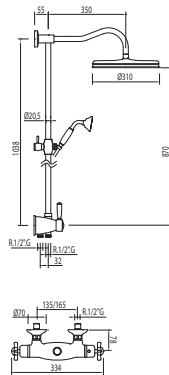

Set doccia RETRO termostatica

- Doccia fissa Ø 310 mm. con snodo. (299.337.03)
- Doccetta anticalcare (1.24.824).
- Flessibile doppia graffatura (91.34.828).

Wall thermostatic shower mixer RETRO

- Fixed shower head Ø 310 mm. with ball joint. (299.337.03)
- Shower Antilime (1.24.824).
- Double interlocked shower hose (91.34.828).

Souprava termostatické sprchové baterie RETRO

- Pevná sprcha Ø 310 mm. s kloubem. (299.337.03)
- Ruční sprcha, proti usaz. vod. Kamene (1.24.824).
- Flexi hadice s dvojitým zámkem (91.34.828).



	299.195.11 299.195.11.LV	
Cr	024.195.01	

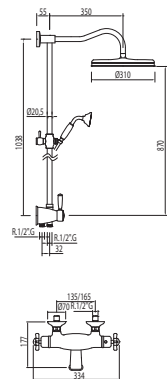

Idrodoccia RETRO termostatica

- Doccia fissa Ø 310 mm. con snodo. (299.337.03)
- Doccetta anticalcare (1.24.824).
- Flessibile doppia graffatura (91.34.828).

Wall thermostatic bath mixer RETRO

- Fixed shower head Ø 310 mm. with ball joint. (299.337.03)
- Shower Antilime (1.24.824).
- Double interlocked shower hose (91.34.828).

Souprava termostatické baterie pro vanu-sprchu RETRO

- Pevná sprcha Ø 310 mm. s kloubem. (299.337.03)
- Ruční sprcha, proti usaz. vod. Kamene (1.24.824).
- Flexi hadice s dvojitým zámkem (91.34.828).



	299.195.11 299.195.11.LV	
Cr	024.198.01	

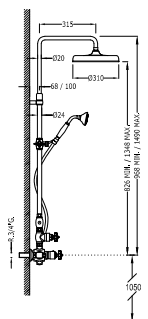

Termostatica doccia completa con presa acqua a parete

- Valvola antiritorno.
- Chiusura orientabile.
- Supporto doccia regolabile.
- Doccia fissa Ø 310 mm. con snodo.
- Flessibile doppia graffatura.
- Asta telescopica

Shower Thermostatic completed with water connections to the wall

- Bicuspid valve.
- Orientable closure.
- Adjustable shower holder.
- Fixed shower head Ø 310 mm. with ball joint.
- Double interlocked shower hose.
- Telescopic bar

Kompletní termost. sprchová baterie s nást. přívody vody

- Natáč. ventily proti zpětn. toku vody s uzávěrem.
- Nastavitelný držák sprchy.
- Pevná sprcha Ø 310 mm. s kloubem.
- Ruční sprcha, proti usaz. vod. kamene.
- Flexi hadice s dvojitým zámekm.
- Výsuvná tyč



91.94.161	RECOBAR
Cr	024.164.04
Lv	024.164.04.LV

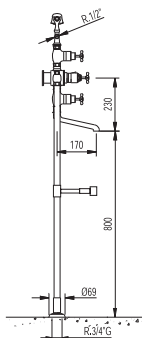

Termostatica vasca completa con presa di acqua a pavimento

- Valvola antiritorno con chiusura orientabile.
- Flessibile doppia graffatura.
- Doccetta anticalcare.

Thermostatic bath completed with water tubes to the floor

- Bicuspid valve with orientable closure.
- Double interlocked shower hose.
- Antilime showers.

Termostatická vanová baterie se sloupkovými podlahovými přívody vody

- Natáčecí ventily proti zpětnému toku vody s uzávěrem.
- Flexi hadice s dvojitým opletem.
- Sprcha, proti usaz. vod. kamene



91.94.161	RECOBAR
Cr	1.90.194
Lv	5.90.194.01

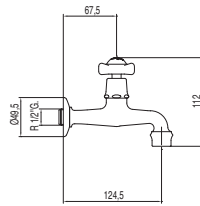

Rubinetto office
Kitchenette tap
Kuchyňská baterie

Cr 1.24.520

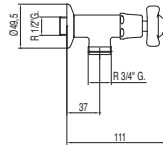

Rubinetto lavatrice
3/4" Avvitare
Washing machine tap
3/4"
Kohoutek pro pračku
Výstup - závit 3/4"

Cr 1.24.500

RUBINETTI DI ARRESTO / SHUTOFF VALVES / PRŮCHOZÍ VENTILY

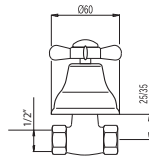

Rubinetto di arresto filettato
1/2"
Valve
1/2"
Uzavírací ventil
1/2"

F 200
Cr 1.24.155.61.F
Lv 5.24.155.01.61.F

C 200
Cr 1.24.155.61.C
Lv 5.24.155.01.61.C

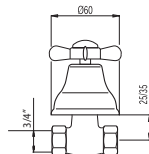

Rubinetto di arresto filettato
3/4"
Valve
3/4"
Uzavírací ventil
3/4"

F 200
Cr 1.24.157.61.F
Lv 5.24.157.01.61.F

C 200
Cr 1.24.157.61.C
Lv 5.24.157.01.61.C







CUCINA KITCHEN KUCHYNĚ



Monocomando
Mixer taps
S jednopákovým mechanismem
520



Con manico estraibile
With detachable spray nozzle
S výsuvnou sprškou
528



Reclinabile
Folding kitchen taps
Dřezová sklopná baterie
532



Electronica
Electronic kitchen taps
Dřezové elektronické baterie
533



Sistema trattamento acqua
For water treatment
Dřezová baterie k úpravě vody
534



Industriale
Industrial kitchen taps
Dřezová průmyslová baterie
536



Cucina a parete
Wall kitchen
Nástěnné kuchyňské baterie
538



Doppio comando
Dual-control
Dřezová kohoutková baterie
541

www.tresgriferia.com



**RICAMBI SU
SPARE PARTS AT
NÁHRADNÍ DÍLY NA**
www.tresgriferia.com

**CUCINE DA GODERSI
ENJOYABLE KITCHENS
POTĚŠENÍ Z KUCHYNĚ**



Caratteristiche generali / General characteristics / Všeobecné vlastnosti

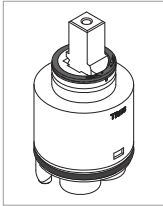

Cartuccia ceramica brevettata®. La cartuccia TRES evita l'usura dei dischi quando il rubinetto è chiuso, prolungandone la durata. / **Patented® Ceramic Cartridge.** The TRES cartridge prevents wear and tear of the disks with the tap closed, thus lengthening its useful life. / Keramická kartuš Patentado®. Kartuš TRES zabraňuje opotrebení disků v době, kdy je baterie zavřená, čímž prodlužuje její životnost.

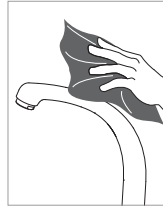

Cromatura per tutta la vita. La cromatura TRES-MICRON® è duratura e facile da pulire. / **Durable chrome plating.** Tres-Micron® chrome plating is durable and easy to clean. / Chromování na celý život. Chromování Tres-Micron® je trvanlivé a snadno se čistí.

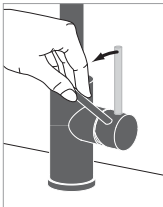

Manopola con rotazione frontale. Evita che la manopola sbatta contro la parete. / **Front rotating handle.** Prevents the handle from hitting the wall. / Páka s čelní rotací. Zabraňuje narážení páky do stěny.

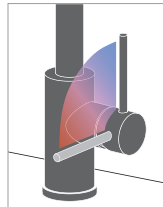

Risparmio energetico con Cold-Tres®. Il rubinetto si apre sempre con l'acqua fredda, evitando inutili accensioni dello scaldabagno. / **Cold-Tres® energy savings.** The tap always turns on with cold water, preventing unnecessary activation of the water heater. / Úspora energie Cold-Tres®. Baterie se vždy spouští se studenou vodou a zamezují tak zbytečnému spouštění ohřivače.

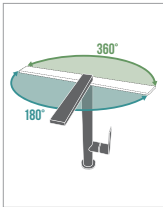

Canna girevole. A seconda dei modelli, canne con rotazione limitata a 180° oppure con completa libertà di movimento a 360°. / **Rotating spout.** Depending on models, spouts that rotate up to 180° or to 360° with total freedom of movement. / Otočná trubice. Podle modelů, trubice s omezeným otáčením o 180° či naprostá volnost pohybu, 360°.

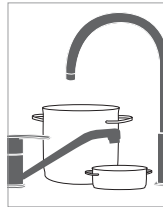

Altezza di comfort. Le canne con differenti altezze sono ideali per piani cucina speciali. / **Comfortable heights.** Spouts of different heights are ideal for special countertops. / Pohodlná výška. Kohoutky s různými výškami jsou ideální pro speciální pracovní plochy.

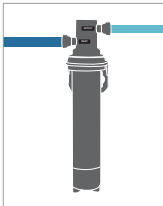

Filtro anticloro. Assicura un basso contenuto di cloro, per cui elimina il cattivo sapore dell'acqua, ma al tempo stesso rispetta le proprietà minerali dell'acqua di rete. / **Anti-chlorine filter.** This ensures a low level of chlorine, preventing the water from tasting bad, while still respecting the mineral properties of the mains water. / Filtř proti chlóru. zaručuje nízké hodnoty chlóru a tím i odstranění nepřijemné příchuti vody, přičemž respektuje minerální složení vody z vodovodu.

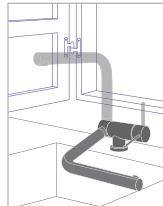

Reclinabile. Ideale per l'installazione di fronte a finestre o armadi. All'occorrenza questa rubinetteria si può girare e reclinare. / **Folding.** Ideal when installed in front of windows or cupboards. This tapware can be turned and lowered as required. / Sklápěcí. Ideální pro instalaci u oken či skříněk. Tato baterie nabízí v případě nutnosti možnost otočení a sklopení.



Canna o doccia retrattile. Aumenta il raggio d'azione e può offrire diversi tipi di getti. / **Retractable spout or shower.** Increases the radius of action and has different jet types. / Zatahovací sprcha či trubice. Zvyšuje akční rádius sprchy, přičemž nabízí různé typy výstupů vody.

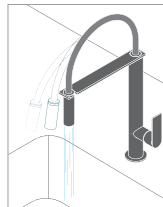

Canna estraibile. Permette di estendere la zona di lavoro da 50 a 70 cm. / **Detachable spout.** Enabling the operating area to be widened from 50 to 70 cm. / Výsuvná trubice. Umožňuje zvětšení pracovní plochy o 50 až 70 cm.



CUCINA MONOCOMANDO / KITCHEN MIXER TAPS / DŘEZOVÉ BATERIE S JEDNOPÁKOVÝM MECHANISMEM

Ref. / Nr. / Kod:

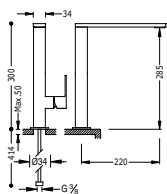

Monocomando lavello verticale CUADRO-TRES
canna 34x10 mm.

Single lever single hole sink mixer CUADRO-TRES
spout 34x10 mm

Jednopáková dřezová kuchyňská baterie CUADRO-TRES
ramínko 34x10 mm

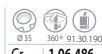

Cr 1.06.486

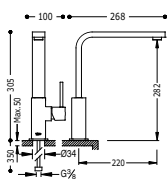

Monocomando lavello verticale CUADRO-TRES
Canna tubo 35x15 mm.

Single lever single hole sink mixer CUADRO-TRES
Tube spout 35x15 mm.

Jednopáková dřezová kuchyňská baterie CUADRO-TRES
ramínko 35x15 mm



Cr 1.30.496

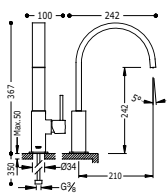

Monocomando lavello verticale CUADRO-TRES
Canna tubo 35x15 mm. Aeratore rettangolare

Single lever single hole sink mixer CUADRO-TRES
Tube spout 35x15 mm. Rectangular Aerator

Jednopáková dřezová kuchyňská baterie CUADRO-TRES
ramínko 35x15 mm se skrytým obdélníkovým perlátorem



Cr 1.30.498

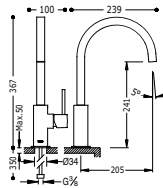

Monocomando lavello verticale CUADRO-TRES

Canna tubo 22x22 mm.

Single lever single hole sink mixer CUADRO-TRES

Tube spout 22x22 mm.

Jednopáková dřezová kuchyňská baterie CUADRO-TRES
ramínko 22x22 mm



Cr 1.30.497

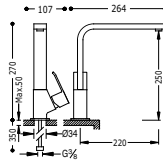

Monocomando lavello verticale CUADRO-TRES

Canna tubo 35x15 mm.

Single lever single hole sink mixer CUADRO-TRES

Tube spout 35x15 mm.

Jednopáková dřezová kuchyňská baterie CUADRO-TRES
ramínko 35x15 mm



Cr 1.06.440

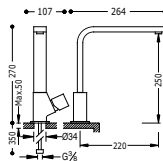

Monocomando lavello verticale CUADRO-TRES

Canna tubo 35x15 mm.

Single lever single hole sink mixer CUADRO-TRES

Tube spout 35x15 mm.

Jednopáková dřezová kuchyňská baterie CUADRO-TRES
ramínko 35x15 mm



Cr 1.07.440

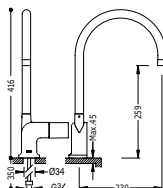

Monocomando lavello verticale

Single lever single hole sink mixer

Jednopáková dřezová kuchyňská baterie



Cr 1.87.440

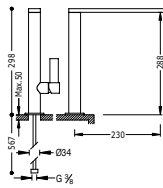

Monocomando lavello verticale CLASS-TRES

canna 34x9 mm.

Single lever single hole sink mixer CLASS-TRES

spout 34x9 mm.

Jednopáková dřezová kuchyňská baterie CLASS-TRES
ramínko 34x9 mm



Cr 205.486.01

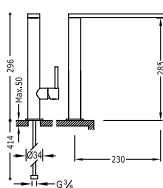

Monocomando lavello verticale MAX-TRES

canna 34x9 mm.

Single lever single hole sink mixer MAX-TRES

spout 34x9 mm.

Jednopáková dřezová kuchyňská baterie MAX-TRES
ramínko 34x9 mm



Cr 062.488.01



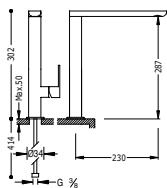

Monocomandoavello verticale LOFT-TRES
canna 34x15 mm.

Single lever single hole sink mixer LOFT-TRES
spout 34x15 mm.

Jednopáková dřezová kuchyňská baterie LOFT-TRES
ramínko 34x15 mm



Cr 200.440.01

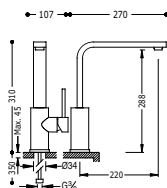

Monocomandoavello verticale
Canna tubo 35x15 mm.

Single lever single hole sink mixer
Tube spout 35x15 mm.

Jednopáková dřezová kuchyňská baterie
ramínko 35x15 mm



Cr 1.62.435

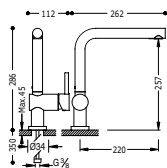

Monocomandoavello verticale
Single lever single hole sink mixer

Jednopáková dřezová kuchyňská baterie



Cr 1.30.336

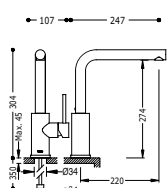

Monocomandoavello verticale MAX-TRES
Single lever single hole sink mixer MAX-TRES

Jednopáková dřezová kuchyňská baterie MAX-TRES



Cr 1.62.436

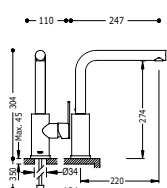

Monocomandoavello verticale LEX-TRES
Single lever single hole sink mixer LEX-TRES

Jednopáková dřezová kuchyňská baterie LEX-TRES



Cr 1.81.436

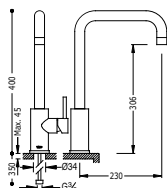

Monocomandoavello verticale MAX-TRES
Single lever single hole sink mixer MAX-TRES

Jednopáková dřezová kuchyňská baterie MAX-TRES



Cr 1.62.541

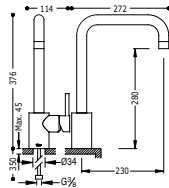

Monocomando lavello verticale MAX-TRES
Single lever single hole sink mixer MAX-TRES
Jednopáková dřezová kuchyňská baterie MAX-TRES

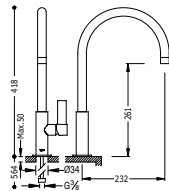
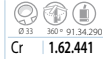

Monocomando lavello verticale CLASS-TRES
Single lever single hole sink mixer CLASS-TRES
Jednopáková dřezová kuchyňská baterie CLASS-TRES

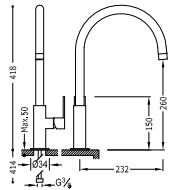

Monocomando lavello verticale LOFT-TRES
Single lever single hole sink mixer LOFT-TRES
Jednopáková dřezová kuchyňská baterie LOFT-TRES

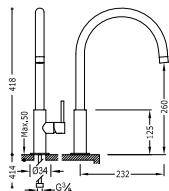

Monocomando lavello verticale MAX-TRES
Single lever single hole sink mixer MAX-TRES
Jednopáková dřezová kuchyňská baterie MAX-TRES

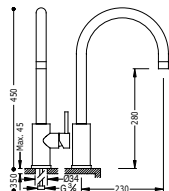

Monocomando lavello verticale MAX-TRES
Single lever single hole sink mixer MAX-TRES
Jednopáková dřezová kuchyňská baterie MAX-TRES

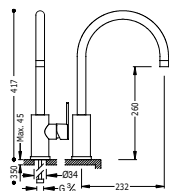
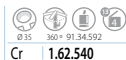

Monocomando lavello verticale LEX-TRES
Single lever single hole sink mixer LEX-TRES
Jednopáková dřezová kuchyňská baterie LEX-TRES



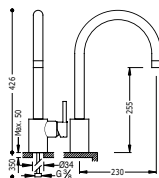

Monocomando lavello verticale MAX-TRES
Single lever single hole sink mixer MAX-TRES
Jednopáková dřezová kuchyňská baterie MAX-TRES



Cr 1.62.440

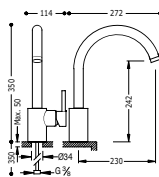

Monocomando lavello verticale MAX-TRES
Single lever single hole sink mixer MAX-TRES
Jednopáková dřezová kuchyňská baterie MAX-TRES



Cr 1.62.442

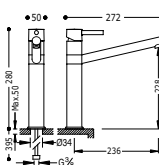

Monocomando lavello verticale ALPLUS
canna lunga
Single lever single hole sink mixer ALPLUS
tube spout
Jednopáková dřezová kuchyňská baterie ALPLUS
dlouhé ramínko



Cr 1.83.333

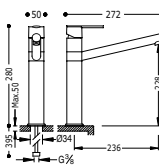

Monocomando lavello verticale LEX-TRES
canna lunga
Single lever single hole sink mixer LEX-TRES
tube spout
Jednopáková dřezová kuchyňská baterie LEX-TRES
dlouhé ramínko



Cr 1.81.333

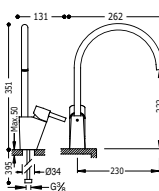

Monocomando lavello verticale ALPLUS
Single lever single hole sink mixer ALPLUS
Jednopáková dřezová kuchyňská baterie ALPLUS



Cr 1.83.341

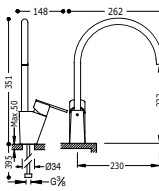

Monocomando lavello verticale LEX-TRES
Single lever single hole sink mixer LEX-TRES
Jednopáková dřezová kuchyňská baterie LEX-TRES



Cr 1.81.341

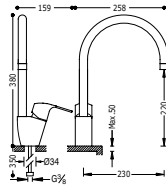

Monocomando lavello verticale K-TRES
Single lever single hole sink mixer K-TRES
Jednopáková dřezová kuchyňská baterie K-TRES



Cr 1.69.440

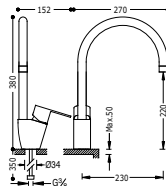

Monocomando lavello verticale BM-TRES
Single lever single hole sink mixer BM-TRES
Jednopáková dřezová kuchyňská baterie BM-TRES



Cr 1.17.440

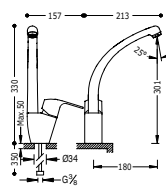

Monocomando lavello verticale K-TRES
Single lever single hole sink mixer K-TRES
Jednopáková dřezová kuchyňská baterie K-TRES



Cr 069.440.01

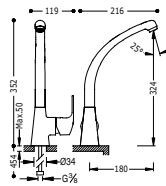

Monocomando lavello verticale K-TRES
Single lever single hole sink mixer K-TRES
Jednopáková dřezová kuchyňská baterie K-TRES



Cr 069.447.01

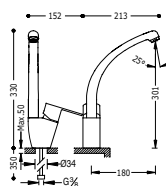

Monocomando lavello verticale BM-TRES
Single lever single hole sink mixer BM-TRES
Jednopáková dřezová kuchyňská baterie BM-TRES



Cr 017.440.01

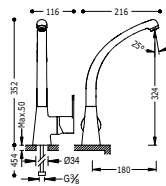

Monocomando lavello verticale BM-TRES
Single lever single hole sink mixer BM-TRES
Jednopáková dřezová kuchyňská baterie BM-TRES



Cr 017.447.02

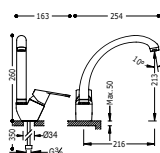

Monocomandoavello verticale BM-TRES
Single lever single hole sink mixer BM-TRES
Jednopáková dřezová kuchyňská baterie BM-TRES



Cr | 1.39.441

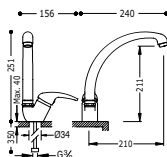

Monocomandoavello verticale BASIC
Single lever single hole sink mixer BASIC
Jednopáková dřezová kuchyňská baterie BASIC



Cr | 1.30.338

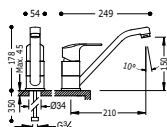

Monocomandoavello verticale K-TRES
Single lever single hole sink mixer K-TRES
Jednopáková dřezová kuchyňská baterie K-TRES



Cr | 1.69.333

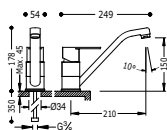

Monocomandoavello verticale BM-TRES
Single lever single hole sink mixer BM-TRES
Jednopáková dřezová kuchyňská baterie BM-TRES



Cr | 1.17.333

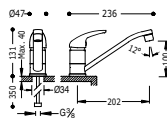

Monocomandoavello verticale BASIC
Single lever single hole sink mixer BASIC
Jednopáková dřezová kuchyňská baterie BASIC



Cr | 1.30.337

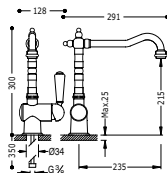

Monocomandoavello verticale RETRO-TRES
Single lever single hole sink mixer RETRO-TRES
Jednopáková dřezová kuchyňská baterie RETRO-TRES



Cr | 1.24.341

Lv | 5.24.341.01

Ac | 5.24.341.03

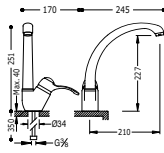

Monocomandoavello verticale MONOCLASIC-1900
Single lever single hole sink mixer MONOCLASIC-1900
Jednopaková dřezová kuchyňská baterie MONOCLASIC-1900



Cr	1.42.441.02
Lv	5.42.441.02.01
Ac	5.42.441.02.03

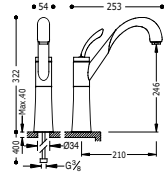

Monocomandoavello verticale
Single lever single hole sink mixer
Jednopaková dřezová baterie svislá



Cr	1.13.333
----	----------



CUCINA CON MANICO ESTRAIBILE / KITCHEN TAPS WITH DETACHABLE SPRAY NOZZLE / DŘEZOVÁ BATERIE S VÝSUVNOU SPRŠKOU

Ref. / Nr. / Kód:

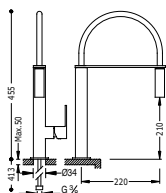

Monocomando lavello verticale CUADRO-TRES estraibile

Single lever single hole sink mixer CUADRO-TRES with removable spout

Jednopáková dřezová kuchyňská baterie CUADRO-TRES s vyjímatelným kropicítkem



Cr 1.06.487

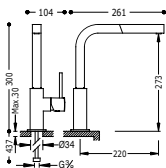

Monocomando lavello verticale CUADRO-TRES estraibile

Single lever single hole sink mixer CUADRO-TRES with removable spout

Jednopáková dřezová kuchyňská baterie CUADRO-TRES s vyjímatelným kropicítkem



Cr 1.06.437

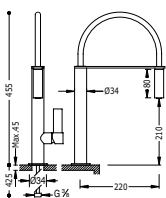

Monocomando lavello verticale CLASS-TRES estraibile

Single lever single hole sink mixer CLASS-TRES with removable spout

Jednopáková dřezová kuchyňská baterie CLASS-TRES s vyjímatelným kropicítkem



Cr 205.487.01

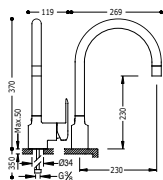

Monocomando lavello verticale
estraibile

Single lever single hole sink mixer
with removable spout

Jednopáková dřezová baterie svislá
s vyjímatelným kropítkem



Cr 1.14.444

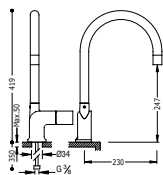

Monocomando lavello verticale
estraibile

Single lever single hole sink mixer
with removable spout

Jednopáková dřezová baterie svislá
s vyjímatelným kropítkem



Cr 1.87.444

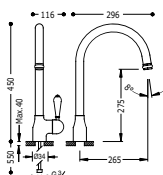

Monocomando lavello verticale RETRO-TRES
estraibile

Single lever single hole sink mixer RETRO-TRES
with removable spout

Jednopáková dřezová kuchyňská baterie RETRO-TRES
s vyjímatelným kropítkem



Cr 1.30.432

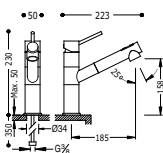

Monocomando lavello verticale
estraibile (2 funzioni)

Single lever single hole sink mixer
with removable spout (2 operations)

Jednopáková dřezová kuchyňská baterie
s vyjímatelnou sprškou (2 funkce)



Cr 1.30.434

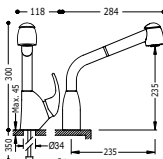

Monocomando lavello verticale
estraibile (2 funzioni)

Single lever single hole sink mixer
with removable spout (2 operations)

Jednopáková dřezová kuchyňská baterie
s vyjímatelnou sprškou (2 funkce)



Cr 030.444.01

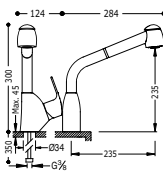

Monocomando lavello verticale K-TRES
estraibile (2 funzioni)

Single lever single hole sink mixer K-TRES
with removable spout (2 operations)

Jednopáková dřezová kuchyňská baterie K-TRES
s vyjímatelnou sprškou (2 funkce)



Cr 069.444.01

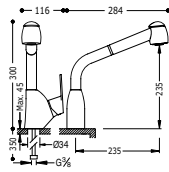

Monocomando lavello verticale BM-TRES
estraibile (2 funzioni)

Single lever single hole sink mixer BM-TRES
with removable spout (2 operations)

Jednopáková dřezová baterie svislá BM-TRES
s vyjímatelnou sprškou (2 funkce)





CUCINA RECLINABILE / FOLDING KITCHEN TAPS / DŘEZOVÁ BATERIE SKLOPNÁ

Ref./Nr./Kód:

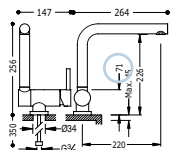

Monocomando livello verticale ABBATTIBILE
Single lever single hole sink mixer FOLDING
Jednopáková dřezová kuchyňská baterie SKLOPNÁ



Cr 1.30.335

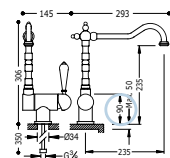

Monocomando livello verticale ABBATTIBILE
RETRO-TRES
Single hole sink mixer FOLDING RETRO-TRES
Jednopáková dřezová kuchyňská baterie SKLOPNÁ
RETRO-TRES



Cr	1.24.334
Lv	5.24.334.01
Co	5.24.334.02
Ac	5.24.334.03



1.61.445

Un'acqua

Only cold water

Pro studenou vodu (nebo
vstupně smíšenou)

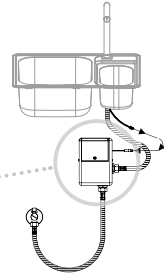
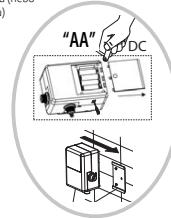

1.61.446

Miscelatore

Cold and warm water

Se směšovačem



1.92.507.30

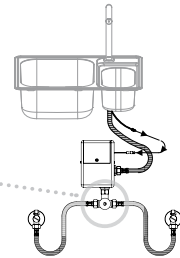

CUCINA ELETTRONICA / ELECTRONIC KITCHEN TAPS / DŘEVĚVÉ ELEKTRONICKÉ BATERIE

Ref./Nr./Kód:

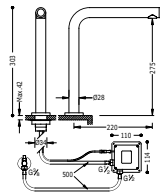

Cucina elettronica 1 acqua TOUCH-TRES

Sistema sensibile al tatto. Senza premere.

TOUCH-TRES 1 water electronic tap

Sensitive system to the touch. No press.

Elektronická dřevěvá kuchyňská baterie na 1 vodu
TOUCH-TRES

Dotyková. Pouze na dotek (NESMÍ se stisknout)



Cr 1.61.445

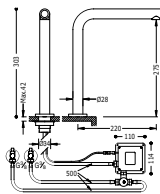

Cucina elettronica miscelatore TOUCH-TRES

Sistema sensibile al tatto. Senza premere. **NOTA:** include un rubinetto miscelatore a due acque con tubi flessibili (per ref: 1.92.507.30).

TOUCH-TRES electronic mixer tap

Sensitive system to the touch. No press. **NOTE:** Includes a hot and cold mixer tap with flexible pipes (for Nr.: 1.92.507.30).

Elektronická dřevěvá kuchyňská baterie směšná
TOUCH-TRES

Dotyková. Pouze na dotek (NESMÍ se stisknout). **POZNÁMKA:** Obsahuje směšnou baterii pro teplou i studenou vodu s ohebnými hadicemi (Kód: 1.92.507.30).



Cr 1.61.446

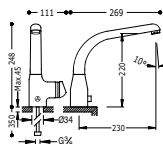

Monocomando cucina elettronico

Miscelatore

Electronic sink mixer

Cold and warm water

Jednopáková elektronická kuchyňská baterie

Směšovací baterie



Cr 1.92.445

Acqua filtrata senza cloro in un solo rubinetto cucina. La soluzione piú efficace e facile per avere acqua senza cloro in casa senza dover comprare e trasportare bottiglie di acqua.

Second gli Studio realizzati, l'acqua osmotizzata, é eccessivamente bassa in minerali, ragione per cui non é raccomandabile per il consumo giornaliero.

IL FILTRO ANTICLORO di TRES invece assicura un indice basso in Cloro, eliminando perciò il cattivo sapore dell'acqua, però rispettando le proprietà minerali dell'acqua della rete.

Filtering water without chlorine in just one tap into the kitchen. The most efficient and easy solution to have in our house water without chlorine without having to buy and transport bottles of water.

According to the investigations carry out, the osmotized water is excessively lower in minerals, so it is not recommendable its daily consumption.

The anti-chlorine TRES filter assure a low Chlorine index, taking out the nasty water taste but respecting the minerals property of mains water.

Kuchyňský kohoutek s filtrovanou vodou bez chlóru. Nejúčinnější a jednoduchý způsob získání nechlorované vody bez nutnosti zakoupení a dopravy lahvíček.

Z provedených výzkumů vyplývá, že osmotická voda je příliš ochuzena o minerály, což znamená, že není doporučována k běžnému užívání.

ANTICHLOROVÝ FILTR od společnosti TRES zaručuje nízký obsah chlóru a eliminuje zápach vody při zachování minerálních vlastností vody ze sítě.



La chiusura è situata esattamente all'uscita dell'acqua, eliminando il contatto tra essa e l'aria ed evitando in questo modo la sua contaminazione.

The lever is located at the exact point where the water comes out, eliminating contact between the water and the air and preventing contamination.

Uzávěr je umístěn přímo u výstupu vody, čímž je zamezeno kontaktu vody se vzduchem a tím pádem její kontaminace.





CUCINA INDUSTRIALE / INDUSTRIAL KITCHEN TAPS / DŘEZOVÁ BATERIE PRŮMYSLOVÁ

Ref. / Nr. / Kód:

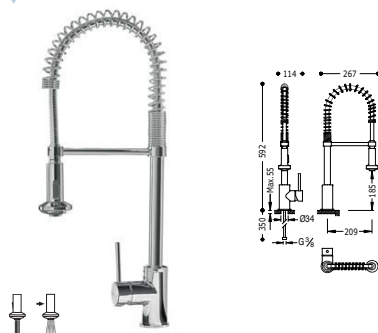

Monocomando lavello verticale MAX-TRES
doccia di due posizioni

Single lever single hole sink mixer
shower with two positions

Jednopáková dřezová kuchyňská baterie MAX-TRES
Dvoupolohová sprška



Cr 1.30.493

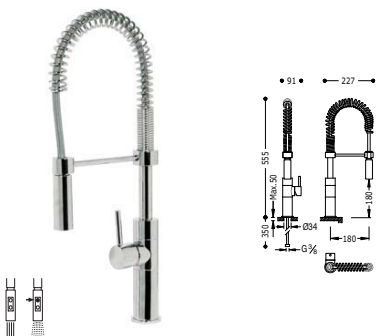

Monocomando lavello verticale
doccia di due posizioni

Single lever single hole sink mixer
shower with two positions

Jednopáková dřezová kuchyňská baterie
Dvoupolohová sprška



Cr 1.30.485

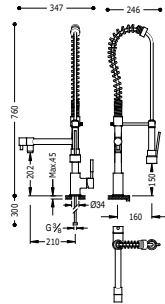

Monocomando lavello verticale
Single lever single hole sink mixer
Jednopáková dřezová kuchyňská baterie

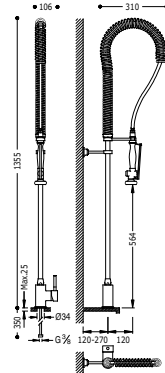
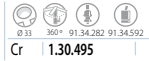

Monocomando lavello verticale
Single lever single hole sink mixer
Jednopáková dřezová kuchyňská baterie

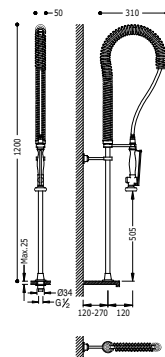

Monocomando lavello verticale
Single lever single hole sink mixer
Dřezová kuchyňská baterie



Rubinetto a pedale
Pedal-operated tap
Nášlapná baterie

Miscelatore. Montaggio a terra con flessibili. La température de l'eau augmente à mesure que vous appuyez sur la pédale. / Cold and warm water. Floor mounting with supply pipes. Press the pedal to progressively raise the water temperature. / Se směšovačem. Montáž k podlaze pomocí hadiček. Stlačením pedálu se progresivně zvyšuje teplota vody.



Monocomando incasso doccia
Single lever concealed shower mixer
Podomítková stojánková sprchová baterie

Cr | 1.12.370

Cr | 1.34.161

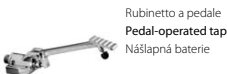

Rubinetto a pedale
Pedal-operated tap
Nášlapná baterie

Un'acqua. Montaggio a terra con flessibili. / Only cold water. Floor mounting with supply pipes. / Pro studenou vodu (nebo vstupně smíšenou). Montáž k podlaze pomocí hadiček.



Monocomando incasso doccia
Single lever concealed shower mixer
Podomítková sprchová baterie

Cr | 1.12.360

Cr | 017.177.12



CUCINA A PARETE / WALL KITCHEN / NÁSTĚNNÉ KUCHYŇSKÉ BATERIE

Ref. / Nr. / Kód:

Monomando a muro CUADRO-TRES
Single lever wall washbasin mixer CUADRO-TRES
Jednopáková nástěnná baterie CUADRO-TRES

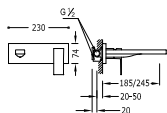

91.30.190 (185 mm.)

Cr 006.200.03

91.30.190 (245 mm.)

Cr 006.200.04

Monomando a muro LOFT-TRES
Single lever wall mixer LOFT-TRES
Jednopáková nástěnná baterie LOFT-TRES

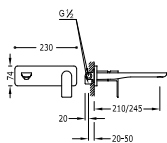

91.30.190 (210 mm.)

Cr 200.200.03

91.30.190 (245 mm.)

Cr 200.200.02

Monomando a muro CLASS-TRES
Single lever wall washbasin mixer CLASS-TRES
Jednopáková nástěnná baterie CLASS-TRES

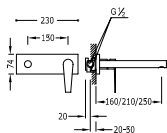

91.30.190 (210 mm.)

Cr 205.200.41

91.30.190 (250 mm.)

Cr 205.200.01

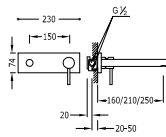

Monomando a muro MAX-TRES
Single lever wall mixer MAX-TRES
Jednopáková nástěnná baterie MAX-TRES

91.34.592 (210 mm.)
Cr | **062.200.02**

91.34.592 (250 mm.)
Cr | **1.62.200**

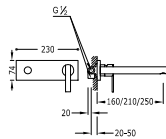

Monomando a muro LEX-TRES
Single lever wall mixer LEX-TRES
Jednopáková nástěnná baterie LEX-TRES

91.34.592 (210 mm.)
Cr | **081.200.21**

91.34.592 (250 mm.)
Cr | **1.81.200**

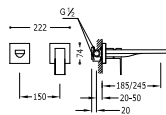

Monomando a muro CUADRO-TRES
Single lever wall washbasin mixer CUADRO-TRES
Jednopáková nástěnná baterie CUADRO-TRES

91.30.190 (185 mm.)
Cr | **006.200.12**

91.30.190 (245 mm.)
Cr | **006.200.11**

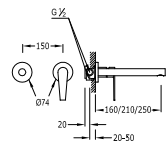

Monomando a muro CLASS-TRES
Single lever wall washbasin mixer CLASS-TRES
Jednopáková nástěnná baterie CLASS-TRES

91.30.190 (210 mm.)
Cr | **205.200.71**

91.30.190 (250 mm.)
Cr | **205.200.02**

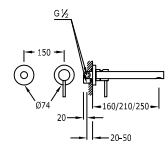

Monomando a muro MAX-TRES
Single lever wall washbasin mixer MAX-TRES
Jednopáková nástěnná baterie MAX-TRES

91.30.190 (210 mm.)
Cr | **062.200.71**

91.30.190 (250 mm.)
Cr | **062.200.03**

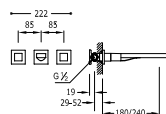

Monoblocco a muro CUADRO-TRES
Single hole wall mixer CUADRO-TRES
Nástěnná dvoupáková umyvadlová baterie CUADRO-TRES

91.34.282 (180 mm.)
Cr | **008.153.01**

91.34.282 (240 mm.)
Cr | **008.154.01**



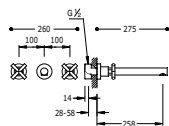

Monoblocco a muro BIMAX-TRES

Single hole wall mixer BIMAX-TRES

Nástěnná dvoupáková umyvadlová baterie BIMAX-TRES



Cr 1.63.151

(250 mm.)



CUCINA DOPPIO COMANDO / DUAL-CONTROL KITCHEN TAPS / DŘEZOVÉ BATERIE S DVOUPÁKOVÝM MECHANISMEM

Ref. / Nr. / Kód:

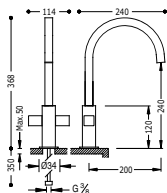

Monoblocco lavello verticale CUADRO-TRES
Canna tubo 22x22 mm.

Single hole sink mixer CUADRO-TRES
Tube spout 22x22 mm.

Dvoupáková dřezová kuchyňská baterie CUADRO-TRES
ramínko 22x22 mm



Cr 1.08.497

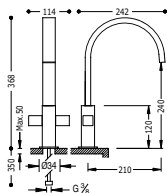

Monoblocco lavello verticale CUADRO-TRES
Canna tubo 35x15 mm. Aeratore rettangolare

Single hole sink mixer CUADRO-TRES
Tube spout 35x15 mm. Rectangular Aeratore

Dvoupáková dřezová kuchyňská baterie CUADRO-TRES
ramínko 35x15 mm se skrytým obdélníkovým perlátorem



Cr 1.08.498

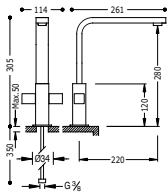

Monoblocco lavello verticale CUADRO-TRES
Canna tubo 35x15 mm.

Single hole sink mixer CUADRO-TRES
Tube spout 35x15 mm.

Dvoupáková dřezová kuchyňská baterie CUADRO-TRES
ramínko 35x15 mm



Cr 1.08.496

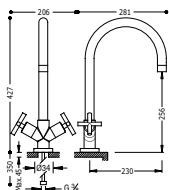

Monoblocco lavello verticale BIMAX-TRES

Single hole sink mixer BIMAX-TRES

Dvoupáková dřezová kuchyňská baterie BIMAX-TRES



Cr | 1.63.333

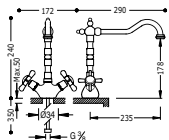

Monoblocco lavello verticale RETRO-TRES

Single hole sink mixer RETRO-TRES

Dvoupáková dřezová kuchyňská baterie RETRO-TRES



Cr | 1.24.342.61

Lv | 5.24.342.01.61

Co | 5.24.342.02.61

Ac | 5.24.342.03.61

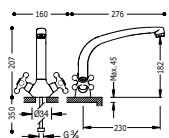

Monoblocco lavello verticale CLASIC-TRES

Single hole sink mixer CLASIC-TRES

Dvoupáková dřezová kuchyňská baterie CLASIC-TRES



Cr | 1.32.335

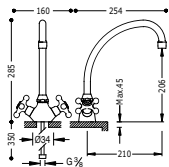

Monoblocco lavello verticale CLASIC-TRES

Single hole sink mixer CLASIC-TRES

Dvoupáková dřezová kuchyňská baterie CLASIC-TRES



Cr | 1.32.342

Lv | 5.32.342.01

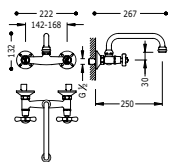

Gruppo lavello parete RETRO-TRES

Distanza da parete di 250 mm.

Wall sink mixer RETRO-TRES

Distance from wall 250 mm.

Nástěnný dřezový kuchyňský set RETRO-TRES

vzdálenost od zdi 250 mm



Cr | 024.215.01

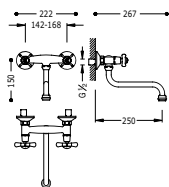

Gruppo lavello parete RETRO-TRES

Distanza da parete di 250 mm.

Wall sink mixer RETRO-TRES

Distance from wall 250 mm.

Nástěnný dřezový kuchyňský set RETRO-TRES

vzdálenost od zdi 250 mm



Cr | 024.310.01

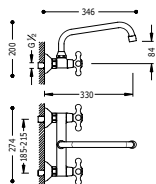

Gruppo lavello parete CLASIC-TRES

Distanza da parete di 330 mm.

Wall sink mixer CLASIC-TRES

Distance from wall 330 mm.

Nástěnný dřezový kuchyňský set CLASIC-TRES

vzdálenost od zdi 330 mm



360° 185-215

Cr | 1.32.416







TEMPORIZZATE / ELETTRONICHE FITTED WITH TIMERS / ELECTRONIC S ČASOVAČEM / ELEKTRONICKÉ



Lavabi
Basin mixer taps
Koupelňová baterie
546



Gruppo da urinatoio
Urinal tap
Baterie pro pisoár
550



Gruppo doccia
Shower tap
Sprchová baterie
551



Cucina
Kitchen
Kuchyně
553

www.tresgriferia.com



**RICAMBI SU
SPARE PARTS AT
NÁHRADNÍ DÍLY NA**
www.tresgriferia.com



RUBINETTO TEMPORIZZATO PER LAVABO / SINK TIMER TAP / UMYVADLOVÁ BATERIE S ČASOVAČEM

Ref. / Nr. / Kód:

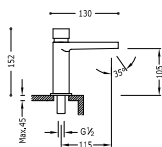

Lavabo temporizzato 1 acqua
Chiusura automatica a 6 sec.

Single water temperature timer sink tap
Automatic shut-off at 6 seconds

Umyvadlová baterie pro jednu vodu s časovým vypínačem
Automatické uzavření po uplynutí 6 s

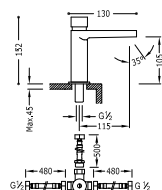

Lavabo temporizzato miscelatore
Chiusura automatica a 6 sec. *NOTA: include un rubinetto miscelatore a due acque con tubi flessibili (per ref.: 1.92.507.30).*

Mixer timer sink tap
Automatic shut-off at 6 seconds. *NOTE: Includes a hot and cold mixer tap with flexible pipes (for nr.: 1.92.507.30).*

Srněšovaci umyvadlová baterie
Automatické uzavření po uplynutí 6 s. *POZNÁMKA: Obsahuje směšnou baterii pro teplou i studenou vodu s ohebnými hadicemi (Kód: 1.92.507.30).*



N

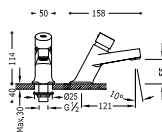

Lavabo temporizzato 1 acqua
Chiusura automatica a 6 sec.

Single water temperature timer sink tap
Automatic shut-off at 6 seconds

Umyvadlová baterie pro jednu vodu s časovým vypínačem
Automatické uzavření po uplynutí 6 s



N

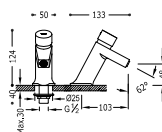

Lavabo temporizzato 1 acqua
Chiusura automatica a 6 sec.

Single water temperature timer sink tap
Automatic shut-off at 6 seconds

Umyvadlová baterie pro jednu vodu s časovým vypínačem
Automatické uzavření po uplynutí 6 s

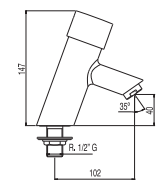

Lavabo temporizzato 1 acqua
Chiusura automatica a 6 sec. Flusso 6,5 l/min.

Single water temperature timer sink tap
Automatic shut-off at 6 seconds. Flow 6.5 l/min.

Umyvadlová baterie pro jednu vodu s časovým vypínačem
Automatické uzavření po uplynutí 6 s. Průtok 6,5 l/min.



Gruppo lavabo ad appoggio
entrata tubo 10 x 12. Chiusura automatica a 15 sec. Flusso 6,5 l/min.

Tap from framemounted washbasin
10x12. Automatic shut-off at 15 seconds. Flow 6.5 l/min.

Umyvadlová baterie pro desku
vstup trubky 10x12. Automatické uzavření po uplynutí 15 s. Průtok 6,5 l/min.



N

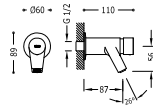

Gruppo lavabo a muro
entrata 1/2" G. Maschio. Chiusura automatica a 6 sec. Flusso 6,5 l/
min.

Tap for wall, washbasin
1/2" G. Automatic shut-off at 6 seconds. Flow 6.5 l/min.

Nástěnná umyvadlová baterie
vnější závit 1/2" G. Automatické uzavření po uplynutí 6 s. Průtok
6,5 l/min.



299.396.01 6"
Cr 012.100.02

N

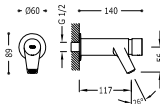

Gruppo lavabo a muro
entrata 1/2" G. Maschio. Chiusura automatica a 6 sec. Flusso 6,5 l/
min.

Tap for wall, washbasin
1/2" G. Automatic shut-off at 6 seconds. Flow 6.5 l/min.

Nástěnná umyvadlová baterie
vnější závit 1/2" G. Automatické uzavření po uplynutí 6 s. Průtok
6,5 l/min.



299.396.01 6"
Cr 012.100.03

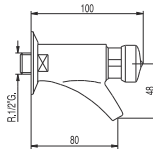

Gruppo lavabo a muro
entrata 1/2" G. Maschio. Chiusura automatica a 15 sec. Flusso 6,5 l/
min.

Tap for wall, washbasin
1/2" G. Automatic shut-off at 15 seconds. Flow 6.5 l/min.

Nástěnná umyvadlová baterie
vnější závit 1/2" G. Automatické uzavření po uplynutí 15 s. Průtok
6,5 l/min.



Cr 1.12.100



RUBINETTO ELETTRONICO PER LAVABO / SINK ELECTRONIC TAP / ELEKTRONICKÁ UMYVADLOVÁ BATERIE

Ref. / Nr. / Kód:

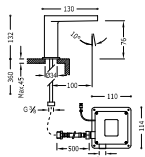

Lavabo elettronico 1 acqua TOUCH-TRES

Azionamento tramite sensore a infrarossi

1 water electronic tap

Operated by an infrared sensor

Elektronická baterie na 1 vodu

Spouštěna snímačem infračerveného záření



Cr 205.603.01

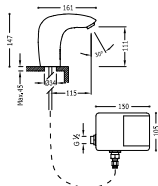

Lavabo elettronico 1 acqua

Azionamento tramite sensore a infrarossi

1 water electronic tap

Operated by an infrared sensor

Elektronická baterie na 1 vodu

spouštěno snímačem infračerveného záření



Cr 1.92.606.03

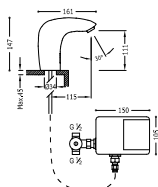

Lavabo elettronico miscelatore

Azionamento tramite sensore a infrarossi.

Electronic mixer tap

Operated by an infrared sensor.

Elektronická baterie směšná

spouštěno snímačem infračerveného záření.



Cr 1.92.906.03

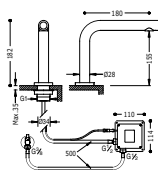

Lavabo elettronico 1 acqua TOUCH-TRES

Sistema sensibile al tatto. Senza premere.

TOUCH-TRES 1 water electronic tap

Sensitive system to the touch. No press.

Elektronická baterie na 1 vodu TOUCH-TRES

Dotyková. Pouze na dotek (NESMÍ se stisknout)



Cr 061.447.01

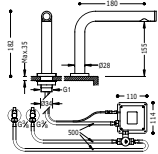

Lavabo elettronico miscelatore TOUCH-TRES

Sistema sensibile al tatto. Senza premere. NOTA: include un rubinetto miscelatore a due acque con tubi flessibili (per ref.: 1.92.507.30).

TOUCH-TRES electronic mixer tap

Sensitive system to the touch. No press. NOTE: Includes a hot and cold mixer tap with flexible pipes (for Nr.: 1.92.507.30).

Směšovací elektronická baterie TOUCH-TRES

Dotyková. Pouze na dotek (NESMÍ se stisknout). POZNÁMKA: Obsahuje směšnou baterii pro teplou i studenou vodu s ohebnými hadicemi (Kód: 1.92.507.30).



Cr 061.448.01

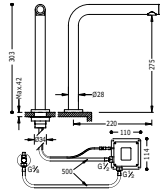

Lavabo elettronico 1 acqua TOUCH-TRES
Sistema sensibile al tatto. Senza premere.

TOUCH-TRES 1 water electronic tap
Sensitive system to the touch. No press.

Elektronická baterie na 1 vodu TOUCH-TRES
Dotyková. Pouze na dotek (NESMÍ se stisknout)



Cr | 1.61.445

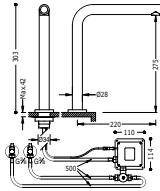

Lavabo elettronico miscelatore TOUCH-TRES
Sistema sensibile al tatto. Senza premere. NOTA: include un rubinetto miscelatore a due acque con tubi flessibili (per ref.: 1.92.507.30).

TOUCH-TRES electronic mixer tap
Sensitive system to the touch. No press. NOTE: Includes a hot and cold mixer tap with flexible pipes (for Nr.: 1.92.507.30).

Elektronická baterie směšná TOUCH-TRES
Dotyková. Pouze na dotek (NESMÍ se stisknout). POZNÁMKA: Obsahuje směšnou baterii pro teplou i studenou vodu s ohebnými hadicemi (Kód: 1.92.507.30).

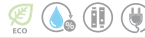

Cr | 1.61.446

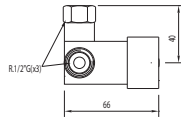

Miscelatore due acque CON TUBI FLESSIBILI
(TRESTRONIC, TOUCH-TRES, TEMPO-TRES)

Two-water mixer WITH FLEXIBLE PIPES
(TRESTRONIC, TOUCH-TRES, TEMPO-TRES)

Směšovač na dvě vody S FLEXIBILNÍMI TRUBKAMI
pro umyvadlové baterie TRESTRONIC, TOUCH-TRES a TEMPO-TRES

Cr | 1.92.507.30

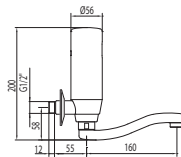

Lavabo elettronico 1 acqua

1 water electronic tap

Elektronická baterie na 1 vodu



Cr | 092.171.01



RUBINETTO TEMPORIZZATO PER URINATOIO / URINAL TIMER TAP / PISOÁROVÁ BATERIE S ČASOVAČEM

Ref./Nr./Kód:

N

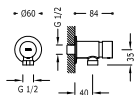

Gruppo da urinatoio
Urinal tap
Baterie pro pisoár



299.396.01

Cr 012.200.02

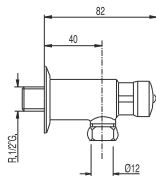

Gruppo da urinatoio
entrata posteriore. Madrevite maschio 1/2" G. uscita con filettatura e
giuntura per tubo 10x12. Chiusura automatica a 15 sec. Flusso 16 l/min.

Urinal tap
Outlet with nut and joint for 10x12 pipe. Flow 16 l/min.

Baterie pro pisoár
zadní vstup, vnější závit 1/2" G. Výstup s maticí a těsněním pro trubku
10x12. Průtok 16 l/min.



Cr 1.12.200

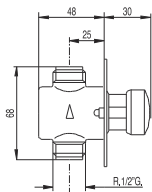

Gruppo da urinatoio
entrata 1/2" G. Maschio

Urinal tap
1/2" G.

Baterie pro pisoár podomítková
vnější závit 1/2" G.



Cr 012.208.01

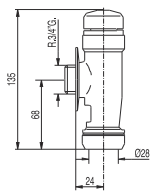

Fluxor per water
entrata filettatura maschio 3/4" G. Uscita per tubi 26x28 1,5 l/m.

Toilet flush button

3/4" G. thread plug cock intel. Outlet for 26x28 pipe. Flow 1,5 l/min.

Splachovač pro WC

vstup vnější závit 3/4" G. Výstup pro trubku 26x28. Průtok 1,5 l/min.



Cr 1.12.205

RUBINETTO ELETTRONICO PER URINATOIO / URINAL ELECTRONIC TAP / ELEKTRONICKÁ PISOÁROVÁ BATERIE

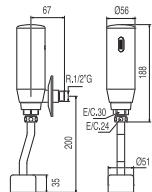

Rubinetto scarico elettronico per urinatorio
con due tubi adattabili a urinatoio

Electronic view urinary tap
with two adaptable tubs to urinary

Elektronická nekrytá pisoárová baterie
s dvěma trubkami přizpůsobitelnými na pisoár



Cr 1.12.206

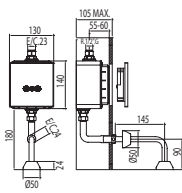

Rubinetto scarico elettronico per urinatorio

Electronic concealed urinary tap

Elektronická vestavěná baterie pro pisoár



Cr 012.207.01

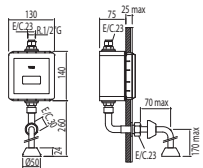

Rubinetto scarico elettronico per urinatorio
Electronic concealed urinary tap
Elektronická vestavná baterie pro pisoár



Cr | 1.12.207

RUBINETTO TEMPORIZZATO PER DOCCIA / SHOWER TIMER TAP / SPRCHOVÁ BATERIE S ČASOVAČEM

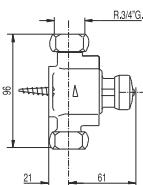

Gruppo doccia
alimentazione esteriore per parte inferiore entrata e uscita con
filettatura e giunto per tubo 13x15 16 l/m.

Shower tap
outer feeding by means of lower part. Intel and outlet with nut and
joint for 13x15 pipe. Automatic shut-off at 15 seconds. Flow 16 l/
min.

Sprchová baterie
vnější přítok spodem, vstup a výstup s maticí a těsněním pro trubici
13x15. Automatické uzavření po uplynutí 15 s. Průtok 16 l/min.



Cr | 1.12.167

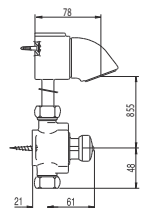

Set doccia rubinetto piu vaporizzatore
16 l/m.

Shower unit
exterior feed from the bottom, with nut and joint for a 13x15 pipe and
automatic flow regulator incorporated: 16 l/min.

Sprchová souprava
vnější napájení přes spodní část, s maticí a těsněním pro trubici
13x15 a zabudovaný automatický regulátor průtoku: 16 l/m



Cr | 1.12.161

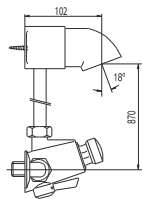

Set miscelatore per doccia
entrata opposta con raccordi estensibili. Regolatore automatico
di portata incorporato nel vaporizzatore. Valvola antiritorno in
entrata. 16 l/m.

Mixer assembly for shower
Opposing inlets with extendable fittings. Automatic flow regulator
incorporated in the sprinkler. Anti-return valves at the inlets. Flow
16 l/min.

Směšovací souprava pro sprchu
protilehlé vstupy s nastavitelnými převlečnými maticemi.
Automatická regulace průtoku zabudovaná do kropítka. U vstupů
ventily proti zpětnému toku vody. 16 l/min



Cr | 1.12.163

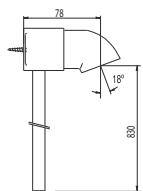

Soffione piu tubo
6 l/m.

Tube with shower sprayer
Flow 6 l/min.

Kropítko + trubka
Průtok 6 l/min.

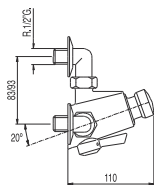

Cr | 1.12.161.50

Gruppo miscelatore per doccia

Entrata opposta e uscita verticale Equipaggiato con 3 raccordi estensibili 16 l/m.

Mixer tap for shower
Flow 16 l/min.

Sprchová směšovací baterie protilehlé vstupy a svislý výstup. Vybavena 3 nastavitelnými převlečnými maticemi. U vstupu ventily proti zpětnému toku vody. Průtok 16 l/min.

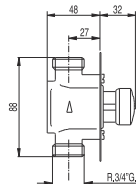

Cr | 1.12.162

Gruppo doccia ad incasso

Entrata e uscita con madrevite maschio 3/4" G. 20 l/m.

Shower taps

For recessing, intel and outlet with 3/4" G thread plug cock. Flow 20 l/min.

Sprchová baterie podomítková vstup a výstup s vnějším závitem 3/4" G. Průtok 20 l/min.

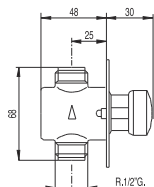

Cr | 1.12.178

Gruppo doccia ad incasso

Entrata e uscita con madrevite maschio 1/2" G. 16 l/m.

Shower taps

For recessing, intel and outlet with 1/2" G thread plug cock. Flow 16 l/min.

Sprchová baterie podomítková vstup a výstup s vnějším závitem 1/2" G. Průtok 16 l/min.



Cr | 1.12.177

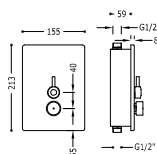

Gruppo miscelatore per doccia con 2 ingressi d'acqua

Mixer tap for shower with 2 water inlets

Sprchová směšovací baterie, protilehlé vstupy a svislý výstup. se 2 vstupy vody

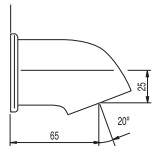

Cr | 012.179.01

Soffione antivandalico

6 l/m.

Shower sprayer

with automatic flow regulator 6 l/min.

Kropítko odolné vůči vandalizaci, s automatickou regulací průtoku s automatickým regulátorem průtoku 6 l/min.

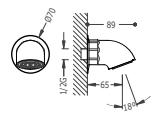

Cr | 1.34.168.03

Soffione per doccia

R 1/2" G.

Shower sprayer

with automatic flow regulator. R 1/2" G.

Sprchové kropítko, s automatickou regulací průtoku s automatickým regulátorem průtoku. Závit 1/2" G.



Cr | 1.34.167.03

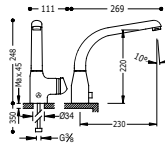

Monocomando cucina elettronico
Miscelatore

Electronic sink mixer
Cold and warm water

Jednopáková elektronická kuchyňská baterie
Směšovací baterie



300* 91.34.290

Cr 1.92.445

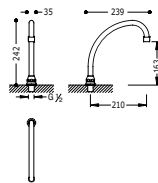

Tubo lavello
con collegamento

Tube spout
with link

Dřevové ramínko
se spojkou



Cr 1.12.441

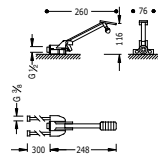

Rubinetto a pedale

Miscelatore. Montaggio a terra con flessibili. La température de l'eau augmente à mesure que vous appuyez sur la pédale.

Pedal-operated tap

Cold and warm water. Floor mounting with supply pipes. Press the pedal to progressively raise the water temperature.

Nášlapná baterie

Se směšovačem. Montáž k podlaze pomocí hadiček. Stlačením pedálu se progresivně zvyšuje teplota vody.

Cr 1.12.370

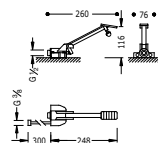

Rubinetto a pedale

Un'acqua. Montaggio a terra con flessibili

Pedal-operated tap

Only cold water. Floor mounting with supply pipes

Nášlapná baterie

Pro studenou vodu (nebo vstupně smíšenou). Montáž k podlaze pomocí hadiček

Cr 1.12.360





RUBINETTERIA SPECIALE SPECIAL TAPWARE SPECIÁLNÍ BATERIE



Bidet
Bidets
Bidety
556



Rubineria medicale
Medical fixtures
Lékařská zařízení
560



Parrucchieri
Hair salon fixtures
Kadeřnictví
561



Cucina
Kitchen
Kuchyně
561



Giardino - Piscina
Garden - Pool
Zahrada - Bazén
562



Vino
Wine
Vino
563

www.tresgriferia.com



RICAMBI SU
SPARE PARTS AT
NÁHRADNÍ DÍLY NA
www.tresgriferia.com



SOSTITUIRE IL BIDET E APPROFITTARE DELLO SPAZIO REPLACES THE BIDET AND MAKES GOOD USE OF SPACE NAHRADĚTE BIDET A VYUŽIJTE PROSTORU

Approfittate dello spazio del bagno sostituendo il bidet tradizionale con un rubinetto che utilizza il recipiente del water. / **Makes the most of the bathroom space, as it replaces the traditional bidet with a tap that takes advantage of the WC fixture.** / Využijte prostoru v koupelně tím, že tradiční bidet nahradíte baterií s využitím mísy WC.

Installazione semplice in poco spazio. / **Easy to install, requires little space.** / Snadná instalace na malém prostoru.

Il sistema protec-tres® consente di scegliere la posizione massima di apertura della leva per l'acqua calda, evitando possibili bruciate. / **The protec-tres® system lets you choose the maximum opening position of the hot water lever, preventing scalding.** / Systém protec-tres® umožňuje používat pozici pro maximální otevření páky u teplé vody a zabraňuje přítomnému popálení.



SOLUZIONE SENZA LAVORI
SOLUTION THAT DOES NOT REQUIRE WORKS
ŘEŠENÍ BEZ STAVEBNÍCH PRACÍ



- Monocomando speciale da lavabo con un'uscita specifica per la doccia/bidet.
- Installazione semplice utilizzando la presa d'acqua condivisa con il monocomando del lavabo.
- Doccia a mano con chiusura e valvola antiritorno. Tubo flessibile SATIN.
- Special bathroom mixer tap with a dedicated shower/bidet outlet.
- Easy to install using the water outlet shared with the sink mixer tap.
- Shower head with a closing system and check valve. SATIN hose.
- Speciální jednopáková umyvadlová baterie s jedním specifickým výstupem pro sprchu/bidet.
- Snadná instalace s využitím společného přívodu vody pro jednopákovou umyvadlovou baterii.
- Ruční sprcha s uzávěrem a zpětným ventilem. Hadice SATIN.

SOLUZIONE CON LAVORI
SOLUTION THAT DOES REQUIRE WORKS
ŘEŠENÍ SE STAVEBNÍMI PRACEMI



- Monocomando miscelatore incassato con supporto doccia/bidet integrato.
- Design quadrato o rotondo, con diversi modelli di manopola. Ciascun modello dispone dell'opzione per pareti di cartongesso.
- Il supporto doccia a mano può stare a sinistra o a destra, intercambiabile.
- La doccia a mano è di ottone con raccordo limitatore 5 l/min. Con sistema antigocciolamento. Tubo flessibile SATIN.
- È possibile agganciare un accessorio per asciugamani disponibile in design quadrato e rotondo (in vendita separatamente).
- Built-in mixer tap with integrated shower/bidet support.
- Square or round design with different handle models. Each model features an option for plasterboard walls.
- The shower head support can be positioned on the left or right and changed from one side to the other.
- The shower head is made from brass with a 5 L/min limiter fitting. Anti-drip system. SATIN hose.
- Towel holder can be attached to the square and round design (sold separately).

- Vestavěná jednopáková směšovací baterie s integrovaným držákem sprchy/bidetu.
- Hranatý či kulatý design, s různými modely páčky. U všech modelů je k dispozici možnost pro stěny ze sádrokartonu.
- Držák ruční sprchy lze umístit nalevo nebo napravo, je zaměnitelný.
- Ruční sprcha je mosazná, s omezovacím hrdlem 5 l/min. Se systémem proti kapání. Hadice SATIN.
- Lze sladit s příslušenstvím pro ručníky, které je k dispozici v hranatém a kulatém designu (prodává se zvlášť).

BIDET / BIDETS / BIDETY

Ref. / Nr. / Kód:

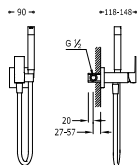

Monocomando ad incasso per bidé WC
Supporto a destra o a sinistra, intercambiabile. Flesso satinato.
* Opzione Cartongesso

Concealed single lever bidet/toilets
Left or right support, interchangeable. Sateen hose. * Optie gips

Jednopáková podomítková baterie pro bidet WC
Vyměnitelný držák zprava či zleva. Sprchová mosazná baterie s omezovacím hrdlem 5 l/m. Systém proti kapání a flexi hadice SATIN.
* Možnost pro sádkartonové panely



91.30.190

Cr 006.123.01
Cr 006.123.02*

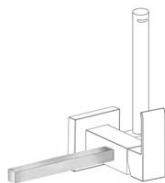

Accessori portasciugamani
180 mm. (per ref.: 006.123.01, 006.123.02). NOTA: Supporto a destra o a sinistra, intercambiabile.

Accessory towel racks
180 mm. (for Nr.: 006.123.01, 006.123.02). NOTE: Left or right support, interchangeable.

Příslušenství držák na ručníky
180 mm. (Kód: 006.123.01, 006.123.02). POZNÁMKA: Právý nebo levý podstavec, vyměnitelný.

Cr 034.124.02

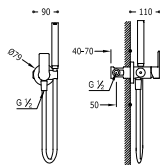

Monocomando ad incasso per bidé WC
Supporto a destra o a sinistra, intercambiabile. Flesso satinato.
* Opzione Cartongesso

Concealed single lever bidet/toilets
Left or right support, interchangeable. Sateen hose. * Optie gips

Jednopáková podomítková baterie pro bidet WC
Vyměnitelný držák zprava či zleva. Sprchová mosazná baterie s omezovacím hrdlem 5 l/m. Systém proti kapání a flexi hadice SATIN.
* Možnost pro sádkartonové panely



91.34.591

Cr 205.223.01
Cr 205.222.01*

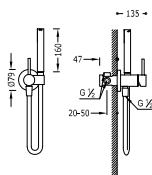

Monocomando ad incasso per bidé WC
Supporto a destra o a sinistra, intercambiabile. Flesso satinato.
* Opzione Cartongesso

Concealed single lever bidet/toilets
Left or right support, interchangeable. Sateen hose. * Optie gips

Jednopáková podomítková baterie pro bidet WC
Vyměnitelný držák zprava či zleva. Sprchová mosazná baterie s omezovacím hrdlem 5 l/m. Systém proti kapání a flexi hadice SATIN.
* Možnost pro sádkartonové panely



91.34.591

Cr 1.34.123
Cr 1.34.122*

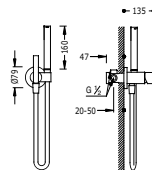

Monocomando ad incasso per bidé WC
Supporto a destra o a sinistra, intercambiabile. Flesso satinato.
* Opzione Cartongesso

Concealed single lever bidet/toilets
Left or right support, interchangeable. Sateen hose. * Optie gips

Jednopáková podomítková baterie pro bidet WC
Vyměnitelný držák zprava či zleva. Sprchová mosazná baterie s omezovacím hrdlem 5 l/m. Systém proti kapání a flexi hadice SATIN.
* Možnost pro sádkartonové panely



91.34.591

Cr 1.81.223
Cr 1.81.222*



Accessori portasciugamani
180 mm. (per ref.: 1.34.122, 1.34.123, 1.81.122, 1.81.123, 205.222.01, 205.223.01). NOTA: Supporto a destra o a sinistra, intercambiabile.

Accessory towel racks
180 mm. (for Nr.: 1.34.122, 1.34.123, 1.81.122, 1.81.123, 205.222.01, 205.223.01). NOTE: Left or right support, interchangeable.

Příslušenství držák na ručníky
180 mm. (Kód: 1.34.122, 1.34.123, 1.81.122, 1.81.123, 205.222.01, 205.223.01). POZNÁMKA: Právý nebo levý podstavec, vyměnitelný.

Cr 034.124.01

RUBINETTERIA MEDICALE / MEDICAL FIXTURES / LÉKAŘSKÁ ZAŘÍZENÍ

Ref. / Nr. / Kód:

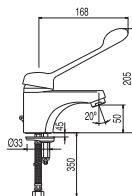

Monocomando lavabo

Leva medicale

Single lever washbasin mixer
With clinic lever

Jednopáková umyvadlová baterie
lité ramínko



Cr 1.70.103.02.11

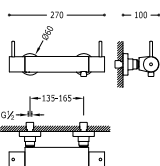

Doccia termostatica

Doccetta anticalcare (299.631.03) con supporto orientabile.
Flessibile satin (91.34.609.15). Indicato per persone con disabilità

Wall thermostatic shower mixer
Anti-limescale hand shower (299.631.03) with directable support.
Shower hose satin (91.34.609.15). Suitable for persons with physical disabilities.

Termostatická sprchová baterie

Ruční sprcha s nastavitelným držákem (299.631.03), proti usaz. vod. kamene a flexi hadice SATIN (91.34.609.15). Určeno pro osoby s fyzickým handicapem



Cr 090.264.01

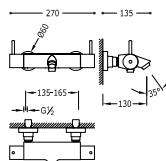

Vasca-Doccia termostatica

Doccetta anticalcare (299.631.03) con supporto orientabile.
Flessibile satin (91.34.609). Indicato per persone con disabilità fisiche

Wall thermostatic shower mixer

Anti-limescale hand shower (299.631.03) with directable support.
Shower hose satin (91.34.609). Suitable for persons with physical disabilities.

Termostatická baterie pro vanu-sprchu

Ruční sprcha s nastavitelným držákem (299.631.03), proti usaz. vod. kamene a flexi hadice SATIN (91.34.609). Určeno pro osoby s fyzickým handicapem



Cr 090.274.01



Cr 090.974.01

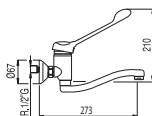

Monocomando a muro

Leva medicale

Single lever wall sink mixer
With clinic lever

Jednopáková dřezová baterie nástěnná
s lékařskou páčkou



Cr 1.72.318.11

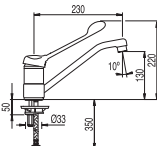

Monocomando a muro

Leva medicale

Single lever single hole sink mixer
With clinic lever

Jednopáková dřezová baterie svislá
s lékařskou páčkou



Cr 1.72.333.11

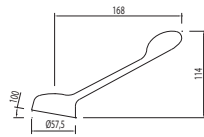

Leva medicale
(per ref.: ECO-TRES, MONOTRES 2000)

Clinic lever
(for Nr.: ECO-TRES, MONOTRES 2000)

Lékařská páčka jednopákové baterie
(pro ref. č.: ECO-TRES, MONOTRES 2000)



Cr | 91.34.011 |

PARRUCCHIERI / HAIR SALON FIXTURES / KADEŘNICTVÍ

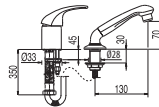

Monocomando parrucchieri
Hairdresser's shop
Jednopáková baterie pro kadeřnictví



91.34.288
Cr | 1.72.450 |

CUCINA / KITCHEN / KUCHYNĚ

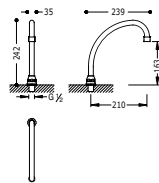

Tubo lavello
Tube spout
Dřezové ramínko, se spojkou



Cr | 1.12.441 |

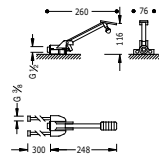

Gruppo a pedale
Miscelatore. Montaggio a terra con flessibili. La temperatura de l'eau augmente à mesure que vous appuyez sur la pédale.
Pedal water tap
Cold and warm water. Floor mounting with supply pipes. Press the pedal to progressively raise the water temperature.
Nášlapná baterie
Se směšovačem. Montáž k podlaze pomocí hadiček. Stlačením pedálu se progresivně zvyšuje teplota vody.

Cr | 1.12.370 |

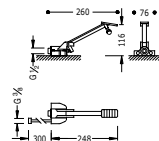

Gruppo a pedale
Un'acqua. Montaggio a terra con flessibili
Pedal water tap
Only cold water. Floor mounting with supply pipes
Nášlapná baterie
Pro studenou vodu (nebo vstupně smíšenou). Montáž k podlaze pomocí hadiček

Cr | 1.12.360 |

GIARDINO - PISCINA / GARDEN - POOL / ZAHRADA - BAZÉN

Ref. / Nr. / Kód:

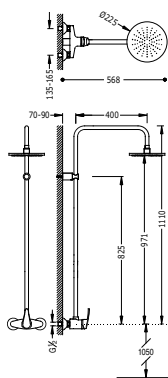

Doccia da giardino o piscina
Monocomando per acqua fredda e calda

Shower for garden or pool
Hot and cold water mixer tap

Zahradní nebo bazénová sprcha
jednopáková baterie na studenou a teplou vodu

Cr 070.995.01

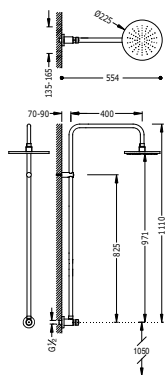

Doccia da giardino o piscina
Temporizzata con 1 tipo di acqua

Shower for garden or pool
Automatic shut-off single water temperature tap

Zahradní nebo bazénová sprcha
s časovým vypínačem pro jednu vodu

Cr 012.996.01

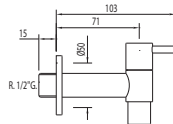

Rubinetto da Giardino
con aeratore.

tap for garden
met perlator.

Zahradní baterie
s perlátorem.

Cr 034.501.01

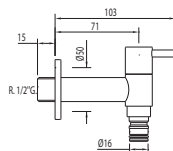

Rubinetto da Giardino
tubo flessibile

tap for garden
hose

Zahradní baterie
hadice

Cr 034.501.02

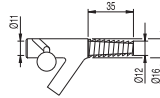

Rubinetto vino N° 5
Wine tap N° 5
Kohoutek na víno č. 5

Cr 0.05.010

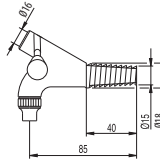

Rubinetto vino N° 1/C
Wine tap N° 1/C
Kohoutek na víno č. 1/C

Cr 0.01.010

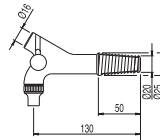

Rubinetto vino N° 2/C
Wine tap N° 2/C
Kohoutek na víno č. 2/C

Cr 0.02.010

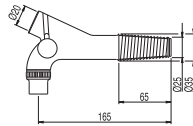

Rubinetto vino N° 3/C
Wine tap N° 3/C
Kohoutek na víno č. 3/C

Cr 0.03.010

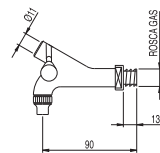

Rubinetto vino N° 1/N
Wine tap N° 1/N
Kohoutek na víno č. 1/N

(3/8" G.)
Cr 0.01.000

(1/2" G.)
Cr 0.01.001

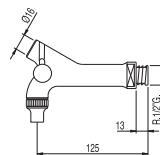

Rubinetto vino N° 2/N
Wine tap N° 2/N
Kohoutek na víno č. 2/N

Cr 0.02.000

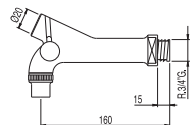

Rubinetto vino N° 3/N
Wine tap N° 3/N
Kohoutek na víno č. 3/N

Cr 0.03.000



MONOTRES 2000



Lavabi
Basin mixer taps
Koupelňová baterie
566



Bidet
Bidets
Bidety
566



Monocomando esterno
Bathtub mixer taps
Jednopákový mechanismus vany
566



Monocomando ad incasso
Built-in sets
Vestavné soupravy
567



Bordovasca
Deck-mounted bathtubs
Vany s prodlouženým pultem
567



Cucina
Kitchen
Kuchyně
568

www.tresgriferia.com



**RICAMBI SU
SPARE PARTS AT
NÁHRADNÍ DÍLY NA**
www.tresgriferia.com

LAVABI MONOCOMANDO / BASIN MIXER TAPS / KOUPELNOVÁ BATERIE

Ref. / Nr. / Kód:

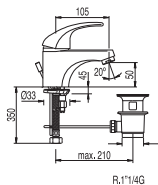

Monocomando lavabo
Single lever washbasin mixer
Jednopáková umyvadlová baterie

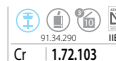

Cr | 1.72.103



Cr | 1.77.103

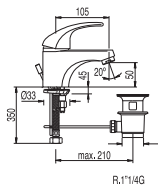

Monocomando lavabo ecologico
Single lever washbasin mixer ecological
Jednopáková umyvadlová baterie s ekologickou funkcí



Cr | 1.72.104



Cr | 1.77.104



BIDET / BIDETS / BIDEY

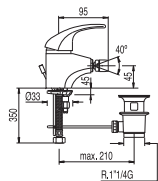

Monocomando bidet
Single lever bidet mixer
Jednopáková bidetová baterie



Cr | 1.72.120



Cr | 1.77.120

MONOCOMANDI BAGNO / BATHTUB MIXER TAPS / JEDNOPÁKOVÝ MECHANISMUS VANY

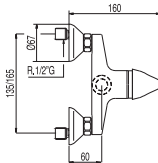

Monocomando doccia
Doccetta anticalcare con supporto orientabile. Flessibile doppia graffatura

Single lever shower mixer
Anti-limescale hand shower with directable support. Double interlocked shower hose

Jednopáková sprchová baterie
Ruční sprcha s nastavitelným držákem, proti usaz. vod. kamene. Flexi hadice s dvojitým opletem



Cr | 1.72.367

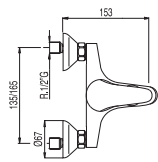

Monocomando vasca
Doccetta anticalcare con supporto orientabile. Flessibile doppia graffatura

Single lever bath and shower mixer
Anti-limescale hand shower with directable support. Double interlocked shower hose

Jednopáková baterie pro vanu-sprchu
Ruční sprcha s nastavitelným držákem, proti usaz. vod. kamene. Flexi hadice s dvojitým opletem



Cr | 1.72.370

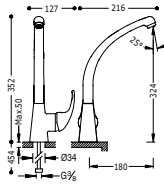

Monocomando lavello verticale
Single lever single hole sink mixer
Jednopáková dřezová baterie svislá



Cr 1.72.447

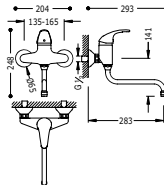

Monocomando a muro
Single lever wall sink mixer
Jednopáková dřezová baterie nástěnná



Cr 1.72.317

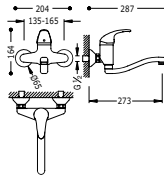

Monocomando a muro
Single lever wall sink mixer
Jednopáková dřezová baterie nástěnná



Cr 1.72.318

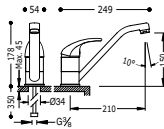

Monocomando lavello verticale
* (per modelli anteriori al listino 2007 ... 91.34.290)
Single lever single hole sink mixer
* (for models before price list 2007 ... 91.34.290)
Jednopáková dřezová baterie svislá
* (do roku 2007 ... 91.34.290)



Cr 1.72.333

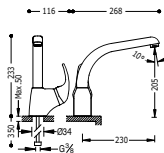

Monocomando lavello verticale
Single lever single hole sink mixer
Jednopáková dřezová baterie svislá



Cr 1.72.440



Bl 4.72.440

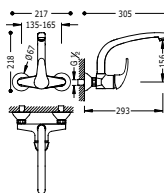

Monocomando a muro
Single lever wall sink mixer
Jednopáková dřezová baterie nástěnná



Cr 1.72.420



ECO-TRES



Lavabi
Basin mixer taps
Koupelňová baterie
572



Bidet
Bidets
Bidety
572



Monocomando esterno
Bathtub mixer taps
Jednopákový mechanismus vany
573



Monocomando ad incasso
Built-in sets
Vestavěné soupravy
573



Bordovasca
Deck-mounted bathtubs
Vany s prodlouženým pultem
575



Cucina
Kitchen
Kuchyně
575

www.tresgriferia.com



RICAMBI SU
SPARE PARTS AT
NÁHRADNÍ DÍLY NA
www.tresgriferia.com

LAVABI MONOCOMANDO / BASIN MIXER TAPS / KOUPELNOVÁ BATERIE

Ref. / Nr. / Kód:

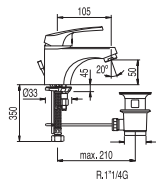

Monocomando lavabo
Single lever washbasin mixer
Jednopáková umyvadlová baterie



Cr | 1.70.103.02



Cr | 1.75.103.02

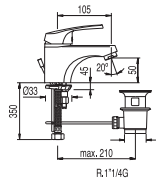

Monocomando lavabo ecologico
Single lever washbasin mixer ecological
Jednopáková umyvadlová baterie s ekologickou funkcí



Cr | 1.70.104.02



Cr | 1.75.104.02

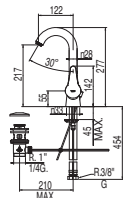

Monocomando lavabo
Single lever washbasin mixer
Jednopáková umyvadlová baterie



Cr | 1.75.308.02

BIDET / BIDETS / BIDETY

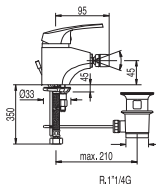

Monocomando bidé
Single lever bidet mixer
Jednopáková bidetová baterie



Cr | 1.70.120.02



Cr | 1.75.120.02

MONOCOMANDI BAGNO / BATHTUB MIXER TAPS / JEDNOPÁKOVÝ MECHANISMUS VANY

Ref. / Nr. / Kód:

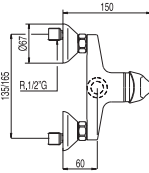

Monocomando doccia
Doccetta anticalcare con supporto orientabile. Flessibile doppia graffatura

Single lever shower mixer
Anti-limescale hand shower with directable support. Double interlocked shower hose

Jednopáková sprchová baterie
Ruční sprcha s nastavitelným držákem, proti usaz. vod. kamene.
Flexi hadice s dvojitým opletem

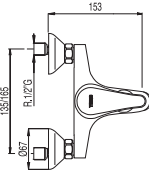

Monocomando vasca
Doccetta anticalcare con supporto orientabile. Flessibile doppia graffatura

Single lever bath and shower mixer
Anti-limescale hand shower with directable support. Double interlocked shower hose

Jednopáková baterie pro vanu-sprchu
Ruční sprcha s nastavitelným držákem, proti usaz. vod. kamene.
Flexi hadice s dvojitým opletem

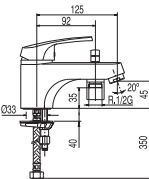

Monocomando vasca
Single lever bath and shower mixer
Jednopáková vanová baterie

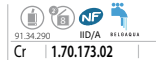

GRUPPI AD INCASSO / BUILT-IN SETS / VESTAVĚNÉ SOUPRAVY

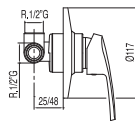

Monocomando incasso (1 via)
corpo incassato incluso
Built-in mixer taps (1 way)
Built-in body included
Vestavěná jednopáková baterie (jednocestný)
včetně podomítkového tělesa

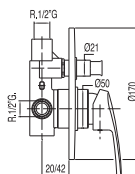

Monocomando incasso (2 vie)
corpo incassato incluso
Built-in mixer taps (2 way)
Built-in body included
Vestavěná jednopáková baterie (dvoucestný)
včetně podomítkového tělesa

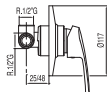
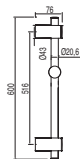

**Kit doccia ad incasso**

Con chiusura e regolazione di portata.

- Corpo incassato incluso
- Asta antiscivolo lunga 516 mm.
- Presa a parete.
- Doccetta Ø 80 mm. (2 funzioni).
- Flessibile satin (91.34.609.15).

Concealed bath & shower kit with water shut off and flow control.

- Built-in body included
- Sliding bar long. 516 mm.
- Elbow wall.
- Massage hand shower Ø 80 mm. (2 functions).
- Satin hose (91.34.609.15).

Sprchová sada vestavná

s uzávěrem a regulací průtoku.

- Včetně podomítkového tělesa
- Posuvná tyč o délce 516 mm.
- Kolínko nástěnným přívodem.
- Ruční masážní sprcha Ø 80 mm. (2 funkce).
- Flexi hadice SATIN (91.34.609.15).



Cr | 1.70.970.02 |

**Kit doccia ad incasso**

Con chiusura e regolazione di portata.

- Corpo incassato incluso
- Doccia fissa Ø 225 mm. con snodo. (299.632.01).
- Doccetta Ø 80 mm. (2 funzioni).
- Flessibile satin (91.34.609.15).

Concealed shower kit with water shut off and flow control.

- Built-in body included
- Fixed shower head Ø 225 mm. with ball joint. (299.632.01).
- Massage hand shower Ø 80 mm. (2 functions).
- Satin hose (91.34.609.15).

Sprchová sada vestavná

s uzávěrem a regulací průtoku.

- Včetně podomítkového tělesa
- Pevná sprcha Ø 225 mm. s kloubem. (299.632.01).
- Ruční masážní sprcha Ø 80 mm. (2 funkce).
- Flexi hadice SATIN (91.34.609.15).

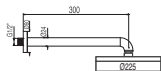

Cr | 070.990.02 |

**Kit doccia ad incasso**

Con chiusura e regolazione di portata.

- Corpo incassato incluso
- Doccia fissa Ø 225 mm. con snodo. (299.632.01).
- Asta antiscivolo lunga 516 mm.
- Presa a parete (205.183.01).
- Doccetta Ø 80 mm. (2 funzioni).
- Flessibile satin (91.34.609.15).

Concealed bath & shower kit with water shut off and flow control.

- Built-in body included
- Fixed shower head Ø 225 mm. with ball joint. (299.632.01).
- Sliding bar long. 516 mm.
- Elbow wall (205.183.01).
- Massage hand shower Ø 80 mm. (2 functions).
- Satin hose (91.34.609.15).

Sprchová sada vestavná

s uzávěrem a regulací průtoku.

- Včetně podomítkového tělesa
- Pevná sprcha Ø 225 mm. s kloubem. (299.632.01).
- Posuvná tyč o délce 516 mm.
- Kolínko nástěnným přívodem (205.183.01).
- Ruční masážní sprcha Ø 80 mm. (2 funkce).
- Flexi hadice SATIN (91.34.609.15).



Cr | 1.70.970.02 |

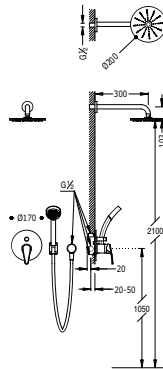

Kit doccia ad incasso

- Doccia fissa Ø 200 mm. con snodo (299.632.12).
- Presa a parete.
- Doccetta anticalcare Ø 80 mm.
- Flessibile doppia graffatura.

Concealed bath & shower kit

- Fixed shower head Ø 200 mm. with ball joint (299.632.12).
- Elbow wall.
- Shower Antilime Ø 80 mm.
- Double interlocked shower hose.

Sprchová sada vestavná

- Pevná sprcha Ø 200 mm. s kloubem (299.632.12).
- Kolíčko nástěnným přívodem.
- Sprcha proti usaz. vod. kamene Ø 80 mm.
- Flexi hadice s dvojitým zámkem.



91.34.290

Cr | 070.880.02 |

BORDOVASCA / DECK-MOUNTED BATHTUBS / VANY S PRODLOUŽENÝM PULTEM

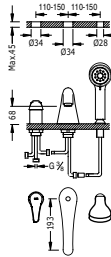

Monocomando bordo vasca

- Doccetta massaggi. (3 funzioni).
- Portata: 3 bar – 15 l/m.

Bath-shower single lever tap for bracket shelf

- Massage hand shower. (3 fonctions).
- Flowrate: 3 bar – 15 l/m.

Jednopávková stojánková vanová baterie

- Masážní ruční sprcha. (3 proudy).
- Průtok: 3 bar – 15 l/m



91.34.288

Cr | 070.145.02 |

CUCINA / KITCHEN / KUCHYNĚ

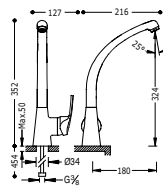

Monocomando lavello verticale

- Single lever single hole sink mixer
- Jednopávková dřezová baterie svislá



Ø 33

360° 91.34.288

Cr | 1.70.447.02 |

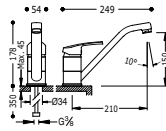

Monocomandoavello verticale
 * (per modelli anteriori al listino 2007 ... 91.34.290)
Single lever single hole sink mixer
 * (for models before price list 2007 ... 91.34.290)
 Jednopáková dřezová baterie svislá
 * (do roku 2007 ... 91.34.290)

Ø 33 360° 91.34.288° IA IIB
Cr 1.70.333.02

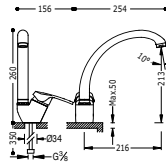

Monocomandoavello verticale
Single lever single hole sink mixer
 Jednopáková dřezová baterie svislá

Ø 33 360° 91.34.288
Cr 1.70.441.02

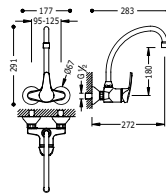

Monocomando a muro
Single lever wall sink mixer
 Jednopáková dřezová baterie nástěnná

135-165 360° 91.34.290
Cr 1.70.318.02

95-125 360° 91.34.290
Cr 1.70.218.02

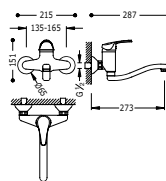

Monocomando a muro
Single lever wall sink mixer
 Jednopáková dřezová baterie nástěnná

135-165 360° 91.34.290 (200 mm.)
Cr 1.70.320.02

135-165 360° 91.34.290 (160 mm.)
Cr 1.70.418.02

135-165 360° 91.34.290 (130 mm.)
Cr 070.320.03

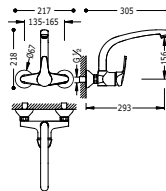

Monocomando a muro
Single lever wall sink mixer
 Jednopáková dřezová baterie nástěnná

135-165 360° 91.34.290
Cr 1.70.332.02

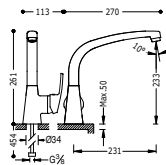

Monocomandoavello verticale
Single lever single hole sink mixer
 Jednopáková dřezová baterie svislá

Ø 33 360° 91.34.288
Cr 070.448.02

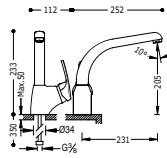

Monocomando lavello verticale
Single lever single hole sink mixer
Jednopláková dřezová baterie svislá





ESE-23



Lavabi
Basin mixer taps
Koupelňová baterie
580



Bidet
Bidets
Bidety
580



Doppi comandi bagno
Bathroom dual control taps
Vanové baterie s dvoupákovým mechanismem
581



Cucina
Kitchen
Kuchyně
581

www.tresgriferia.com



**RICAMBI SU
SPARE PARTS AT
NÁHRADNÍ DÍLY NA**
www.tresgriferia.com

LAVABI MONOCOMANDO / BASIN MIXER TAPS / UMYVADLOVÉ BATERIE S JEDNOPÁKOVÝM MECHANISMEM

Ref. / Nr. / Kód:

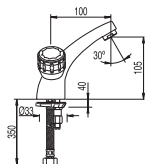

Monoblocco lavabo
Basin pillar tap
Umyvadlová baterie



91.34.284

Cr | 1.23.103

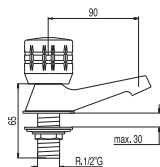

Monoblocco lavabo
Basin pillar tap
Umyvadlová baterie



91.34.284

Cr | 1.23.100.F



91.34.284

Cr | 1.23.100.C

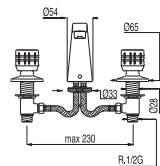

Accumulatore lavabo
Wash-basin mixer
Umyvadlová baterie



91.34.285

Cr | 1.23.105

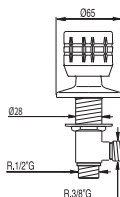

Rubinetto laterale
Lateral tap
Boční baterie



91.34.285

Cr | 1.23.510.F



91.34.285

Cr | 1.23.510.C

BIDET / BIDEYS / BIDEY

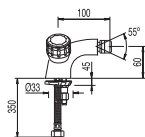

Rubinetto bidet
Bidet
Bidetová baterie



91.34.284

Cr | 1.23.120

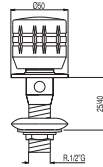

Rubinetto bidet da 1/2"
Bidet 1/2"
Bidetová baterie 1/2"



Cr 1.23.125.F



Cr 1.23.125.C

DOPPI COMANDI BAGNO / BATHROOM DUAL CONTROL TAPS / VANOVÉ BATERIE S DVOUPÁKOVÝM MECHANISMEM

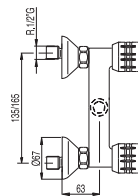

Gruppo doccia
Doccetta anticalcare con supporto orientabile. Flessibile doppia
graffatura

Shower mixer
Anti-limescale hand shower with directable support. Double
interlocked shower hose

Sprchový celek
Ruční sprcha s nastavitelným držákem, proti usaz. vod. kamene.
Flexi hadice s dvojitým opletem



Cr 1.23.167

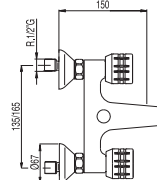

Gruppo vasca
Doccetta anticalcare con supporto orientabile. Flessibile doppia
graffatura

Bath and shower mixer
Anti-limescale hand shower with directable support. Double
interlocked shower hose

Celek vana-sprcha
Ruční sprcha s nastavitelným držákem, proti usaz. vod. kamene.
Flexi hadice s dvojitým opletem



Cr 1.23.170

CUCINA / KITCHEN / KUCHYNĚ

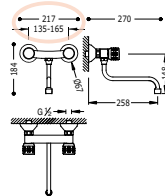

Gruppo lavello parete
Wall sink mixer
Nástěnný dřezový celek



Cr 1.23.310

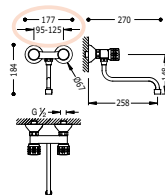

Gruppo lavello parete
Distanza da parete di 260 mm.
Wall sink mixer
Distance from wall 260 mm.
Nástěnný dřezový celek
vzdálenost od zdi 260 mm



Cr 1.23.310

Ref./Nr./Kód: |

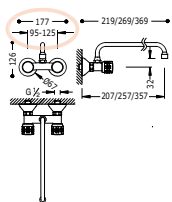

Gruppo lavello parete
Wall sink mixer
Nástěnný dřezový celek

9.5-12.5 360° 91.34.284 (207 mm.)
Cr | 1.23.214 |

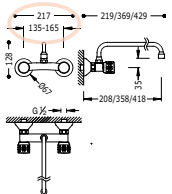

Gruppo lavello parete
Wall sink mixer
Nástěnný dřezový celek

9.5-12.5 360° 91.34.284 (257 mm.)
Cr | 1.23.215 |

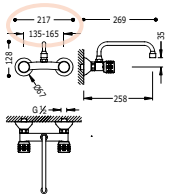

Gruppo lavello parete
Wall sink mixer
Nástěnný dřezový celek

9.5-12.5 360° 91.34.284 (357 mm.)
Cr | 1.23.230 |

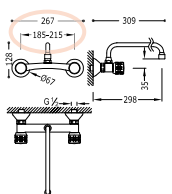

Gruppo lavello parete
Wall sink mixer
Nástěnný dřezový celek

13.5-16.5 360° 91.34.284 (208 mm.)
Cr | 1.23.314 |

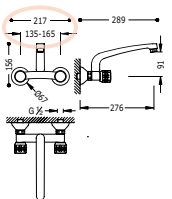

Gruppo lavello parete
Wall sink mixer
Nástěnný dřezový celek

13.5-16.5 360° 91.34.284 (358 mm.)
Cr | 1.23.330 |

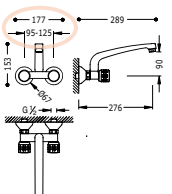

Gruppo lavello parete
Wall sink mixer
Nástěnný dřezový celek

13.5-16.5 360° 91.34.284 (418 mm.)
Cr | 1.23.360 |

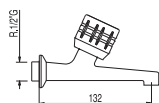

Monocomando lavello verticale
Single lever single hole sink mixer
Dřezová baterie



91.34.283
Cr | 1.23.520.F |



91.34.283
Cr | 1.23.520.C |

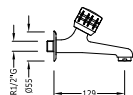

Monocomando lavello verticale
Single lever single hole sink mixer
Dřezová baterie



91.34.283
Cr | 023.520.01.F |



91.34.283
Cr | 023.520.01.C |

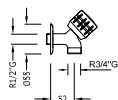

Rubinetto lavatrice
1/2" - 3/4"
Washing machine tap
1/2" - 3/4"
Kohoutek pro pračku
1/2" - 3/4"



91.34.283
Cr | 1.23.500.F |



91.34.283
Cr | 1.23.500.C |

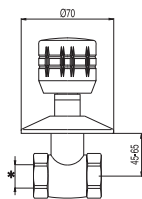

Rubinetto di arresto filettato
Valve
Uzavírací ventil podomítková



91.34.286
Cr | 1.23.155.F |



91.34.286
Cr | 1.23.511.F |



91.34.286
Cr | 1.23.512.F |



91.34.287
Cr | 1.23.513.F |

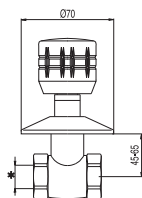

Rubinetto di arresto filettato
Valve
Uzavírací ventil podomítková



91.34.286
Cr | 1.23.155.C |



91.34.286
Cr | 1.23.511.C |



91.34.286
Cr | 1.23.512.C |



91.34.287
Cr | 1.23.513.C |

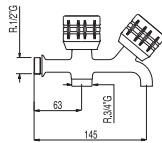

Rubinetto lavatrice
1/2" - 3/4"
Washing machine tap
1/2" - 3/4"
Dvojitý kohoutek pro pračku
1/2" - 3/4"



91.34.283
Cr | **1.23.515** |

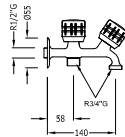

Rubinetto lavatrice
1/2" - 3/4" - 3/4"
Washing machine tap
1/2" - 3/4" - 3/4"
Dvojitý kohoutek pro pračku
1/2" - 3/4" - 3/4"



91.34.283
Cr | **023.515.01** |

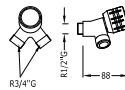

Rubinetto doppio
1/2" - 3/4"
Double tap
1/2" - 3/4"
Poklepaní
1/2" - 3/4"



91.34.283
Cr | **023.516.01** |

RUBINETTI DI ARRESTO / SHUTOFF VALVES / PRŮCHOZÍ VENTILY

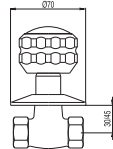

Rubinetto di arresto
1/2" Avvitare
Threaded-ends gate-valve
1/2" Screw
Uzavírací ventil
k zašroubování 1/2"



91.34.296
Cr | **1.33.155.10.F** |



91.34.296
Cr | **1.33.155.10.C** |

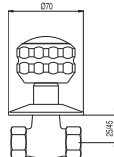

Rubinetto di arresto
3/4" Avvitare
Threaded-ends gate-valve
3/4" Screw
Uzavírací ventil
k zašroubování 3/4"



91.34.297
Cr | **1.33.157.10.F** |



91.34.297
Cr | **1.33.157.10.C** |

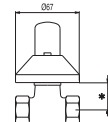

Rubinetto di arresto
Threaded-ends gate-valve
Uzavírací ventil



91.34.296 1/2" 20/55
Cr | **1.33.516** |



91.34.297 3/4" 20/60
Cr | **1.33.517** |



91.34.298 1" 30/70
Cr | **1.33.518** |

LISTA DI CODICI ARTICOLI / NUMERICAL LIST OF REFERENCES / ČÍSELNÝ SEZNAM KÓDŮ

Ref./Nr./Kód	Price	Page No.	Ref./Nr./Kód	Price	Page No.	Ref./Nr./Kód	Price	Page No.	Ref./Nr./Kód	Price	Page No.
00			00626001	384	02352001C	584	03411601RO	230	06116101	411	
001000	563		00626010	384	02352001F	584	03411601VE	230	06116201	238	
001001	563		0064378M	99	02416404	514	03411601VI	230	06116201	412	
001010	563		00648501	381	02416404LV	514	03412401	403	06116201	440	
002000	563		00648501ACD	44	02416409	512	03412401	426	06116201	440	
002010	563		0064868M	96	02416409LV	512	03412401	437	06116209	238	
003000	563		0064878M	99	02417409	512	03412401	437	06116209	412	
003010	563		00661001	379	02417409LV	512	03412401	448	06116701	407	
005010	563		00661001ACD	42	02417609	512	03412401	462	06117001	407	
00610101	379		00661001BLD	42	02417609LV	512	03412401	558	06117201	240	
00610101ACD	42		00661001NED	42	02417712	510	03412402	388	06117201	412	
00610101BLD	42		00661002	378	02418012	510	03412402	518	06117201	440	
00610101D	379		00663901	230	02418201	335	03433601	311	06117201	440	
00610101NED	42		00663901AC	230	02419401LV	370	03433603	311	06117202	366	
00610102	378		00663901BL	230	02419401LV	493	03433604	311	06117209	240	
00610503	385		00663901NG	230	02419401LV	502	03450101	562	06117209	412	
00610503AC	45		00681001	379	02419401LV	512	03450102	562	06118201	335	
00610504	385		00681001ACD	42	02419501	513	03452602	311	06118301	337	
00610504AC	45		00681001BLD	42	02419502	513	03452702	311	06120301	397	
00611001	380		00681001NED	42	02419502LV	513	03454002	358	06120301D	397	
00611001BLD	43		00681002	378	02419801	513	03462902	269	06120304	400	
00611001D	380		00698001	277	02420301	506	03463628	269	06120306	400	
00611001NED	43		00698001	390	02420301LV	506	03463629	269	06120601	397	
00611002	380		00712001	387	02421301	500	03463630	269	06120701	397	
00611002BLD	43		00712001ACD	46	02421301	509	03463701	307	06121001	256	
00611002D	380		00712001BLD	46	02421301LV	500	03463702	308	06121001	414	
00611002NED	43		00712001D	387	02421301LV	509	03463706	310	06122001	405	
00612001	387		00712001NED	46	02421501	542	03463707	313	06122001D	405	
00612001ACD	46		00715501	393	02422001	508	03463708	308	06125001	242	
00612001BLD	46		00716402	258	02422001LV	508	03463901	230	06125002	243	
00612001D	387		00717402	263	02431001	542	03463901AC	230	06125003	243	
00612001NED	46		00719101	272	02447601	317	03463901AM	230	06125004	243	
00612301	388		00719101	388	02487101	369	03463901BL	230	06138501	260	
00612302	388		00719501	253	02487101	493	03463901FU	230	06138502	265	
00612302AC	558		00719701	272	02487101	502	03463901NA	230	06139301	256	
00612302BLD	46		00731201	262	02487101	512	03463901NE	230	06139301	413	
00612302D	387		00731201	392	02487101LV	493	03463901RO	230	06144701	402	
00612302NED	46		00738501	259	02487101LV	502	03463901VE	230	06144701	435	
00613001	387		00738502	264	02487101LV	512	03463901VI	230	06144701	435	
00616103	287		00749501	252	03			03474007	362	06144701	548
00616103AC	391		00750301AC	44	030335AC	100	03493101	229	06144801	402	
00616103AC	48		00810501	386	030335BM	100	03493199	229	06144801	435	
00616104	287		00810501AC	46	030336AC	98	03493209	239	06144801	435	
00616104AC	391		00810502	386	030336BM	98	03944401	521	06144801	548	
00616105	287		00810503	386	03035501	535	04			06151101	415
00616105AC	391		00810503AC	45	03044401	530	04217712	491	06151101	428	
00616105AC	48		00810504	386	03045501	535	04218012	491	06163505	319	
00616106	287		00815101	385	030496BM	96	04219401	492	06163505	318	
00616106AC	391		00815201	385	0304978M	96	04219401LV	492	06163506	320	
00617703	275		00815301	386	030498BM	96	04219402LV	492	06163507	321	
00618003	276		00815301	386	03216402	494	06			06163509	323
00618003AC	390		00815301AC	46	03216402LV	494	06110301	396	06183901AM	233	
00618003AC	47		00815401	386	03216402LV	494	06110302	396	06183901BL	233	
00618006	277		00815401AC	46	03216409	493	06110302D	399	06183901FB	233	
00618080	276		00815401AC	46	03216409LV	493	06110303	399	06183901NA	233	
00618080AC	390		00815401AC	101	03217409	493	06110303D	399	06183901RO	233	
00618201	335		01210002	547	03217409LV	501	06110303D	400	06183901VE	233	
00618201AC	335		01210003	546	03217609	493	06110303D	400	06183901VI	233	
00618301	337		01210302	546	03217609LV	501	06110501	60	06193102	314	
00618301AC	337		01210303	546	03217609LV	493	06110502	60	06193103	315	
00620003	384		01212701	552	03217609LV	493	06111001	399	06193104	315	
00620003AC	538		01220002	550	03217609LV	493	06111001	60	06193105	315	
00620003AC	44		01220002	550	03217609LV	493	06111001	399	06193105	315	
00620003AC	100		01220701	550	03219501	494	06112001	405	06193105	315	
00620004	384		01220701	550	03219501	503	06112001ACD	61	06210301	396	
00620004AC	538		01220801	550	03219501	503	06112001BMD	61	06210302	399	
00620004AC	100		01229601	562	03219502	494	06112001TAMD	61	06210302D	399	
00620004AC	384		01271702	485	03219502LV	494	06112001TAD	61	06210302D	401	
00620004AC	538		01271712	485	03219502LV	502	06112001TAD	61	06210302D	401	
00620004AC	44		01271712	485	03219801	495	06112001TAD	61	06210303	399	
00620004AC	100		01271712	537	03219801	495	06112001TAD	61	06210303D	399	
00620004AC	384		01271802	485	03219801	495	06112001TAD	61	06210303D	401	
00620004AC	538		01271802	486	03219801	503	06112001TAD	61	06210303D	399	
00620004AC	44		01271802	486	03411601	230	06112001TAD	61	06210303D	401	
00620004AC	100		01271802	486	03411601AC	230	06112001TAD	61	06211001	399	
00620004AC	384		01271802	486	03411601AM	230	06112001TAD	61	06211001	405	
00620011	385		01271802	486	03411601BL	230	06112001TAD	61	06212001ACD	61	
00620011AC	379		01271802	486	03411601LV	230	06112001TAD	61	06212001BMD	61	
00620011AC	44		01271802	486	03411601NA	230	06112001TAD	61	06212001D	405	
00620011AC	100		01271802	486	03411601NE	230	06112001TAD	61	06212001TAMD	61	
00620011AC	380		01271802	486							
00620011ACD	43		02351501	585							
00620011BLD	43		02351601	585							
00620011NED	43										
00620501ACD	44										

Ref./Nr./Kód	Price	Page No.	Ref./Nr./Kód	Price	Page No.	Ref./Nr./Kód	Price	Page No.	Ref./Nr./Kód	Price	Page No.	Ref./Nr./Kód	Price	Page No.
06212001BLD	61		06339301	414		09097401	453		10620501	381		112100	547	
06212001FUD	61		06910302	476		09097401	466		106245	290		112103	547	
06212001TNAD	61		06910302D	476		09097401	560		106245	391		112161	551	
06212001TNEAD	61		06913001	477		09217101	549		106377	275		11216150	551	
06212001TROD	61		06916702	477		09286299	162		106437	528		112162	552	
06212001TVED	61		06917002	477		09286301	177		106440	521		112163	551	
06212001TVID	61		06917501	478		09286302	177		106486	520		112167	551	
06213001	406		06917712	478		09286303	178		106486AM	96		112177	552	
06215001AC	66		06918012	478		09286304	178		106486FU	96		112178	552	
06216102	288		06918080	479		09286305	179		106486NA	96		112200	550	
06216102	410		06930802D	476		09286306	179		106486RO	96		112203	446	
06216103	288		06944401	525		09286307	180		106486VE	96		112203	460	
06216103	410		06944401	530		09286308	180		106486VI	96		112203	546	
06216402	258		06944701	525		09286309	181		106487	528		112205	550	
06216801	194					09286310	181		106487AM	99		112206	550	
06217402	264					09286311	182		106487FU	99		112207	551	
06217702	408					09286312	182		106487NA	99		112360	537	
06217703	278		0701770212	573		09286313	183		106487RO	99		112360	553	
06217801	194		0701800212	573		09286314	183		106487VE	99		112360	561	
06218002	408		07032003	576		09286315	184		106487VI	99		112370	537	
06218003	197		07044802	576		09286316	184		106603	382		112370	553	
06218005	279		07088002	575		09286317	185		106604	382		112370	561	
06218006	198		07099002	574		09286318	185		106605	382		112441	553	
06218007	198		07099501	562		09286319	186		106606	382		112441	561	
06218008	199		07217712	567		09286320	186		106607	382		113333	527	
06218009	279		07218012	567		09286321	187		10691405	265		114444	530	
06218009	410					09286322	187		10691405	339		11463601	346	
06218010	198					09286398	163		106980	276		11463602	346	
06218011	199					09286399	162		106980	389		11463603	346	
06218012	200		08115001	288		09286401	188		106985	277		11463609	346	
06218013	201		08115001	452		09286402	188		107103	381		11463610	346	
06218080	409		08116103	288		09286403	189		10710342	362		117103	484	
06220001	404		08116103	452		09286404	189		107103DA	381		117103DA	484	
06220002	404		08116104	288		09286405	190		107131	316		117104	484	
06220002	539		08116104	452		09286406	190		10716102	289		117104DA	484	
06220002AC	101		08119301	272		09286407	191		10716102	391		117145	487	
06220003	404		08119301	450		09286408	191		107164	238		117175	486	
06220003	539		08119701	273		09286499	163		107164	392		117333	526	
06220003AC	101		08119701	450		09286501	249		1071649	238		117377	486	
06220070	404		08119702	273		09286502	249		1071649	392		117440	525	
06220071	404		08119702	449		09286508	249		107167	388		117980	487	
06220071	539		08120001	447		09286551	37		10717002	388				
06220071AC	101		08120021	447		09286551	164		107174	240				
062200AC	101		08120021	539		09286552	165		107174	392		123100C	580	
062200BM	101		08126010	447		09286553	169		1071749	240		123100F	580	
06220301	398		08149501	252		09286554	69		1071749	392		123103	580	
06220301D	398					09286554	171		107181	366		123105	580	
06220304	401					09286555	172		107250	242		123120	580	
06220306	401		09018601	239		09286556	176		107251	243		123125C	581	
06220601	398		09018602	259		09286557	173		107252	243		123125F	581	
06220701	398		09026401	239		09286558	174		107253	243		123155C	584	
06222001	405		09026401	413		09286561	166		107395	253		123155F	584	
06222001D	405		09026401	427		09286562	166		107395	392		123167	581	
06226010	404		09026401	440		09286563	167		107440	521		123170	581	
06231201	263		09026401	440		09286564	167		107476	317		123210	581	
06231201	415		09026401	453		09286565	173		107503	384		123214	582	
06237801	195		09026401	465		09286566	174		107511	393		123215	582	
06243201	305		09026401	560		09286567	175		10763601	345		123217	582	
062435AC	97		09027401	241		09286568	175		10763603	345		123230	582	
062435BM	97		09027401	413		09286570	169		10763606	345		123306	583	
06243601AC	98		09027401	427		09286571	170		10763608	345		123310	581	
06243601BM	98		09027401	440		09286573	176		10763620	345		123314	582	
06248701	529		09027401	440		09286580	164		10763623	345		123315	582	
06248801	521		09027401	453		09286581	165		10763627	345		123317	582	
06251601	279		09027401	466		09286582	171		107839	336		123330	582	
06251601	409		09027401	560		09286583	172		107922	307		123342	583	
06254201	523		09049501	252		09286584	168		107926	316		123360	582	
06254201AC	98		09096001	246		09286585	168		107934	312		123416	582	
06254201BM	98		09096002	246					107935	307		123500C	584	
06290501	402		09096401	239					107940	355		123500F	584	
06290502	402		09096401	413		104840	361		107964	260		123505	583	
06290503	402		09096401	427		104841	361		108124	387		123506	583	
06298001	278		09096401	440		106103	381		108496	383		123510C	580	
06298001	409		09096401	440		106103DA	381		108496	541		123510F	580	
06298002	280		09096401	453		106124	387		108497	383		123511C	584	
06316201	412		09096401	465		10616102	289		108497	541		123511F	584	
06316209	412		09096401	560		10616102	391		108498	541		123512C	584	
06317201	412		09097401	241		106177	389		108604	383		123512F	584	
06317209	412		09097401	413		10617710	389		108605	383		123513C	584	
06321101	414		09097401	427		106180	389		108606	383		123513F	584	
06331201	263		09097401	440		10618010	389					123515	585	
06331201	415		09097401	440		106200	384					123520C	584	

LISTA DI CODICI ARTICOLI / NUMERICAL LIST OF REFERENCES / ČÍSELNÝ SEZNAM KÓDŮ

Ref./Nr./Kód	Price	Page No.	Ref./Nr./Kód	Price	Page No.	Ref./Nr./Kód	Price	Page No.	Ref./Nr./Kód	Price	Page No.	
123520F	584		132176	500		13446302	265		134871	369	16216150	365
124125C	507		132335	542		13446302	339		134873	337	162177	408
124125F	507		132342	542		134512	312		134903	228	162180	408
12414561	511		132416	543		134516	306		134923	314	162200	404
124146	511		132510C	498		134517	306		134940	217	162200	539
124151	507		132510F	498		134520	307		13494010	355	162245	290
12415561C	515		132768	499		13452102	305		13494110	355	162245	411
12415561F	515		132774	499		134522	312		13494210	355	16235590	535
12415761C	515		13315510C	585		13452202	305		134944	224	162435	522
12415761F	515		13315510F	585		134526	311		134950	227	162436	522
12416761	508		133155C	503		134527	311		134951	224	162437	529
12417061	508		133155F	503		134530	326		137103	498	162438	529
124173	367		13315710C	585		134531	326		137104	498	162440	524
124173	510		13315710F	585		13453410	360		137106	498	162441	523
124194	370		133157C	503		13453420	360		137120	499	162442	524
124194	493		133157F	503		13453430	360		137124	499	162453	535
124194	502		133516	585		13453440	360		139102	484	162456	535
124194	512		133517	585		13454010	355		139102DA	484	162503	403
1242807	509		133518	585		13454030	357		139103	484	162503	446
1242907	509		134121	298		13454050	356		139103DA	484	162503	460
124306	507		134122	406		13454060	355		139104	484	162540	523
124334	532		134122	462		13454070	356		139104DA	484	162541	522
124341	526		134122	558		13454110	357		139120	485	162603	403
12434261	542		134123	406		13454160	357		139120DA	485	162603	446
124500	515		134123	462		13454190	357		139441	526	162603	460
124503	507		134123	558		134550	275				162840	354
124520	515		13413726	252		134550	408				163103	402
12463601	350		13413726	303		134552	361		14210302	490	163120	406
12463603	350		13413730	252		134611	252		14212002	490	163145	289
12463604	351		13413730	303		134611	325		14214502	492	163145	411
12463605	350		13413826	252		134612	252		14216702	491	163151	404
12463606	350		13413826	302		134612	325		14217002	491	163151	540
12463607	351		13413830	252		134617	327		14219402	492	163152	404
12463608	350		13413830	302		134618	308		14244102	527	163194	407
12463609	350		13413940	304		134619	308		143835	309	163250	242
12463610	351		134161	537		13462101	304		143836	315	163251	243
12463611	350		13416703	552		13462102	305		14710302	490	163252	243
12463612	350		13416803	552		13462104	304		14712002	490	163253	243
12463613	351		134183	347		13462202	305				163333	542
12463615	350		134184	347		134627	327				163868	407
124824	328		13418440	347		134628	314		16110342	362	163874	407
124824	510		13419502	265		134629	314		16110362	362	168103	402
12910361	506		13419502	339		13463310	359		16110372	363	168105	404
12910461	506		134221	299		13463410	363		16117002	366	168120	406
12910561	506		134231	300		13463420	363		16117102	366	169103	476
129106	507		134232	300		13463430	363		16118740	304	169103DA	476
12912061	508		134233	301		13463440	363		161194	241	169104	476
12912461	508		13424010	356		13463450	359		161194	369	169104DA	476
			13424020	356		13463460	364		161194	412	169120	477
			13424030	356		13463624	346		161213	323	169120DA	477
130335	532		134245	291		134637	338		161214	320	169145	479
130336	522		134245	492		13463810	363		161445	403	169333	526
130337	526		134301	367		13463820	364		161445	435	169377	478
130338	526		134302	367		13463910	358		161445	435	169440	525
13035590	375		134303	367		134714	296		161445	533	169980	479
130432	530		134331	299		134715	297		161445	533		
130434	530		13434010	355		134732	310		161445	549		
130481	537		13434020	357		134732	500		161446	403	17010302	572
130484	537		13434120	356		134732	510		161446	435	1701030211	560
130485	536		134345	290		134737	310		161446	435	17010402	572
130487	529		134345	411		134738	330		161446	533	17012002	572
130493	536		134345	501		13473850	330		161446	533	17016702	573
130495	537		134345	511		13474010	361		161446	549	17017002	573
130496	520		134431	300		13474020	361		161475	318	17017302	573
130497	521		134432	300		13474110	370		161476	319	17021802	576
130497AM	96		134433	301		13474210	368		16163601	346	17031802	576
130497FU	96		134445	291		13474220	368		16163602	346	17032002	576
130497NA	96		134445	391		13474310	358		16163606	346	17033202	576
130497RO	96		134445	391		13474320	358		16163615	348	17033302	576
130497VE	96		134445	410		13474330	358		16163616	347	17041802	576
130497VI	96		134445	411		134748	252		16163618	347	17044002	577
130498	520		134445	411		134748	326		16163620	347	17044102	576
132100C	498		134445	426		134757	337		16163623	346	17044702	575
132100F	498		134445	439		134802	328		16163624	346	17097002	574
132103	498		134445	439		134808	330		161835	309	17098002	574
132104	498		134445	452		134818	329		161838	309	172103	566
132120	499		134445	452		134821	327		161839	336	172104	566
132124	499		134445	465		134823	327		161840	354	172120	566
132125C	499		134445	492		134831	327		162113	462	172145	567
132125F	499		134445	501		134835	309		162113	559	172218	569
132130	499		134445	511		134846	360		162161	289	172317	568
132145	501		13445301	535		134870	369		162161	411	172318	568

Ref./Nr./Kód	Price	Page No.	Ref./Nr./Kód	Price	Page No.	Ref./Nr./Kód	Price	Page No.	Ref./Nr./Kód	Price	Page No.	
17231811	560		186207	445		20010302AMD	74		20016409RO	85	20020002	538
172333	568		186217	445		20010302AMD	76		20016409VE	85	20020002AC	82
17233311	560		186903	445		20010302BLD	74		20016409VI	85	20020002AC	101
172367	566		186920	447		20010302BLD	76		20016701	424	20020003	422
172370	566		18718250	365		20010302BMD	74		20016701AC	83	20020003	538
172418	569		187440	521		20010302BMD	77		20016701AM	83	20020303	420
172420	568		187444	530		20010302D	419		20016701BL	83	20020303ACD	79
172440	568		189245	291		20010302D	418		20016701BM	83	20020303AMD	78
172443	569		189245	452		20010302FUD	74		20016701FU	83	20020303BLD	78
172447	568					20010302FUD	76		20016701NA	83	20020303BMD	79
172450	561					20010302NAD	74		20016701NE	83	20020303FUD	78
17510302	572		190150	245		20010302NAD	76		20016701RO	83	20020303NAD	78
17510402	572		190151	246		20010302NED	74		20016701VE	83	20020303NED	78
17512002	572		190162	239		20010302NED	76		20016701VI	83	20020303ROD	78
17530802	572		1901629	239		20010302ROD	74		20017001	424	20020303VED	78
177103	566		190165	245		20010302ROD	76		20017001AC	84	20020303VID	78
177104	566		190172	241		20010302VED	74		20017001AM	84	20020304	419
177120	566		1901729	241		20010302VED	76		20017001BL	84	20020304ACD	77
			190186	239		20010302VID	74		20017001BM	84	20020304AMD	76
			190194	514		20010302VID	76		20017001FU	84	20020304BLD	76
			190213	254		20011001	418		20017001NA	84	20020304BMD	77
181103	444		190213	454		20011001AMD	75		20017001NE	84	20020304FUD	76
181113	448		190214	256		20011001BLD	75		20017001RO	84	20020304NAD	76
181113	559		190214	454		20011001FUD	75		20017001VE	84	20020304NED	76
181120	447		190214	454		20011001NAD	75		20017001VI	84	20020304ROD	76
181164	238		190214	466		20011001NED	75		20017401	240	20020304VED	76
181164	453		190385	261		20011001ROD	75		20017401	426	20020304VID	76
181164	465		190387	261		20011001VID	75		20017409	240	20020305	420
1811649	238		190388	261		20011001VID	75		20017409	426	20020305ACD	79
1811649	453		190547	245		20011002	418		20017409AC	86	20020305AMD	78
1811649	465		190552	245		20011002AMD	75		20017409AM	86	20020305BLD	78
181174	240		190647	245		20011002BLD	75		20017409BL	86	20020305BMD	79
181174	453		190652	245		20011002FUD	75		20017409BM	86	20020305FUD	78
181174	465		190970	247		20011002NAD	75		20017409FU	86	20020305NAD	78
1811749	240		192445	533		20011002NED	75		20017409FU	86	20020305NED	78
1811749	453		192445	553		20011002ROD	75		20017409NE	86	20020305ROD	78
1811749	465		19250730	368		20011002VED	75		20017409RO	86	20020305VED	78
181175	455		19250730	549		20011002VID	75		20017409VE	86	20020305VID	78
181175	467		19260603	548		20012001	422		20017409VI	86	20020305VID	78
18117705	451		19290603	548		20012001	422		20017409VI	86	20020306	419
18118005	451		193123	268		20012001ACD	82		20017701	424	20020306ACD	77
181191	273		193124	268		20012001AMD	82		20017702	282	20020306AMD	76
181191	449		193223	268		20012001BLD	82		20018001	424	20020306BLD	76
18119502	265		19417019	371		20012001BMD	82		20018002	282	20020306BMD	77
18119502	339		19417029	371		20012001D	422		20018002	425	20020306FUD	76
181200	447					20012001FUD	82		20018002AM	84	20020306NAD	76
181200	539					20012001NAD	82		20018002BL	84	20020306NED	76
181203	445		20010101	420		20012001NED	82		20018002FUD	84	20020306ROD	76
181207	445		20010101	418		20012001ROD	82		20018002NA	84	20020306VED	76
181217	445		20010101D	420		20012001VED	82		20018002NE	84	20020306VID	76
181222	448		20010101D	418		20012001VID	82		20018002RO	84	20020501	421
181222	558		20010102	419		20012002	422		20018002VE	84	20020501ACD	81
181223	448		20010102	418		20012002ACD	82		20018002VI	84	20020501AMD	81
181223	558		20010102D	419		20012002AMD	82		20018003	283	20020501BLD	81
181224	447		20010102D	418		20012002BLD	82		20018004	283	20020501BMD	81
181251	243		20010301	420		20012002BMD	82		20018005	282	20020501FUD	81
181303	446		20010301	418		20012002D	422		20018005	425	20020501NAD	81
181333	524		20010301ACD	74		20012002FUD	82		20018005AC	85	20020501NED	81
181341	524		20010301ACD	79		20012002NAD	82		20018005BM	85	20020501ROD	81
181385	257		20010301AMD	74		20012002NED	82		20018010	424	20020501VED	81
181385	454		20010301AMD	78		20012002ROD	82		20018080	425	20020501VID	81
181385	466		20010301BLD	74		20012002VED	82		20018201	335	20020502	421
18138506	265		20010301BLD	78		20012002VID	82		20018201AC	233	20020502ACD	81
18138506	339		20010301BMD	74		20013001	423		20018201AM	233	20020502AMD	81
181403	446		20010301BMD	79		20013001	436		20018201BL	233	20020502BLD	81
181436	522		20010301D	420		20013001	436		20018201FU	233	20020502BMD	81
181437	529		20010301D	418		20016201	288		20018201NA	233	20020502FUD	81
181438	529		20010301FUD	74		20016201	426		20018201NE	233	20020502NAD	81
181468	449		20010301FUD	78		20016201AC	85		20018201RO	233	20020502NED	81
181474	449		20010301NAD	74		20016203	288		20018201VE	233	20020502ROD	81
181540	523		20010301NAD	78		20016203	426		20018201VI	233	20020502VED	81
181703	446		20010301NED	74		20016203AC	85		20018301	337	20020502VID	81
1818005	284		20010301NED	78		20016401	238		20019501	254	20020503	421
1818005	451		20010301ROD	74		20016401	426		20019501	427	20020503ACD	81
181903	444		20010301ROD	78		20016409	238		20019501AM	87	20020503AMD	81
181920	447		20010301VED	74		20016409	426		20019501BL	87	20020503BLD	81
183333	524		20010301VED	78		20016409AC	86		20019501FU	87	20020503BMD	81
183341	524		20010301VID	74		20016409AM	85		20019501NA	87	20020503FUD	81
183395	259		20010301VID	78		20016409BL	85		20019501NE	87	20020503NAD	81
183398	264		20010302	419		20016409BM	86		20019501RO	87	20020503NED	81
186103	444		20010302	418		20016409FU	85		20019501VE	87	20020503ROD	81
186120	447		20010302ACD	74		20016409NA	85		20019501VI	87	20020503VED	81
186203	445		20010302ACD	77		20016409NE	85		20020002	422	20020503VID	81

LISTA DI CODICI ARTICOLI / NUMERICAL LIST OF REFERENCES / ČÍSELNÝ SEZNAM KÓDŮ

Ref./Nr./Kód	Price	Page No.	Ref./Nr./Kód	Price	Page No.	Ref./Nr./Kód	Price	Page No.	Ref./Nr./Kód	Price	Page No.
20020504	421		20063604	348		20218003AC	31		20392001D	461	
20020504ACD	80		20063605	348		20218003AC	212		20410301	470	20517702
20020504AMD	80		20063606	348		20218005	311		20410301D	470	20518001
20020504BLD	80		20063607	348		20218006	30	20412001	470	20518001	438
20020504BMD	80		20063608	348		20218006B	212	20412001D	470	20518002	280
20020504FUD	80		20063609	349		20218006BL	30	20416701	470	20518002	438
20020504NAD	80		20063610	348		20218006NE	30	20417001	470	20518002	438
20020504NED	80		20063611	348		20218007	32	20417701	471	20518003	281
20020504ROD	80		20063612	348		20218080	311	20417702	285	20518003	439
20020504VED	80		20063613	349		20218080	212	20418001	471	20518003	439
20020504VID	80		20116701	194		20219101	29	20418002	285	20518004	281
20020505	421		20117701	194		20219501	34	20418002	471	20518005	281
20020505ACD	80		20117701	196		20219501BL	35	20418080	471	20518080	438
20020505AMD	80		20117702	196		20219501NE	35	20419601	239	20518080	438
20020505BLD	80		20117703	200		20220003	27	20419601	470	20518201	335
20020505BMD	80		20117704	197		20220003	100	20419601	480	20518301	337
20020505FUD	80		20118001	196		20220004	27	20419602	258	20520001	436
20020505NAD	80		20118002	196		20220004	100	20419603	239	20520001	436
20020505NED	80		20118003	199		20220004AC	27	20419603	472	20520001	538
20020505ROD	80		20118004	200		20220004AC	100	20419603	480	20520001AC	101
20020505VED	80		20118006	196		20224501	290	20438501	260	20520002	436
20020505VID	80		20118007	197		20231201	35	20438501	473	20520002	436
20020506	421		20119501	195		20238501	35	20438501	481	20520002	539
20020506ACD	80		20210301	25		20238502	36	20438701	257	20520002AC	101
20020506AMD	80		20210301ACD	26		20263604	344	20438701	473	20520040	436
20020506BLD	80		20210301BLD	26		20263605	344	20438701	480	20520040	436
20020506BMD	80		20210301D	25		20263607	344	20438702	285	20520041	436
20020506FUD	80		20210301NED	26		20263608	344	20438702	472	20520041	436
20020506NAD	80		20210302	24		20263609	344	20438703	257	20520041	538
20020506NED	80		20210302D	24		20263611	344	20438703	472	20520041AC	101
20020506ROD	80		20210303	25		20263612	344	20438703	480	20520070	436
20020506VED	80		20210303ACD	26		20263613	344	20438704	255	20520070	436
20020506VID	80		20210303BLD	26		20263901	230	20439501	255	20520071	436
20022401	423		20210303NED	26		20263901AC	230	20510301	433	20520071	436
20022401ACD	83		20210304	24		20266101	33	20510301	33	20520071	539
20022401AMD	83		20210305	25		20266102	33	20510301D	433	20520071AC	101
20022401BLD	83		20210305ACD	26		20298001	32	20510301D	433	20520501	434
20022401BMD	83		20210305BLD	26		20310301	458	20510302	432	20520501	434
20022401FUD	83		20210305NED	26		20310301D	458	20510302	432	20520502	434
20022401NAD	83		20210306	24		20310303	458	20510302D	432	20520502	434
20022401NED	83		20211001	27		20310303D	458	20510302D	432	20520503	434
20022401ROD	83		20211001BLD	27		20312001	461	20510303	433	20520503	434
20022401VED	83		20211001NED	27		20312001D	461	20510303	433	20522201	423
20022401VID	83		20211002	27		20312003	461	20510304	432	20522201	437
20024501	290		20211002BLD	27		20312003D	461	20510304	432	20522201	437
20024501	391		20211002NED	27		20313001	462	20510305	433	20522201	558
20024501	439		20212001	28		20316101	289	20510305	433	20522301	423
20024501	439		20212001ACD	28		20316101	465	20510306	432	20522301	437
20025001	242		20212001BLD	28		20316102	289	20510306	432	20522301	437
20025002	243		20212001D	28		20316102	465	20511201	434	20522301	558
20025003	243		20212001NED	28		20316701	463	20511201	434	20531201	262
20025004	243		20212002	28		20317001	463	20511202	546	20531201	441
20026010	422		20212002D	28		20317701	464	20511202	434	20531201	441
20031201	262		20216101	33		20317702	283	20511202	434	20538501	254
20031201	428		20216101AC	33		20318001	464	20511202	436	20538501	441
20044001	522		20216102	33		20318002	284	20512001	436	20538501	441
20044001AC	97		20216103	33		20318002	464	20512001	436	20539501	253
20044001AM	97		20216103AC	33		20318003	284	20512001D	436	20539501	441
20044001BL	97		20216104	33		20319101	274	20512001D	436	20539501	441
20044001FU	97		20216409	34		20319101	463	20512002	436	20544001	523
20044001NA	97		20216409AC	34		20320001	461	20512002	436	20544001AC	98
20044001NE	97		20216409BL	34		20320002	461	20512002D	436	20544001BM	98
20044001RO	97		20216409NE	34		20320301	459	20512002D	436	20547401	437
20044001VE	97		20216701	28		20320301D	459	20516101	287	20547401	437
20044001VI	97		20216701AC	28		20320701	459	20516101	439	20548601	521
20044002	523		20216701BL	28		20320701D	459	20516101	439	20548601AC	97
20044002AC	98		20216701NE	28		20321001	461	20516103	437	20548601BM	97
20044002AM	98		20217001	29		20321701	459	20516103	439	20548701	528
20044002BL	98		20217001AC	29		20321701D	459	20516103	439	20548701AC	100
20044002BM	98		20217001BL	29		20322401	290	205164019	238	20548701BM	100
20044002FU	98		20217001NE	29		20324501	291	205164019	440	20549501	252
20044002NA	98		20217409	34		20324501	410	205164019	440	20560301	435
20044002NE	98		20217409AC	34		20324501	426	20516701	437	20560301	435
20044002RO	98		20217409BL	34		20324501	452	20516701	437	20560301	548
20044002VE	98		20217409NE	34		20324501	465	20516801	437	20560302	435
20044002VI	98		20217701	29		20326010	461	20516801	437	20560302	435
20047501	322		20217702	29		20330301	460	20517001	437	20560302	548
20050301	403		20217703	30		20340301	460	20517001	437	20625191	150
20050301	422		20218001	29		20370301	460	205174019	240	20625199	148
20050301	434		20218002	29		20390301	458	205174019	440	20625201	152
20050301	434		20218003	31		20390301D	458	205174019	440	20625202	152
20050301AC	82		20218003	212		20392001	461	20517701	438	20625203	153

Ref./Nr./Kód	Price	Page No.	Ref./Nr./Kód	Price	Page No.	Ref./Nr./Kód	Price	Page No.	Ref./Nr./Kód	Price	Page No.	Ref./Nr./Kód	Price	Page No.
20625204	153		20735201BM	68		26115001	66		26218090	63		26290402ACD	58	
20625291	150		20735201TAM	68		26116209	66		26218099	65		26290402BMD	58	
20625299	148		20735201TBL	68		26116209AC	66		26220050	59		26290402TAMD	58	
20625301	157		20735201TFU	68		26116701	62		26220050AC	59		26290402TBLD	58	
20625302	157		20735201TNA	68		26116701AC	62		26220050BM	59		26290402TFUD	58	
20625391	150		20735201TNE	68		26116701BIM	62		26220050BTAM	59		26290402TNAD	58	
20625399	149		20735201TRO	68		26116701ITAM	62		26220050BTBL	59		26290402TNED	58	
20625491	150		20735201TVE	68		26116701ITBL	62		26220050BTFU	59		26290402TROD	58	
20625499	149		20735201TVI	68		26116701ITFN	62		26220050BTNA	59		26290402TVED	58	
20635191	151		20735202	69		26116701ITNA	62		26220050BTNE	59		26290402TVID	58	
20635199	148		20735202	120		26116701ITNE	62		26220050BTRO	59		26290403	58	
20635201	154		20735202AC	88		26116701ITRO	62		26220050BTVE	59		26290403ACD	58	
20635202	154		20735202AM	88		26116701ITRV	62		26220050BTVI	59		26290403BMD	58	
20635203	155		20735202BL	88		26116701ITVI	62		26220080	59		26290403TAMD	58	
20635204	156		20735202BM	88		26117001	62		26220080AC	59		26290403TBLD	58	
20635291	151		20735202FU	88		26117001AC	63		26220080BM	59		26290403TFUD	58	
20635299	148		20735202NA	88		26117001BIM	63		26220080BTAM	59		26290403TNAD	58	
20635301	158		20735202NE	88		26117001TAM	63		26220080BTBL	59		26290403TNED	58	
20635302	159		20735202RO	88		26117001ITBL	63		26220080BTFU	59		26290403TROD	58	
20635391	151		20735202VE	88		26117001ITFN	63		26220080BTNA	59		26290403TVED	58	
20635399	149		20735202VI	88		26117001ITNA	63		26220080BTNE	59		26290403TVID	58	
20635491	151		20735203	121		26117001ITRO	63		26220080BTRO	59		26298091	64	
20635499	149		20735204	122		26117001ITNE	63		26220080BTVE	59		26298091	213	
20718107	366		20735205	123		26117001ITRV	63		26220080BTVI	59		26298091AC	64	
20718201	163		20735206	125		26117001ITVI	63		26222402	62		26298091BM	64	
20718201	204		20735207	126		26117209	66		26222402ACD	62		26298091TAM	64	
20718201	203		20735208	125		26117209AC	66		26222402BMD	62		26298091TBL	64	
20718202	149		20735209	124		26121001	67		26222402TAMD	62		26298091TFU	64	
20718202	111		20735210	121		26130701	54		26222402TBLD	62		26298091TNA	64	
20718202	233		20735211	122		26130701ACD	55		26222402TFUD	62		26298091TNE	64	
20719201	118		20735212	123		26130701BMD	55		26222402TNAD	62		26298091TRO	64	
20725191	112		20735291	113		26130701TAMD	55		26222402TNED	62		26298091TVE	64	
20725192	112		20735292	113		26130701TBLD	55		26222402TROD	62		26298091TVI	64	
20725199	110		20735299	110		26130701TFUD	55		26222402TVED	62				
20725201	114		20735301	138		26130701TNAD	55		26222402TVID	62				
20725202	36		20735302	138		26130701TNEO	55		26230701	56		29911351	325	
20725202	114		20735303	141		26130701TRED	55		26230701ACD	57		29933703	304	
20725202AC	37		20735304	141		26130701TVID	55		26230701BMD	57		29933703VL	304	
20725202AC	49		20735305	144		26130701TFED	55		26230701ITAMD	57		29943202	298	
20725202BL	37		20735306	145		26130801	54		26230701ITBLD	57		29943203	298	
20725202BL	49		20735307	146		26130801ACD	55		26230701ITFU	57		29943204	299	
20725202NE	37		20735308	145		26130801BMD	55		26230701ITNAD	57		29943205	298	
20725202NE	49		20735308AC	145		26130801TAMD	55		26230701ITNEO	57		29951501	331	
20725203	115		20735309	139		26130801TBLD	55		26230701ITROD	57		29951502	331	
20725204	116		20735310	139		26130801TFUD	55		26230701ITVED	57		29951503	331	
20725205	117		20735311	140		26130801TNAD	55		26230701ITVID	57		29951504	232	
20725206	118		20735312	140		26130801TNEO	55		26230801	56		29951505	232	
20725207	119		20735391	128		26130801TROD	55		26230801ACD	57		29951506	232	
20725208	116		20735392	128		26130801TVED	55		26230801BMD	57		29951507	232	
20725209	117		20735399	111		26130801TVID	55		26230801TAMD	57		29951607	265	
20725210	115		20735401	142		26190301	54		26230801TAMD	57		29952505	328	
20725291	112		20735402	144		26190301ACD	55		26230801TFUD	57		29953202	301	
20725292	112		20735403	142		26190301BMD	55		26230801TNAD	57		29953203	301	
20725299	110		20735404	143		26190301D	54		26230801TNEO	57		29953204	300	
20725301	129		20735491	128		26190301TAMD	55		26230801TROD	57		29953205	301	
20725302	129		20735492	128		26190301TBLD	55		26230801TVED	57		29961001	374	
20725303	130		20735499	111		26190301TFUD	55		26230801TVID	57		29961002	374	
20725304	133		20739201	124		26190301TNAD	55		26231201	67		29961006	374	
20725305	136					26190301TNEO	55		26290301	56		29961003	327	
20725305AC	136					26190301TROD	55		26290301ACD	57		29961105	326	
20725306	136		21018107	366		26190301TVED	55		26290301BMD	57		29963106	326	
20725307	137		21027301	205		26190301TVID	55		26290301D	56		29963107	327	
20725309	130		21027302	205		26212001	61		26290301TAMD	57		29963107	252	
20725311	131		21027303	206		26212001D	61		26290301TBLD	57		29963108	252	
20725312	132		21027304	206		26215001	66		26290301TFUD	57		29963108	325	
20725313	132		21027305	207		26217790	63		26290301TNAD	57		29963201	202	
20725391	127		21027306	208		26217792	63		26290301TNEO	57		29963201	353	
20725392	127		21027307	209		26217793	64		26290301TROD	57		29963202	202	
20725399	111		21027308	207		26218003	65		26290301TVED	57		29963202	352	
20725401	134		21027309	208		26218003AC	66		26290301TVID	57		29963203	202	
20725402	133		21027310	209		26218003BM	66		26290401	58		29963203	352	
20725403	135		21027311	210		26218003TAM	66		26290401ACD	58		29963204	202	
20725404	135		21027312	210		26218003TBL	66		26290401BMD	58		29963204	353	
20725491	127		21027313	211		26218003TFU	66		26290401TAMD	58		29963205	303	
20725492	127		21027391	204		26218003TNA	66		26290401ITBLD	58		29963206	302	
20725499	111		21027399	204		26218003TNE	66		26290401TFUD	58		29963211	302	
20735191	113					26218003TRO	66		26290401TNAD	58		29963212	303	
20735192	113					26218003TVE	66		26290401TNEO	58		29963901	336	
20735199	110		26110501	60		26218003TVI	66		26290401TROD	58		29963902	304	
20735201	68		26110501AC	60		26218004	366		26290401TVED	58		29966310	252	
20735201	120		26112001	61		26218080	65		26290401TVID	58		29974802	374	
20735201AC	68		26112001D	61		26218080	213		26290402	58		29974802	326	

CONDIZIONI GENERALI DI VENDITA

Prezzi

I prezzi di questo listino e qualsiasi annesso che pubblicheremo dovranno considerarsi prezzi di vendita raccomandati per il cliente finale prima delle imposte.

I prezzi sono soggetti a qualsiasi variazione tenendo conto delle circostanze di mercato, materie prime, mano d'opera, imposte, etc, e si fattureranno secondo le condizioni al momento della spedizione.

Ordini

Si considereranno condizionali e soggetti pertanto alle nostre valutazioni.

Design

I nostri modelli potranno subire modifiche legate alle esigenze di design, senza avviso previo, sempre e comunque a beneficio dell'articolo stesso. La documentazione fotografica e/o il design tecnico riprodotto nel listino, catalogo, foglietti ed altri strumenti pubblicitari hanno un valore indicativo, perciò il cliente non potrà in nessun caso rifarsi ad essi nel caso di reclami a causa di differenze con i prodotti somministrati. Le reclamazioni dovranno realizzarsi come massimo, nei quindici giorni seguenti alla consegna della merce nel suo luogo di destinazione.

Termine di consegna

I nostri termini di consegna non sono vincolanti e non ci facciamo carico di eventuali ritardi e sue conseguenze.

Pagamenti

Gli importi fatturati, salvo accordi speciali, saranno onorati attraverso bonifico bancario come massimo a 30 giorni dalla data di emissione della fattura. Per termini superiori verranno applicati interessi. In caso in cui esistano debiti scaduti e non pagati, ci riserviamo il diritto di annullare gli ordini in corso.

Giurisdizioni

La buona FEDE che presiede le relazioni di TRES COMERCIAL, S.A. con tutti i suoi clienti e il nostro Desiderio di risolvere tutte le eventuali divergenze

per via amichevole non fanno pensare alle vie giudiziali come risoluzione delle divergenze.

Nonostante, si prevede in questo improbabile caso, sottomettere entrambe le parti ai tribunali di Barcellona con rinuncia espressa a qualsiasi altro foro.

Riserva di dominio

TRES comercial, S.A. sarà proprietaria di tutti i prodotti consegnati ai clienti fino al pagamento completo delle relative fatture.

Accettazione condizioni

Tutti gli ordini ricevuti, implicano la accettazione formale di queste condizioni a meno che si sia convenuto diverso accordo per iscritto.

MOLTO IMPORTANTE

Resi

TRES non accetterà nessun reso di merce, senza che previamente il nostro agente la abbia accettato e comunicato.

- 1) TRES NON ACCETTA NESSUN RESO senza accettazione previa (la merce si restituirà al mittente)
- 2) TRES NON ACCETTA NESSUN RESO di merce che possa essere riparata con Ricambi Originali.
- 3) TRES NON ACCETTA NESSUN RESO di merce al di fuori della garanzia.
- 4) Nonostante, in caso di ricevere merce perfettamente

imballata, essa sarà soggetta ad un deprezzamento in fattura di:

- Se é del anno in corso: -15% deprezzamento
- Se e' anteriore a due anni: -30% deprezzamento
- Se e' anteriore a tre anni: -60% deprezzamento

L'invio di merce dovrà effettuarsi a porto franco da parte del cliente.

GENERAL TERMS OF SALE

Prices

Prices do not include VAT and goods will be at your service in our warehouse.

Prices from price list and any appendix that we publish, must be considered "recommended sale prices for end user before taxes"

Prices are subject to variations depending on market circumstances, raw material, labour force, taxes, etc., and the invoices will be issued based on prices valid on the shipment day.

Orders

Orders will be considered conditional and, therefore, subject to our consideration.

Design

Our models could be changed as a result of design requirements, with no prior notice, always to benefit the product

The photographic documentation and/or technical design reproduced on the lists, catalogues, leaflets and another publicity media have just an indicative value, then the customer can not resort to them in case of possible claims for disagreement or differences on supplied products. The claims about nonconformity of products supplied must be done, as maximum, 15 days after to receive the merchandise.

Delivery time

Our delivery time is always rough and we do not take responsibility for the troubles than the delay may cause.

Payment

The invoices amount, unless special agreements must be paid by bank draft as maximum 30 days invoice date.

For upper payment terms will be charged financing.

In case that exist unpaid debt, we reserve the right to cancel the orders in process.

Jurisdiction

Due to the good faith governing the relations of TRES COMERCIAL, S.A. with all of its customers and our desire to resolve all differences by reconciliation, we consider that legal claims are not possible. Nevertheless we anticipate that improbable case, both parts agree to abide to Barcelona court with express waiver to any other jurisdiction.

Right of ownership

TRES Comercial, S.A. reserve the right of ownership of all products supplied to the customer, up to receive the complete invoice payment.

Conditions approval

All order received mean the formal approval of these conditions at least, written agreement to another one.

VERY IMPORTANT

Return of goods

TRES will not accept any return of goods without our agent has accepted it before and informed us.

- 1) TRES does not accept any devolution without previous acceptance (the goods will be returned to the sender)
- 2) TRES does not accept any return of good if it could be repair with original spare parts
- 3) TRES does not accept any product devolution out of guarantee.
- 4) Nevertheless, in case of receiving any goods in perfect conditions, the merchandise undergoes the following depreciation on invoice:

- If it is from the same year: - 15% depreciation
- If it is previous two years: - 30% depreciation
- If it is previous three years: - 60% depreciation

The merchandise' shipment must be done at carriage paid by the customer.

VŠEOBECNÉ PODMÍNKY PRODEJE

Ceny

Ceny nezahrnují daně a náklady na dopravu z našich skladů. Ceny uvedené v sazebníku a v každé ze zveřejněných příloh jsou považovány "doporučené prodejní ceny pro konečné zákazníky, bez daně". Ceny se mohou měnit dle situace na trhu, surovinových nákladů, ceny práce, výše daní a jiných okolností, faktury budou vystavovány se zohledněním cen platných ke dni vystavení.

Objednávky

Pro jejich platnost je nutné, aby byly námi předem potvrzeny.

Design

Typy našich produktů se mohou měnit z technických důvodů a bez předchozího oznámení, vždy se bude jednat o změny příznivé pro daný sortiment. Fotografická dokumentace nebo technické výkresy uvedené na kartách produktů, v katalozích, letáčích a jiných reklamních materiálech mají výhradně informační charakter. Zákazníci se v této souvislosti nemohou odvolávat na rozdíly mezi nabídkou a dodaným produktem a tyto reklamovat. Reklamacie týkající se nesouladu dodaného produktu nutno uplatnit nejpozději ve lhůtě dvou týdnů ode dne dodání produktu na místo určení.

Dodací lhůty

Námi uváděné dodací lhůty jsou výhradně přibližnými termíny, z tohoto důvodu neneseme zodpovědnost za následky způsobené jakéhokoliv zpožděním.

Platby

Kromě speciálních smluv budou veškeré platby prováděny převodem nejpozději ve lhůtě do 30 dnů ode vystavení faktury. V případě plateb realizovaných po této lhůtě budou účtovány dodatečné poplatky. V případě prodlení plateb po lhůtě splatnosti si vyhrazujeme právo odmítnout vyřízení dalších objednávek.

Giurisdiziones

Pravidlo postupu v dobré víře je základem vztahů mezi TRES COMERCIAL, S.A. a jejími zákazníky a doufáme, že veškeré sporné záležitosti se nám podaří vyřešit smírem bez nutnosti řešení soudní cestou. Pokud by to nebylo možné, obě strany souhlasí s příslušností soudů v Barceloně a vědomě se vzdávají každé jiné příslušnosti soudů.

Ustanovení týkající se vlastnictví

TRES comercial, S.A. zůstává majitelem veškerých produktů dodaných zákazníkovi až do dne provedení úplné úhrady faktury.

Schválení podmínek

Každá obdržená objednávka znamená, že odběratel akceptuje výše uvedené podmínky, nestanoví-li strany odlišné v písemné formě.

VELMI DŮLEŽITÉ

Vratky zboží

TRES nepřijímá žádné vratky zboží bez předchozího souhlasu a příslušné informace ze strany našeho zástupce.

- 1) TRES NEPŘIJÍMÁ ŽÁDNÉ VRATKY zboží bez předchozího odsouhlasení. (Zboží bude vráceno odeslateli)
- 2) TRES NEPŘIJÍMÁ ŽÁDNÉ VRATKY zboží, které by bylo možno opravit s použitím originálních náhradních dílů.
- 3) TRES NEPŘIJÍMÁ ŽÁDNÉ VRATKY zboží po vypršení záruční lhůty.
- 4) V případě vrácení zboží v původním balení bude cena zboží snížena podle ceny uvedené na faktuře takto:

- Je-li faktura z běžného roku:	-15% snížení ceny
- Je-li faktura starší dvou let:	-30% snížení ceny
- Je-li faktura starší tří let:	-60% snížení ceny

Náklady na odeslání zboží hradí zákazník.



Vernici ecologiche senza solventi / **Eco-friendly solvent-free paints** / Ekologické barvy, bez rozpouštědel
 ORDINE SPECIALE - Tempi di consegna di 4 Settimane / **SPECIAL ORDER - Delivery time of 4 weeks** / ZVLÁŠTNÍ OBJEDNÁVKA - Dodací lhůta 4 týdny

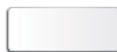

Bianco opaco
Matte white
 Matná biela



Nero
Black
 Černá



Bianco
Withe
 Bílá



Ambra
Amber
 Jantarová



Arancio
Orange
 Oranžová



Rosso
Red
 Červená



Viola
Violet
 Fialová



Fucsia
Fuchsia
 Fuchsiová



Verde
Green
 Zelená



Nero-Cromo
Black-chrome
 Černá-chromová



Bianco-Cromo
White-chrome
 Bílá-chromová



Ambra-cromo
Amber-chrome
 Jantarová-chromová



Arancio-cromo
Orange-chrome
 Oranžová-chromová



Rosso-cromo
Red-chrome
 Červená-chromová



Viola-cromo
Violet-chrome
 Fialová-chromová



Fucsia-cromo
Fuchsia-chrome
 Fuchsiová-chromová



Verde-cromo
Green-chrome
 Zelená-chromová



Acciaio
Staal
 Kartáčovaná ocel



Rame
Copper
 Stará měď



Ottone Antico
Old Brass
 Stará Mosaz



Acciaio inossidabile
Stainless steel
 Nerezová ocel







Cromo
Chrome
 Chrom





Anodizzato
Anodized
 Anodizovaný



-  Scatola individuale N°2 (200x150x80) Scatola generale 8 unità
Single Box 2 (200x150x80) 8-units general box
Jednodílná krabice 2 (200x150x80) Všeobecný fond 8 jednotek
-  Scatola individuale N°3 (160x150x80) Scatola generale 10 unità
Single Box 3 (160x150x80) 10-units general box
Jednodílná krabice 3 (160x150x80) Všeobecný fond 10 jednotek
-  Scatola individuale N°5 (300x160x80) Scatola generale 5 unità
Single Box 5 (300x160x80) 5-units general box
Jednodílná krabice 5 (300x160x80) Všeobecný fond 5 jednotek
-  Scatola individuale N°9 (163x80x75) Scatola generale 20 unità
Single Box 9 (163x80x75) 20-units general box
Jednodílná krabice 9 (163x80x75) Všeobecný fond 20 jednotek
-  Scatola individuale N°10 (132x83x60) Scatola generale 30 unità
Single Box 10 (132x83x60) 30-units general box
Jednodílná krabice 10 (132x83x60) Všeobecný fond 30 jednotek



General Box
(310x170x410)

-  Scatola individuale N°6 (200x170x160) Scatola generale 8 unità
Single Box 6 (200x170x160) 8-units general box
Jednodílná krabice 6 (200x170x160) Všeobecný fond 8 jednotek
-  Scatola individuale N°14 Scatola generale 3 unità
Single Box 14 3-units general box
Jednodílná krabice 14 Všeobecný fond 3 jednotek
-  Scatola individuale N°11 (310x195x165) Scatola generale 4 unità
Single Box 11 (310x195x165) 4-units general box
Jednodílná krabice 11 (310x195x165) Všeobecný fond 4 jednotek







General Box
(345x405x330)

-  Scatola individuale N°7 (310x195x105) Scatola generale 6 unità
Single Box 7 (310x195x105) 6-units general box
Jednodílná krabice 7 (310x195x105) Všeobecný fond 6 jednotek



General Box
(405x325x325)

-  Scatola individuale N°1 (400x200x80) Scatola generale 6 unità
Single Box 1 (400x200x80) 6-units general box
Jednodílná krabice 1 (400x200x80) Všeobecný fond 6 jednotek
-  Scatola individuale N°4 (400x120x80) Scatola generale 10 unità
Single Box 4 (400x120x80) 10-units general box
Jednodílná krabice 4 (400x120x80) Všeobecný fond 10 jednotek
-  Scatola individuale N°8 (465x285x95) Scatola generale 4 unità
Single Box 8 (465x285x95) 4-units general box
Jednodílná krabice 8 (465x285x95) Všeobecný fond 4 jednotek
-  Scatola individuale N°12 Scatola generale 2 unità
Single Box 12 2-units general box
Jednodílná krabice 12 Všeobecný fond 2 jednotek



General Box
(410x250x410)

-  Scatola individuale N°13 (460x285x95) Scatola generale 4 unità
Single Box 13 (460x285x95) 4-units general box
Jednodílná krabice 13 (460x285x95) Všeobecný fond 4 jednotek



General Box
(475x294x398)

Scatola individuale BARRA LUXUS (79x55x610)
Scatola generale 24 unità

Single Box BARRA LUXUS (79x55x610)
24-units general box

Jednodílná krabice BARRA LUXUS (79x55x610)
Všeobecný fond 24 jednotek

Scatola individuale BARRA SUPRA (115x110x740)
Scatola generale 9 unità

Single Box BARRA SUPRA (115x110x740)
9-units general box

Jednodílná krabice BARRA SUPRA (115x110x740)
Všeobecný fond 9 jednotek

Scatola individuale KIT BARRA-DUCHA (220x75x665)
Scatola generale 6 unità

Single Box KIT BARRA-DUCHA (220x75x665)
6-units general box

Jednodílná krabice KIT BARRA-DUCHA (220x75x665)
Všeobecný fond 6 jednotek



General Box
(355x380x750)



Before purchasing taps and showers always ensure your site conditions meet the minimum operating pressure requirements. Please consult your plumber.

Minimum Operating Pressure					
Washbasin Mixer	Bidet Mixer	Conc Shower Mixer	Conc Bath Shower Mixer	Shower	Bath Shower
0,5 bar * excepted the Open Fall (1,5 bar)	0,5 bar	0,5 bar	0,5 bar	0,5 bar	2 bar
Built In	Thermostatically-controlled shower	Thermostatically-controlled bathtube	Thermostatically-controlled shower sets	Thermostatically-controlled bathtube sets	Classic Thermostatic control set
1 bar	0,5 bar	2 bar	2 bar	2 bar	0,5 bar
Kitchen					
0,5 bar					
Showers					
please refer to the flow and bar indicated on the shower section					
Washbasin Mixer	Bidet Mixer	Conc Shower Mixer	Conc Bath Shower Mixer	Shower	Bath Shower
0,5 bar	0,5 bar	0,5 bar	0,5 bar	0,5 bar	2 bar

CONVERSION

All measures are in millimeters. For equivalent in inches multiply by 0.0394

LENGTH

mm	in
1	0.039
5	0.197
10	0.394
25	0.984
50	1.969
100	3.937

cm	in
1	0.394
5	1.969
10	3.937
25	9.843
50	19.685
100	39.370

in	mm
1	25,4
2.5	63,5
5	127

ft	mm
1	304,8
2.5	762
5	1.524

PRESSURE

psi	bar
60	4,137
80	5,515

bar	psi
0,5	7.25
1	14.505
3	43.511
5	72,519

VOLUMETRIC FLOW RATE

l/m	GPM
1	0.264
1,5	0.396
1,75	0.462
2	0.528
2,2	0.581
2,5	0.660
5	1.321

GPM	l/m
1	3,785
1.5	5,678
1.75	6,624
2	7,570
2.2	8,328
2.5	9,463
5	18,927

TEMPERATURE

°C	°F
38	100.4
70	158

Installazione consigliata.
Installation recommended.
Doporučená instalace.

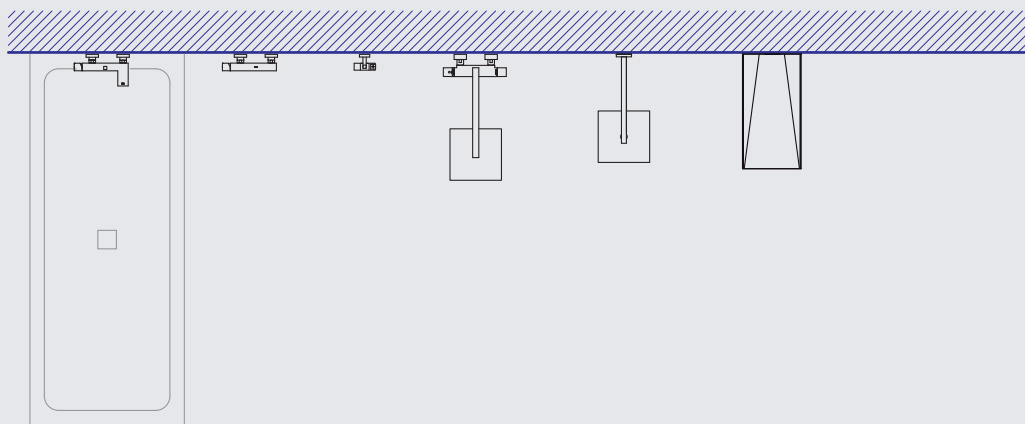
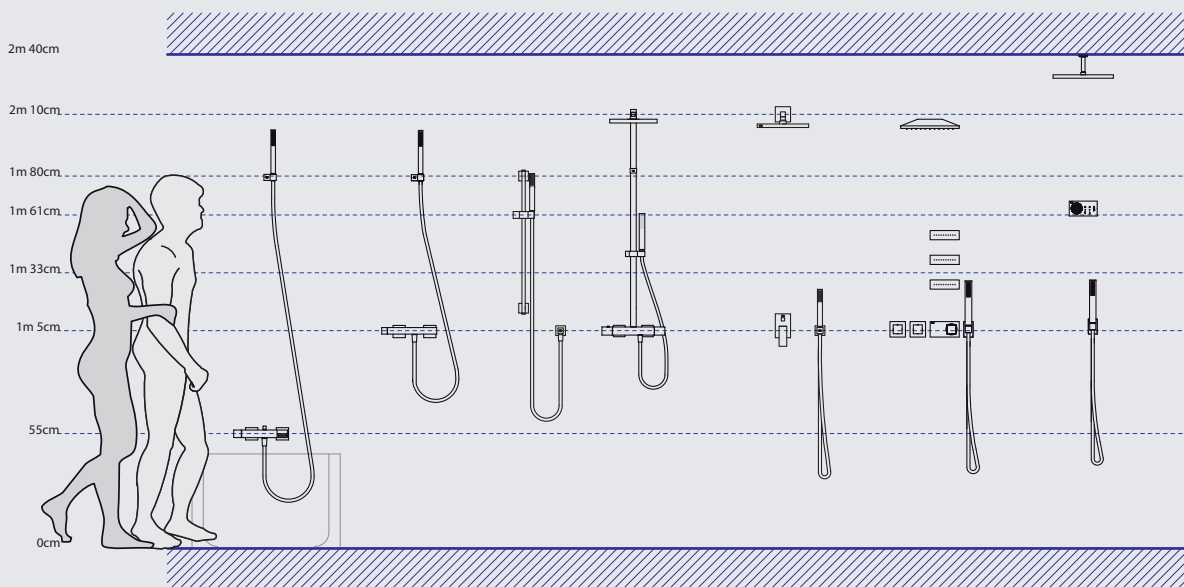

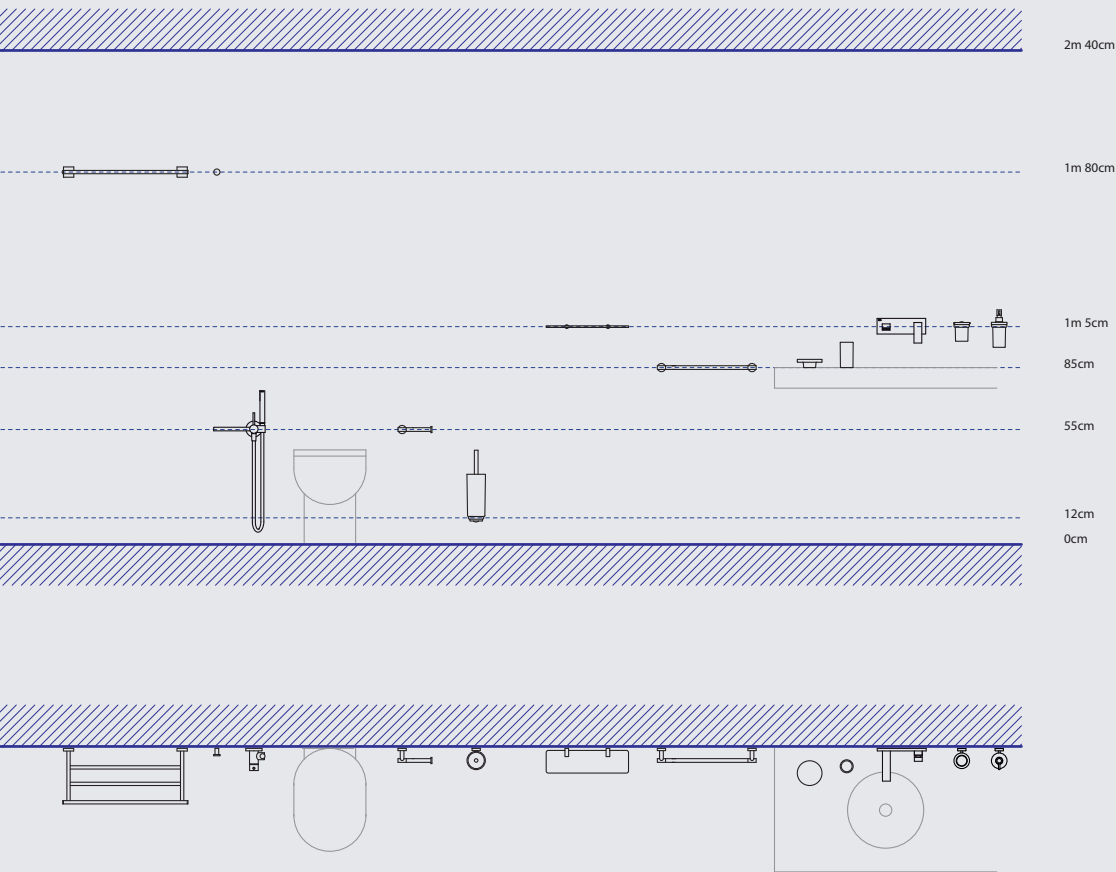

INFORMAZIONI

Scarichi doccia

Nella doccia sarà possibile utilizzare contemporaneamente due uscite dell'acqua, a condizione che lo scarico sia stato progettato allo scopo. (Si raccomanda l'uso dello scarico Ref.: 1.04.840).

Fornitura dell'acqua

Ogni prodotto richiede una pressione diversa a seconda del flusso, sebbene sia sufficiente una pressione dinamica compresa tra 2 e 3 bar. La pressione dinamica viene misurata con il rubinetto aperto.

Rubineria incassata

Questi prodotti incassati offrono l'enorme vantaggio di occupare meno spazio nelle docce piccole e di essere più facili da pulire.

INFORMATION

Shower drains

A shower may be equipped with two water outlets, as long as the drain has been designed to permit this (We recommend drain: Nr. 1.04.840).

Water supply

Different products have different pressure and flow requirements, but a dynamic pressure of between 2 and 3 bar should be sufficient. Dynamic pressure is measured with the tap turned on.

Built-in taps

The great advantage of these built-in products is the extra space they provide in small showers. They are also much easier to clean.

INFORMACE

Sprchové odtoky

Ve sprše bude možné použít dva výstupy vody zároveň, avšak pokud je k tomu odtok správně nadimenzován. (Doporučujeme odtok kód: 1.04.840)

Dodávka vody

Různé výrobky potřebují různý tlak s rozdílným průtokem, dynamický tlak mezi 2 až 3 bary však postačí. Tento dynamický tlak se měří s otevřeným kohoutkem.

Vestavěné baterie

Vestavěné baterie mají velkou výhodu v tom, že šetří prostor v malých sprchách a snadněji se čistí.

TRES

C/ Penedès, 16-26
Zona Industrial, Sector A
08759 VALLIRANA (Barcelona)

TEL. (34) 93 683 40 27
FAX. (34) 93 683 50 61
exporttres@tresgriferia.com

www.tresgriferia.com



REF. 7342017040 / Ed. 01-2017